

©2019 Yamaha Motor Corporation, U.S.A.

F200
LF200
F225
F250
LF250

OWNER'S MANUAL

 Read this manual carefully before operating this outboard motor.

LIT-18626-10-34
6AL-28199-34-E0

⚠ WARNING

The engine exhaust from this product contains chemicals known to the State of California to cause cancer, birth defects or other reproductive harm.

YAMAHA

LIT-CALIF-65-01

Les gaz d'échappement du moteur de ce produit contiennent des substances chimiques connues dans l'État de Californie pour provoquer le cancer, des anomalies congénitales et des troubles de la reproduction.

ZMU07696

Read this manual carefully before operating this outboard motor. Keep this manual onboard in a waterproof bag when boating. This manual should stay with the outboard motor if it is sold.

Important manual information

EMU44141

To the owner

Thank you for selecting a Yamaha outboard motor. This Owner's Manual contains information needed for proper operation, maintenance and care. A thorough understanding of these simple instructions will help you obtain maximum enjoyment from your new Yamaha. If you have any question about the operation or maintenance of your outboard motor, please consult a Yamaha dealer.

In this Owner's Manual particularly important information is distinguished in the following ways.

 : This is the safety alert symbol. It is used to alert you to potential personal injury hazards. Obey all safety messages that follow this symbol to avoid possible injury or death.

EWM00782

WARNING

A WARNING indicates a hazardous situation which, if not avoided, could result in death or serious injury.

ECM00702

NOTICE

A NOTICE indicates special precautions that must be taken to avoid damage to the outboard motor or other property.

TIP:

A TIP provides key information to make procedures easier or clearer.

Yamaha continually seeks advancements in product design and quality. Therefore, while this manual contains the most current product information available at the time of printing, there may be minor discrepancies

between your machine and this manual. If there is any question concerning this manual, please consult your Yamaha dealer.

To ensure long product life, Yamaha recommends that you use the product and perform the specified periodic inspections and maintenance by correctly following the instructions in the owner's manual. Any damage resulting from neglect of these instructions is not covered by warranty.

Some countries have laws or regulations restricting users from taking the product out of the country where it was purchased, and it may be impossible to register the product in the destination country. Additionally, the warranty may not apply in certain regions. When planning to take the product to another country, consult the dealer where the product was purchased for further information.

If you purchased this outboard motor used, see your Yamaha dealer to have it registered in your name in Yamaha records.

TIP:

The F200A, LF200A, F225A, F250A, LF250A and the standard accessories are used as a base for the explanations and illustrations in this manual. Therefore some items may not apply to every model.

EMU44151

**F200, LF200, F225, F250, LF250
OWNER'S MANUAL**

**©2013 by Yamaha Motor Co., Ltd.
1st Edition, October 2013**

All rights reserved.

**Any reprinting or unauthorized use
without the written permission of
Yamaha Motor Co., Ltd.
is expressly prohibited.**

Printed in Japan

Table of contents

Safety information	1	Specifications and requirements	13
Outboard motor safety.....	1	Specifications	13
Propeller.....	1	Installation requirements	14
Rotating parts.....	1	Boat horsepower rating.....	14
Hot parts	1	Mounting outboard motor	15
Electric shock.....	1	Remote control requirements	15
Power trim and tilt	1	Battery requirements	15
Engine shut-off cord (lanyard).....	1	Specifications of Battery	15
Gasoline	2	Mounting battery	15
Gasoline exposure and spills	2	Multiple batteries.....	16
Carbon monoxide	2	Propeller selection	16
Modifications.....	2	Counter rotation models	16
Boating safety	2	Start-in-gear protection	16
Alcohol and drugs	2	Engine oil requirements	17
Personal flotation devices (PFDs)	2	Fuel requirements	17
People in the water	2	Gasoline	17
Passengers.....	2	Gasoline Additives.....	19
Overloading	2	Anti-fouling paint	19
Avoid collisions	3	Outboard motor disposal	
Weather	3	requirements.....	20
Accident reporting.....	3	Emergency equipment.....	20
Boat education and training	3	Emission control information	20
Passenger training	4	Star labels	21
Boating safety publications.....	4	Components	23
Laws and regulations	4	Components diagram	23
Boating organizations	4	Remote control box.....	24
Basic boating rules (Rules of the road)	5	Remote control lever	25
Steering and sailing rules and sound signals.....	5	Free accelerator	25
Rules when encountering vessels.....	5	Throttle friction adjuster	26
Other special situations.....	6	Engine shut-off cord (lanyard) and clip	26
General information	9	Main switch	27
Identification numbers record	9	Power trim and tilt switch on remote control	27
Outboard motor serial number.....	9	Power trim and tilt switch on bottom cowling.....	27
Key number	9	Power trim and tilt switches (twin binnacle type).....	28
C-Tick label	9	Trim tab with anode	28
Read manuals and labels.....	10	Tilt support lever for power trim and tilt model	29
Warning labels	10		

Table of contents

Cowling lock lever (pull up type)	29	Installation	46
Flushing device	30	Installation.....	46
Fuel filter/Water separator.....	30	Mounting the outboard motor	46
Instruments and indicators	32	Operation.....	48
Digital tachometer	32	First-time operation	48
Tachometer	32	Fill engine oil.....	48
Trim meter	32	Breaking in engine.....	48
Hour meter	32	Getting to know your boat	48
Low oil pressure-alert indicator.....	33	Checks before starting engine.....	48
Overheat-alert indicator	33	Fuel level	49
Digital speedometer	33	Remove cowling.....	49
Speedometer.....	33	Fuel system	49
Fuel gauge.....	34	Controls.....	50
Trip meter / Clock / Voltmeter.....	34	Engine shut-off cord (lanyard)	50
Fuel level-alert indicator	35	Engine oil.....	50
Low battery voltage-alert indicator	35	Engine	50
Fuel management meter	35	Flushing device	50
Fuel flow meter.....	35	Install cowling.....	51
Fuel consumption meter / Fuel economy meter / Twin engine speed synchronizer.....	36	Checking power trim and tilt system.....	52
Water separator-alert indicator	38	Battery.....	53
6Y8 Multifunction meters	38	Filling fuel	53
6Y8 Multifunction tachometers	38	Operating engine	53
Start-up checks.....	39	Sending fuel	54
Low oil pressure-alert.....	39	Starting engine	54
Overheat alert.....	40	Checks after starting engine.....	55
Water separator alert.....	40	Cooling water	55
Engine trouble alert	40	Warming up engine.....	56
Low battery voltage-alert	41	Electric start models.....	56
6Y8 Multifunction speed & fuel meters	41	Checks after engine warm up.....	56
6Y8 Multifunction speedometers	42	Shifting	56
6Y8 Multifunction fuel management meters	43	Stop switches.....	56
Engine control system	44	Shifting.....	56
Alert system	44	Stopping boat	57
Overheat alert.....	44	Stopping engine.....	57
Low oil pressure alert.....	44	Procedure.....	57
		Trimming outboard motor.....	58
		Adjusting trim angle (Power trim and tilt)	58
		Adjusting boat trim	59
		Tilting up and down	60
		Procedure for tilting up.....	60

Table of contents

Procedure for tilting down.....	62	Running single engine (twin engines).....	92
Shallow water	62	Replacing fuse.....	93
Power trim and tilt models	62	Power trim and tilt will not operate.....	94
Operating in other conditions	63	Water separator-alert indicator blinks while cruising.....	94
Maintenance	64	Treatment of submerged motor....	96
Transporting and storing outboard motor.....	64	Consumer information (For North America).....	97
Storing outboard motor.....	64	YAMAHA FOUR-STROKE OUTBOARD MOTOR THREE-YEAR LIMITED WARRANTY	97
Conditioning and stabilizing gasoline.....	65	IMPORTANT WARRANTY INFORMATION IF YOU USE YOUR YAMAHA OUTSIDE THE U.S.A. OR CANADA.....	99
Procedure.....	65	INDEX.....	100
Lubrication	66		
Cleaning and anticorrosion measures	66		
Flushing power unit.....	67		
Cleaning the outboard motor.....	67		
Checking painted surface of outboard motor.....	68		
Periodic maintenance	68		
Replacement parts	68		
Maintenance interval guidelines.....	68		
Maintenance chart 1	69		
Maintenance chart 2	71		
Greasing.....	72		
Cleaning and adjusting spark plug... ..	74		
Inspecting idle speed	75		
Changing engine oil.....	75		
Inspecting wiring and connectors....	79		
Checking propeller	80		
Removing propeller	80		
Installing propeller	81		
Changing gear oil	82		
Inspecting and replacing anode(s) ...	85		
Checking battery (for electric start models)	85		
Connecting the battery.....	86		
Disconnecting the battery	87		
Trouble Recovery	89		
Troubleshooting	89		
Temporary action in emergency ...	92		
Impact damage	92		

EMU33623

Outboard motor safety

Observe these precautions at all times.

EMU336502

Propeller

People can be injured or killed if they come in contact with the propeller. The propeller can keep moving even when the motor is in neutral, and sharp edges of the propeller can cut even when stationary.

- Stop the engine when a person is in the water near you.
- Keep people out of reach of the propeller, even when the engine is off.

EMU40272

Rotating parts

Hands, feet, hair, jewelry, clothing, personal flotation device (PFD) straps, etc., can become entangled with internal rotating parts of the engine, resulting in serious injury or death.

Keep the top cowling in place whenever possible. Do not remove or replace the top cowling with the engine running.

Only operate the engine with the top cowling removed according to the specific instructions in the manual. Keep hands, feet, hair, jewelry, clothing, PFD straps, etc., away from any exposed moving parts.

EMU33641

Hot parts

During and after operation, engine parts are hot enough to cause burns. Avoid touching any parts under the top cowling until the engine has cooled.

EMU33651

Electric shock

Do not touch any electrical parts while starting or operating the engine. They can cause shock or electrocution.

EMU33661

Power trim and tilt

Body parts can be crushed between the motor and the clamp bracket when the motor is trimmed or tilted. Keep body parts out of this area at all times. Be sure no one is in this area before operating the power trim and tilt mechanism.

The power trim and tilt switches operate even when the main switch is off. Keep people away from the switches whenever working around the motor.

Never get under the lower unit while it is tilted, even when the tilt support lever is locked. Severe injury could occur if the outboard motor accidentally falls.

EMU33672

Engine shut-off cord (lanyard)

Attach the engine shut-off cord so that the engine stops if the operator falls overboard or leaves the helm. This prevents the boat from running away under power and leaving people stranded, or running over people or objects.

Always attach the engine shut-off cord to a secure place on your clothing or your arm or leg while operating. Do not remove it to leave the helm while the boat is moving. Do not attach the cord to clothing that could tear loose, or route the cord where it could become entangled, preventing it from functioning.

Do not route the cord where it is likely to be accidentally pulled out. If the cord is pulled during operation, the engine will shut off and you will lose most steering control. The boat could slow rapidly, throwing people and objects forward.

Safety information

EMU33811

Gasoline

Gasoline and its vapors are highly flammable and explosive. Always, refuel according to the procedure on page 53 to reduce the risk of fire and explosion.

EMU33821

Gasoline exposure and spills

Take care not to spill gasoline. If gasoline spills, wipe it up immediately with dry rags. Dispose of rags properly.

If any gasoline spills onto your skin, immediately wash with soap and water. Change clothing if gasoline spills on it.

If you swallow gasoline, inhale a lot of gasoline vapor, or get gasoline in your eyes, get immediate medical attention. Never siphon fuel by mouth.

EMU33901

Carbon monoxide

This product emits exhaust gases which contain carbon monoxide, a colorless, odorless gas which may cause brain damage or death when inhaled. Symptoms include nausea, dizziness, and drowsiness. Keep cockpit and cabin areas well ventilated. Avoid blocking exhaust outlets.

EMU33781

Modifications

Do not attempt to modify this outboard motor. Modifications to your outboard motor may reduce safety and reliability, and render the outboard unsafe or illegal to use.

EMU33741

Boating safety

This section includes a few of the many important safety precautions that you should follow when boating.

EMU33711

Alcohol and drugs

Never operate after drinking alcohol or taking drugs. Intoxication is one of the most common factors contributing to boating fatalities.

EMU40281

Personal flotation devices (PFDs)

Have an approved PFD on board for every occupant. Yamaha recommends that you must wear a PFD whenever boating. At a minimum, children and non-swimmers should always wear PFDs, and everyone should wear PFDs when there are potentially hazardous boating conditions.

EMU33732

People in the water

Always watch carefully for people in the water, such as swimmers, skiers, or divers, whenever the engine is running. When someone is in the water near the boat, shift into neutral and stop the engine.

Stay away from swimming areas. Swimmers can be hard to see.

The propeller can keep moving even when the motor is in neutral. Stop the engine when a person is in the water near you.

EMU33752

Passengers

Consult your boat manufacturer's instructions for details about appropriate passenger locations in your boat and be sure all passengers are positioned properly before accelerating and when operating above an idle speed. Standing or sitting in non-designated locations may result in being thrown either overboard or within the boat due to waves, wakes, or sudden changes in speed or direction. Even when people are positioned properly, alert your passengers if you must make any unusual maneuver. Always avoid jumping waves or wakes.

EMU33762

Overloading

Do not overload the boat. Consult the boat capacity plate or boat manufacturer for maximum weight and number of passengers. Be sure that weight is properly distributed according to the boat manufacturer's instruc-

tions. Overloading or incorrect weight distribution can compromise the boats handling and lead to an accident, capsizing or swamping.

EMU33773

Avoid collisions

Scan constantly for people, objects, and other boats. Be alert for conditions that limit your visibility or block your vision of others.

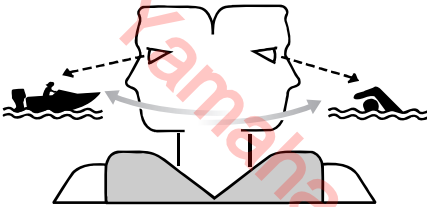

ZMU06025

Operate defensively at safe speeds and keep a safe distance away from people, objects, and other boats.

- Do not follow directly behind other boats or waterskiers.
- Avoid sharp turns or other maneuvers that make it hard for others to avoid you or understand where you are going.
- Avoid areas with submerged objects or shallow water.
- Ride within your limits and avoid aggressive maneuvers to reduce the risk of loss of control, ejection, and collision.
- Take early action to avoid collisions. Remember, boats do not have brakes, and stopping the engine or reducing throttle can reduce the ability to steer. If you are not sure that you can stop in time before hitting an obstacle, apply throttle and turn in another direction.

EMU33791

Weather

Stay informed about the weather. Check weather forecasts before boating. Avoid boating in hazardous weather.

EMU44161

Accident reporting

Boat operators are required by law to file a Boating Accident Report with their boating law enforcement agency if their boat is involved in any of the following accidents:

1. There is loss of life or probable loss of life.
2. There is personal injury that requires medical attention beyond first aid.
3. There is property damage to boats or other property over a certain amount.
4. There is complete loss of a boat.

Contact local law enforcement personnel if a report is necessary.

EMU44171

Boat education and training

For U.S.A.

Operators should take a boating safety course. This may be required in your state. Many of the organizations listed in the next section can provide information about courses in your area.

You may also want to consider an Internet-based program for basic boater education. The Online Boating Safety Course provided by the BoatU.S. Foundation, is approved by the National Association of State Boating Law Administrators (NASBLA) and recognized by the United States Coast Guard. Most, but not all, states accept this course to meet their minimum requirements. While it cannot replace an in-depth course such as one offered by the U.S. Coast Guard, U.S. Power Squadron, or other organization, this online course does provide a general overview of the basics in boating safety, requirements, navigation, and operation. Upon

Safety information

successful completion of the course, the user can download a certificate of completion immediately or, for a small charge, request one by mail. To take this free course, go to boatus.org.

For Canada

All operators of pleasure craft must illustrate competency by means of a Pleasure Craft Operators Card with the exception of Personal Water Craft used for rental purposes which require a rental checklist be completed. Pleasure Craft Operators Cards can be obtained following the completion of a competency course, with an on-line option. Details can be found on Transport Canada's website. www.tc.gc.ca

EMU33881

Passenger training

Make sure at least one other passenger is trained to operate the boat in the event of an emergency.

EMU33891

Boating safety publications

Be informed about boating safety. Additional publications and information can be obtained from many boating organizations.

EMU33591

Laws and regulations

Know the marine laws and regulations where you will be boating- and obey them. Several sets of rules prevail according to geographic location, but all are basically the same as the International Rules of the Road. The rules presented in the following section are condensed- and have been provided for your convenience only.

Contact the U.S. Coast Guard, the National Association of State Boating Law Administrators, or your local Power Squadron for a complete set of rules governing the waters in which you will be using your boat.

EMU44740

Boating organizations

The following organizations provide boating safety training and information about boating safety and laws.

In the U.S.A.

United States Coast Guard

Consumer Affairs Staff (G-BC)
Office of Boating, Public, and Consumer Affairs
U.S. Coast Guard Headquarters
Washington, D.C. 20593-0001
<http://www.uscgbloating.org/>

United States Power Squadrons

1-888-FOR-USPS (1-888-367-8777)
<http://www.usps.org/>

Boat Owners Association of The United States

1-800-336-BOAT (1-800-336-2628)
<http://www.boatus.com/>

National Association of State Boating Law Administrators (NASBLA)

1500 Leestown Road, Suite 330
Lexington, KY 40511 859-225-9497
<http://www.nasbla.org/>

National Marine Manufacturers Association (NMMA)

200 East Randolph Drive
Suite 5100
Chicago, IL 60601
<http://www.nmma.org/>

Marine Retailers Association of America

155 N. Michigan Ave. Chicago,
IL 60304
<http://www.mraa.com/>

In Canada

National Marine Manufacturers Association Canada

14 McEwan Drive
Suite 8
Bolton, ON
L7E 1H1
<http://www.nmma.org/>

In Australia

Boating Industry Association of Australia

<http://www.biaa.com.au/>

In New Zealand

NZ Marine Industry Association

<http://www.nzmarine.com/>

EMU33692

Basic boating rules (Rules of the road)

Just as there are rules that apply when you are driving on streets and highways, there are waterway rules that apply when you are driving your boat. These rules are used internationally. (For U.S.A.: and are also enforced by the United States Coast Guard and local agencies.) You should be aware of these rules, and follow them whenever you encounter another vessel on the water.

EMU33701

Steering and sailing rules and sound signals

Whenever two vessels on the water meet one another, one vessel has the right-of-way; it is called the “stand-on” vessel. The vessel that does not have the right-of-way is called the “give-way” or “burdened” vessel. These rules determine which vessel has the right-of-way, and what each vessel should do.

Stand-on vessel

The vessel with the right-of-way has the duty to continue its course and speed, except to avoid an immediate collision. When you maintain your direction and speed, the other vessel will be able to determine how best to avoid you.

Give-way vessel

The vessel that does not have the right-of-way has the duty to take positive and timely action to stay out of the way of the Stand-On vessel. Normally, you should not cross in front of the vessel with the right-of-way. You should slow down or change directions briefly and pass behind the other vessel. You should always move in such a way that the operator of the other vessel can see what you are doing.

“ The general prudential rule ”

This rule is called Rule 2 in the International Rules and says,

“ In obeying and construing these rules due regard shall be had to all dangers of navigation and collision, and to any special circumstances, which may render a departure from the above rules necessary in order to avoid immediate danger.”

In other words, follow the standard rules except when a collision will occur unless both vessels try to avoid each other. If that is the case, both vessels become “ Give-Way ” vessels.

EMU25522

Rules when encountering vessels

There are three main situations that you may encounter with other vessels which could lead to a collision unless the Steering Rules are followed:

Meeting: (you are approaching another vessel head-on)

⚠ Safety information

Crossing: (you are traveling across the other vessel's path)

Overtaking: (you are passing or being passed by another vessel)

In the following illustration, your boat is in the center. You should give the right-of-way to any vessels shown in white area (you are the Give-Way vessel). Any vessels in the shaded area must yield to you (they are the Give-Way vessels). Both you and the meeting vessel must alter course to avoid each other.

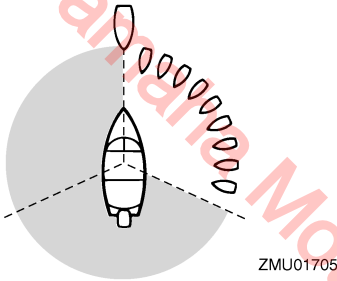

Meeting

If you are meeting another power vessel head on, and are close enough to run the risk of collision, neither of you has the right-of-way. Both of you should alter course to avoid an accident. You should keep the other vessel on your port (left) side. This rule doesn't apply if both of you will clear one another if you continue on your set course and speed.

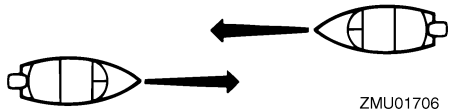
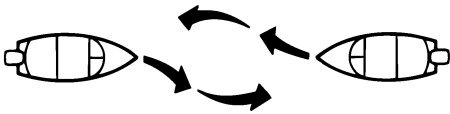

Crossing

When two power driven vessels are crossing each other's path close enough to run the risk of collision, the vessel which has the other on the starboard (right) side must keep out of the way of the other. If the other vessel is on your right, you must keep out of its way; you are the Give-Way vessel. If the other vessel is on your port (left) side, remember that you should maintain course and direction, provided the other vessel gives you the right-of-way as it should.

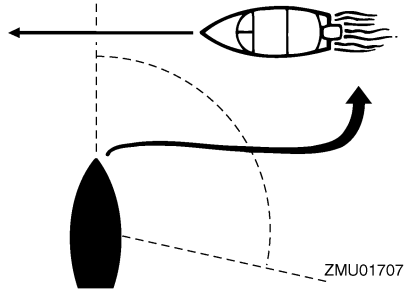

Overtaking

If you are passing another vessel, you are the "Give-Way" vessel. This means that the other vessel is expected to maintain its course and speed. You must stay out of its way until you are clear of it. Likewise, if another vessel is passing you, you should maintain your speed and direction so that the other vessel can steer itself around you.

EMU25532

Other special situations

There are three other rules you should be aware of when driving your boat around other vessels.

Narrow channels and bends

When navigating in narrow channels, you should keep to the right when it is safe and practical to do so. If the operator of a power-driven vessel is preparing to go around a bend that may obstruct the view of other wa-

ter vessels, the operator should sound a prolonged blast on the whistle (4 to 6 seconds). If another vessel is around the bend, it too should sound the whistle. Even if no reply is heard, however, the vessel should still proceed around the bend with caution. If you navigate such waters with your boat, you will need to carry a portable air horn, available from local marine supply stores.

Fishing vessel right-of-way

All vessels that are fishing with nets, lines or trawls are considered to be “fishing vessels” under the International Rules. Vessels with trolling lines are not considered fishing vessels. Fishing vessels have the right-of-way regardless of position. Fishing vessels cannot, however, impede the passage of other vessels in narrow channels.

Sailing vessel right-of-way

Sailing vessels should normally be given the right-of-way. The exceptions to this are:

1. When the sailing vessel is overtaking the power-driven vessel, the power-driven vessel has the right-of-way.
2. Sailing vessels should keep clear of any fishing vessel.
3. In a narrow channel, a sailing vessel should not hamper the safe passage of a power-driven vessel that can navigate only in such a channel.

Reading buoys and other markers

The waters of the United States are marked for safe navigation by the lateral system of buoyage. Simply put, buoys and markers have an arrangement of shapes, colors, numbers and lights to show which side of the buoy a boater should pass on when navigating in a particular direction. The markings on these buoys are oriented from the perspective of being entered from seaward (the boater is going towards the port). This means that

red buoys are passed on the starboard (right) side when proceeding from open water into port, and black buoys are to port (left) side. When navigating out of port, your position with respect to the buoys should be reversed; red buoys should be to port and black buoys to starboard.

Many bodies of water used by boaters are entirely within the boundaries of a particular state. The Uniform State Waterway Marking System has been devised for these waters. This system uses buoys and signs with distinctive shapes and colors to show regulatory or advisory information. These markers are white with black letters and orange boarders. They signify speed zones, restricted areas, danger areas, and general information.

Remember, markings may vary by geographic location. Always consult local boating authorities before driving your boat in unfamiliar waters.

Safety information

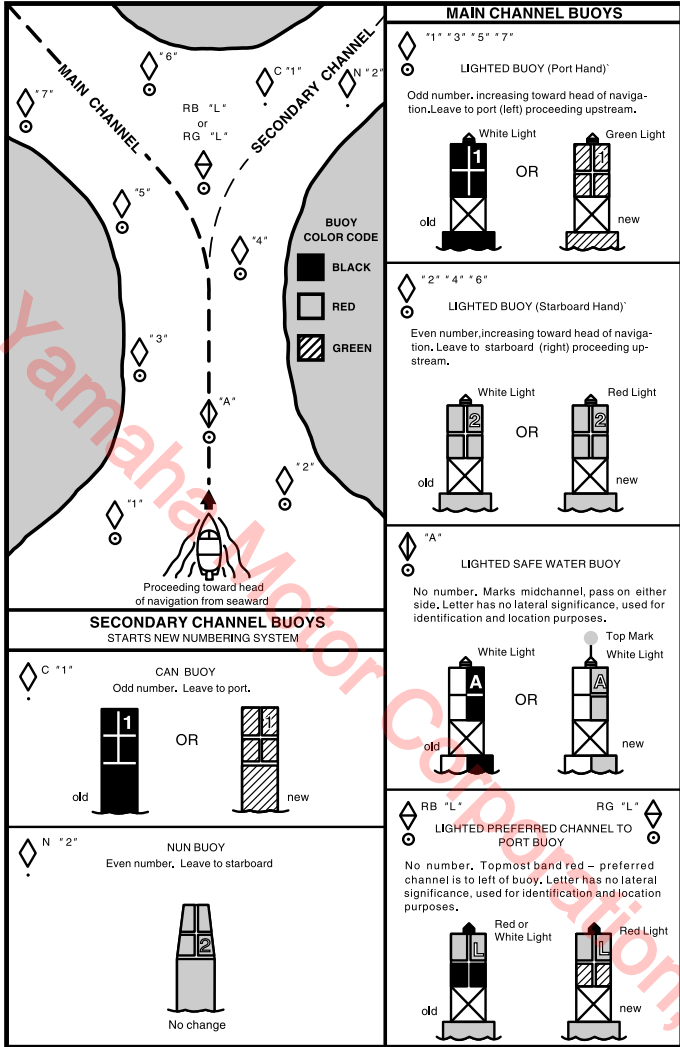

ZMU01708

EMU25172

Identification numbers record

EMU25185

Outboard motor serial number

The outboard motor serial number is stamped on the label attached to the port side of the clamp bracket.

Record your outboard motor serial number in the spaces provided to assist you in ordering spare parts from your Yamaha dealer or for reference in case your outboard motor is stolen.



ZMU01693

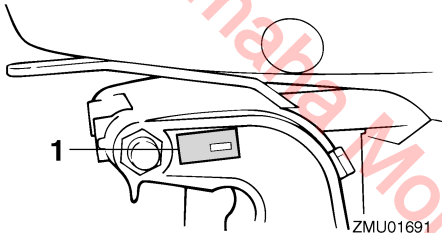

ZMU01691

1. Outboard motor serial number location

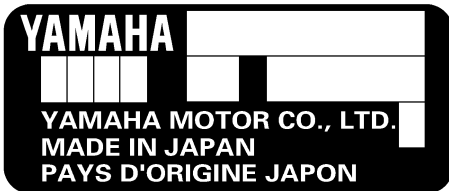

ZMU01692

EMU25192

Key number

If a main key switch is equipped with the motor, the key identification number is stamped on your key as shown in the illustration. Record this number in the space provided for reference in case you need a new key.

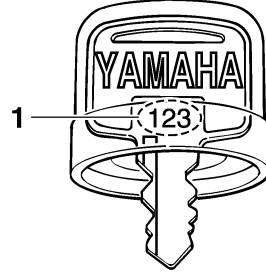

ZMU01694

1. Key number

EMU25215

C-Tick label

Engines affixed with this label conform to certain portion(s) of the Australian Radio Communications Act.

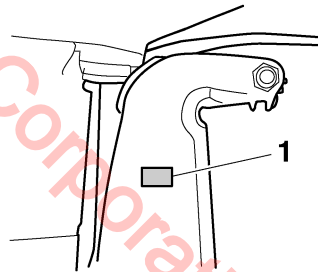

ZMU04259

1. C-Tick label location



ZMU01697

General information

EMU33524

Read manuals and labels

Before operating or working on this outboard motor:

- Read this manual.
 - Read any manuals supplied with the boat.
 - Read all labels on the outboard motor and the boat.
- If you need any additional information, contact your Yamaha dealer.

EMU33834

Warning labels

If these labels are damaged or missing, contact your Yamaha dealer for replacements.

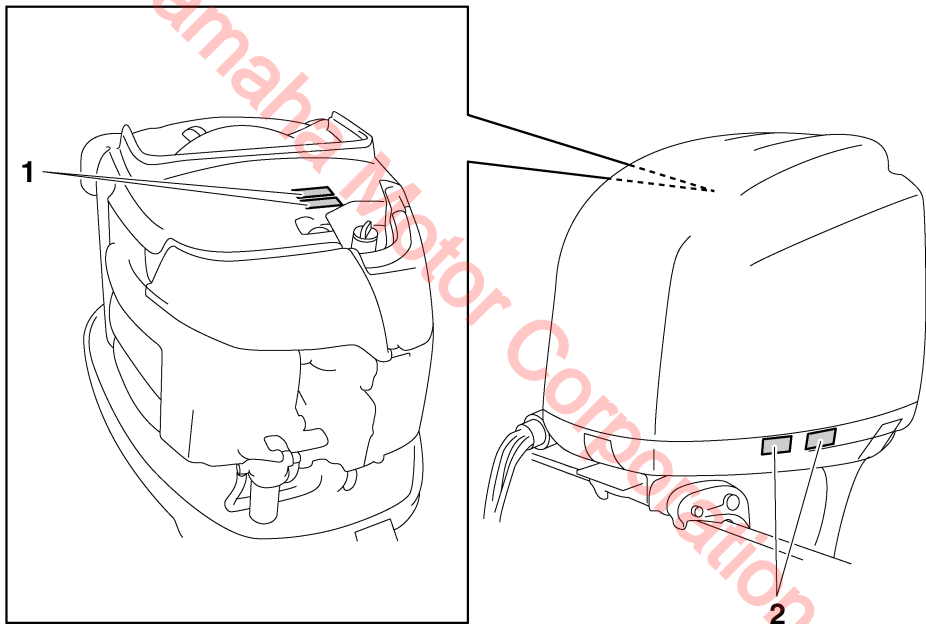

ZMU07680

1



2



EMU34652

Contents of labels

The above warning labels mean as follows.

1

EWM01682

⚠ WARNING

- Keep hands, hair, and clothing away from rotating parts while the engine is running.
- Do not touch or remove electrical parts when starting or during operation.

2

EWM01672

⚠ WARNING

- Read Owner's Manuals and labels.
- Wear an approved personal flotation device (PFD).

ZMU06191

- Attach engine shut-off cord (lanyard) to your PFD, arm, or leg so the engine stops if you accidentally leave the helm, which could prevent a runaway boat.

EMU35133

Symbols

The following symbols mean as follows.

Notice/Warning



ZMU05696

General information

Read Owner's Manual



ZMU05664

Hazard caused by continuous rotation



ZMU05665

Electrical hazard

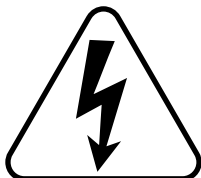

ZMU05666

Specifications and requirements

EMU40501

Specifications

TIP:

“(SUS)” indicates that the specification is for the outboard motor when it is equipped with a stainless steel propeller.

EMU2821U

Dimension and weight:

Overall length:

868 mm (34.2 in)

Overall width:

634 mm (25.0 in)

Overall height X:

1829 mm (72.0 in)

Motor transom height X:

643 mm (25.3 in)

Dry weight (SUS) X:

283 kg (624 lb)

Performance:

Full throttle operating range:

5000–6000 r/min

Rated power:

F200A 147.1 kW (200 HP)

F225A 165.5 kW (225 HP)

F250A 183.9 kW (250 HP)

LF200A 147.1 kW (200 HP)

LF250A 183.9 kW (250 HP)

Idle speed (in neutral):

600–700 r/min

Power unit:

Type:

4-stroke DOHC V6 24 valves

Total displacement:

3352 cm³ (204.5 c.i.)

Bore × stroke:

94.0 × 80.5 mm (3.70 × 3.17 in)

Ignition system:

TCI

Spark plug (NGK):

LFR6A-11

Spark plug gap:

1.0–1.1 mm (0.039–0.043 in)

Steering system:

Remote steering

Starting system:

Electric starter

Starting carburetion system:

Fuel injection

Valve clearance IN (cold engine):

0.17–0.24 mm (0.0067–0.0094 in)

Valve clearance EX (cold engine):

0.31–0.38 mm (0.0122–0.0150 in)

Cold cranking amps (CCA/SAE):

512–1150 A

Marine cranking amps (MCA/ABYC):

675–1370 A

Min. reserve capacity (RC/SAE):

124 minutes

Cold cranking amps (CCA/EN):

510–1080 A

Min. rated capacity (20HR/IEC):

80 Ah

Maximum generator output:

44 A

Lower unit:

Gear shift positions:

Forward-neutral-reverse

Gear ratio:

2.00(30/15)

Trim and tilt system:

Power trim and tilt

Propeller mark:

F200A M/T

F225A M/T

F250A M/T

LF200A ML/TL

LF250A ML/TL

Specifications and requirements

Fuel and oil:

Recommended fuel:

- F200A Regular unleaded gasoline
- F225A Regular unleaded gasoline
- F250A Mid-grade unleaded gasoline
(For North America), Premium unleaded gasoline
- LF200A Regular unleaded gasoline
- LF250A Mid-grade unleaded gasoline
(For North America), Premium unleaded gasoline

Min. pump octane number (PON):

- F200A 86
- F225A 86
- F250A 89
- LF200A 86
- LF250A 89

Min. research octane number (RON):

- F200A 90
- F225A 90
- F250A 94
- LF200A 90
- LF250A 94

Recommended engine oil:

YAMALUBE 4M FC-W or 4-stroke outboard motor oil

Recommended engine oil grade 1:

SAE 10W-30/10W-40/5W-30
API SE/SF/SG/SH/SJ/SL

Engine oil quantity (without oil filter replacement):

4.5 L (4.76 US qt, 3.96 Imp.qt)

Engine oil quantity (with oil filter replacement):

4.7 L (4.97 US qt, 4.14 Imp.qt)

Lubrication system:

Wet sump

Recommended gear oil:

Yamalube Marine Gearcase Lube or Hypoid gear oil

Recommended gear oil grade:

SAE 90 API GL-4

Gear oil quantity:

- F200A 1.150 L (1.216 US qt, 1.012 Imp.qt)
- F225A 1.150 L (1.216 US qt, 1.012 Imp.qt)
- F250A 0.920 L (0.972 US qt, 0.810 Imp.qt)
- LF200A 1.000 L (1.057 US qt, 0.880 Imp.qt)
- LF250A 0.800 L (0.846 US qt, 0.704 Imp.qt)

Tightening torque:

Spark plug:

25 Nm (2.55 kgf-m, 18.4 ft-lb)

Propeller nut:

54 Nm (5.51 kgf-m, 39.8 ft-lb)

Engine oil drain bolt:

27 Nm (2.75 kgf-m, 19.9 ft-lb)

Engine oil filter:

18 Nm (1.84 kgf-m, 13.3 ft-lb)

EMU33555

Installation requirements

EMU33565

Boat horsepower rating

EWM01561



WARNING

Overpowering a boat can cause severe instability.

Before installing the outboard motor(s), confirm that the total horsepower of your outboard motor(s) does not exceed the boat's maximum horsepower rating. See the boat's capacity plate or contact the manufacturer.

Specifications and requirements

EMU40491

Mounting outboard motor

EWM02501

WARNING

- **Improper mounting of the outboard motor could result in hazardous conditions such as poor handling, loss of control, or fire hazards.**
- **Because the outboard motor is very heavy, special equipment and training is required to mount it safely.**

Your dealer or other person experienced in proper rigging should mount the outboard motor using correct equipment and complete rigging instructions. For further information, see page 46.

EMU33582

Remote control requirements

EWM01581

WARNING

- **If the engine starts in gear, the boat can move suddenly and unexpectedly, possibly causing a collision or throwing passengers overboard.**
- **If the engine ever starts in gear, the start-in-gear protection device is not working correctly and you should discontinue using the outboard. Contact your Yamaha dealer.**

The remote control unit must be equipped with a start-in-gear protection device(s). This device prevents the engine from starting unless it is in neutral.

EMU25695

Battery requirements

EMU44721

Specifications of Battery

Use a fully charged battery that meets the following specifications. The engine cannot be started if battery voltage is too low.

For North America

Cold cranking amps (CCA/SAE):

512–1150 A

Marine cranking amps (MCA/ABYC):

675–1370 A

Min. reserve capacity (RC/SAE):

124 minutes

For Oceania

Cold cranking amps (CCA/EN):

510–1080 A

Min. rated capacity (20HR/IEC):

80 Ah

ECM01063

NOTICE

- **Do not use a battery that does not meet the specified capacity. If a battery that does not meet specifications is used, the electric system could perform poorly or be overloaded, causing electric system damage.**
- **Do not use a battery which exceeds the maximum CCA rating. If the batteries are used in parallel circuit, use new batteries of the same type and make sure that the total battery rating never exceed the maximum CCA rating.**

EMU36291

Mounting battery

Mount the battery holder securely in a dry, well-ventilated, vibration-free location in the boat. **WARNING! Do not put flammable items, or loose heavy or metal objects in the same compartment as the battery. Fire, explosion or sparks could result.**

[EWM01821]

Specifications and requirements

EMU36301

Multiple batteries

To connect multiple batteries, such as for multiple engine configurations or for an accessory battery, consult your Yamaha dealer about battery selection and correct wiring.

EMU41602

Propeller selection

Next to selecting an outboard motor, selecting the right propeller is one of the most important purchasing decisions a boater can make. The type, size, and design of your propeller have a direct impact on acceleration, top speed, fuel economy, and even engine life. Yamaha designs and manufactures propellers for every Yamaha outboard motor and every application.

Your Yamaha dealer can help you select the right propeller for your boating needs. Select a propeller that will allow the engine to reach the middle or upper half of the operating range at full throttle with the maximum boatload. Generally, select a larger pitch propeller for a smaller operating load and a smaller pitch propeller for a heavier load. If you carry loads that vary widely, select the propeller that lets the engine run in the proper range for your maximum load but remember that you may need to reduce your throttle setting to stay within the recommended engine speed range when carrying lighter loads.

Yamaha recommends to use a propeller suitable for the "Shift Dampener System (SDS)". For further information, consult your Yamaha dealer.

To check the propeller, see page 80.

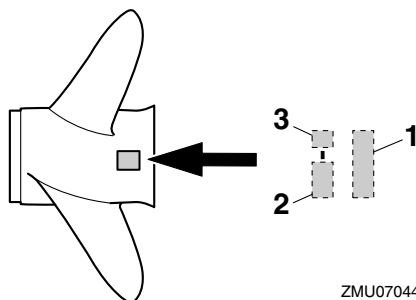

ZMU07044

1. Propeller diameter in inches
2. Propeller pitch in inches
3. Type of propeller (propeller mark)

EMU36312

Counter rotation models

Standard outboard motors rotate clockwise. Counter rotation models rotate counterclockwise and are typically used in multiple motor setups.

On counter rotation models, be sure to use a propeller intended for counterclockwise rotation. These propellers are identified with the letter "L" after the size indication on the propeller. **WARNING! Never use a standard propeller with a counter rotation motor, or a counter rotation propeller with a standard motor. Otherwise the boat could go in the direction opposite of that expected (for example, reverse instead of forward), which could lead to an accident.** [EWM01811]

For instructions on propeller removal and installation, see page 80 and 81.

EMU25771

Start-in-gear protection

Yamaha outboard motors or Yamaha-approved remote control units are equipped with start-in-gear protection device(s). This feature permits the engine to be started only when it is in neutral. Always select neutral before starting the engine.

Specifications and requirements

EMU41953

Engine oil requirements

Select an oil grade according to the average temperatures in the area where the outboard motor will be used.

Recommended engine oil:

YAMALUBE 4M FC-W or 4-stroke outboard motor oil

Recommended engine oil grade 1:

SAE 10W-30/10W-40/5W-30
API SE/SF/SG/SH/SJ/SL

Recommended engine oil grade 2:

SAE 15W-40/20W-40/20W-50
API SH/SJ/SL

Engine oil quantity (without oil filter replacement):

4.5 L (4.76 US qt, 3.96 Imp.qt)

Engine oil quantity (with oil filter replacement):

4.7 L (4.97 US qt, 4.14 Imp.qt)

If oil grades listed under Recommended engine oil grade 1 are not available, select an alternative oil grade listed under Recommended engine oil grade 2.

Recommended engine oil grade 1

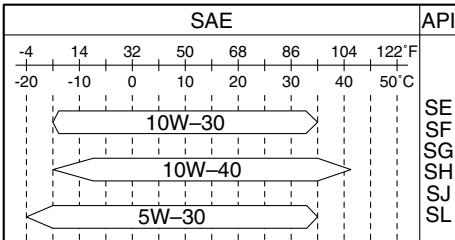

ZMU06854

Recommended engine oil grade 2

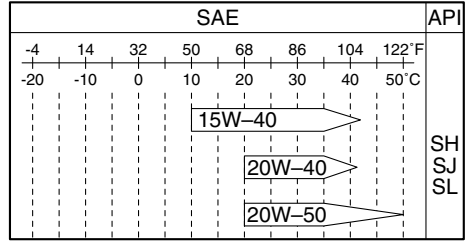

ZMU06855

EMU36361

Fuel requirements

EMU44790

Gasoline

Use a good quality gasoline that meets the minimum octane requirement. If knocking or pinging occurs, use a different brand of gasoline or premium unleaded fuel. Yamaha recommends that you use alcohol-free gasoline (see Gasoline with Ethanol) whenever possible.

The use of a poor quality gasoline may result in starting and running problems. If you encounter drivability problems, which you suspect could be related to the fuel you are using, we recommend that you switch to a recognized high quality brand of gasoline, such as a gasoline that is advertised as Top Tier Detergent Gasoline. (North America only) Failure to comply with these recommendations may also result in unscheduled maintenance, fuel system damage, and internal engine damage.

Specifications and requirements

For North America

Recommended fuel:

F200A Regular unleaded gasoline
F225A Regular unleaded gasoline
F250A Mid-grade unleaded gasoline
LF200A Regular unleaded gasoline
LF250A Mid-grade unleaded gasoline

Min. pump octane number (PON):

F200A 86
F225A 86
F250A 89
LF200A 86
LF250A 89

For Oceania

Recommended fuel:

F200A Regular unleaded gasoline
F225A Regular unleaded gasoline
F250A Premium unleaded gasoline
LF200A Regular unleaded gasoline
LF250A Premium unleaded gasoline

Min. research octane number (RON):

F200A 90
F225A 90
F250A 94
LF200A 90
LF250A 94

ECM01982

NOTICE

- **Do not use leaded gasoline. Leaded gasoline can seriously damage the engine.**
- **Avoid getting water and contaminants in the fuel tank. Contaminated fuel can cause poor performance or engine damage. Use only fresh gasoline that has been stored in clean containers.**

Gasoline with Ethanol

Two types of gasoline are commonly available in the U.S.A., Canada, Australia and New Zealand for use in automobiles and boats: conventional gasoline without Ethanol and gasoline with Ethanol, which is typically

referred to as E10 gasoline. According to federal regulations, E10 gasoline may contain up to 10% Ethanol.

A high quality gasoline without Ethanol is the preferred fuel for your Yamaha outboard motor. However, if gasoline with Ethanol is the only fuel available in your area, your Yamaha outboard motor is calibrated to run properly on fresh E10 gasoline that meets the minimum octane requirement specified for this model.

ECM02402

NOTICE

Never use a gasoline for your outboard motor that contains more than 10% Ethanol, such as E15 which contains 15% Ethanol, or E85 which contains 85% Ethanol, or gasoline containing any amount of Methanol. These fuels can cause starting and running problems, as well as serious fuel system and internal engine damage.

Gasoline containing ethanol has several properties that may cause boat fuel system problems.

- Ethanol is a strong solvent (cleaning agent) that can clean gum and varnish deposits from a boat's fuel system, particularly in older boats, as well as tanks and pipes used in gasoline distribution. These released deposits contaminate the fuel and can cause problems, such as clogged fuel filters, carburetors, or fuel injectors, which could result in engine damage.
- Ethanol may dissolve resins used in the construction of fiberglass fuel tanks. The dissolved resins contaminate the fuel and can cause problems, such as clogged fuel filters, carburetors, or fuel injectors, which could result in engine damage.

Specifications and requirements

- Ethanol is hygroscopic (has a strong attraction to water). Therefore, any water that inadvertently enters the fuel system, including moisture that is absorbed from the air, will mix with the ethanol in the gasoline. If the amount of water is excessive, the ethanol and water mixture will separate from the gasoline in a layer at the bottom of the fuel tank. This ethanol and water mixture is very corrosive to aluminum fuel tanks and fuel system components.
- The usable life span of E10 gasoline may be shorter than the normal length of off-season boat storage, causing starting and running problems related to stale fuel.

For more information on using fuel containing ethanol, visit: <http://www.yamaha-motor.com>

Gasoline Filtration

Yamaha outboard motors are equipped with internal fuel filters. However, excessive water or debris entering your engine's fuel system could prematurely clog the internal filters, causing starting and running problems, fuel system damage, and internal engine damage. Therefore, it is recommended that an external 10-micron water-separating fuel filter be installed on your boat and serviced frequently. Consult your authorized Yamaha dealer for a 10-micron filter that meets your engine's requirements.

EMU41342

Gasoline Additives

Gasoline blends change to meet automobile emission regulations and economic conditions. Additives, added by gasoline distributors, necessary for proper automobile engine operation and durability, may not be sufficient for typical boat applications. Intake valve and combustion chamber deposits may accumulate in boat engines more rapidly than encountered in automotive use. In addition,

gasoline used for boating will typically age longer between refills than gasoline used in automobiles, resulting in stale and unusable gasoline that may cause starting and running problems, fuel system damage, and internal engine damage.

Yamaha recommends the use of two Yamalube gasoline additives to reduce internal deposits and extend the storage life of gasoline. Continuous use of Yamalube Ring Free Fuel Additive Plus reduces harmful internal deposits. Yamalube Fuel Stabilizer & Conditioner Plus added to fresh gasoline will help protect the fuel system from varnishing while helping to keep the gasoline's octane level from decreasing excessively during storage. Other additives may also be available on the market that may have varying degrees of effectiveness. Consult your Yamaha dealer concerning what may work best for the locally available gasoline and environmental conditions.

EMU41351

Anti-fouling paint

A clean hull is required to maintain your boat's performance. Boats moored in the water should be protected from marine growth (barnacles, mussels, and marine plants). If approved by regulations for your area, the bottom of the hull can be coated with an anti-fouling paint to inhibit marine growth.

Anti-fouling paints specifically formulated for use on aluminum may be applied to the outboard motor. The original Yamaha paint surface may be scuffed lightly before applying anti-fouling paint, but do not remove the original paint. Removal of the original paint will increase the rate of corrosion.

Specifications and requirements

ECM02411

NOTICE

Anti-fouling paint for fiberglass and wood may contain materials, such as copper, graphite, and tin, that can cause corrosion if applied to aluminum boats and outboard motor components. Never apply these types of paint to your outboard motor because rapid corrosion damage could occur.

Sacrificial anodes are attached to the outboard motor to provide corrosion protection and must never be painted.

ECM02421

NOTICE

Painted sacrificial anodes will not provide corrosion protection.

EMU40302

Outboard motor disposal requirements

Never illegally discard (dump) the outboard motor. Yamaha recommends consulting the dealer about discarding the outboard motor.

EMU36353

Emergency equipment

Keep the following items onboard in case there is trouble with the outboard motor.

- A tool kit with assorted screwdrivers, pliers, wrenches (including metric sizes), and electrical tape.
- Waterproof flashlight with extra batteries.
- An extra engine shut-off cord (lanyard) with clip.
- Spare parts, such as an extra set of spark plugs.

Consult your Yamaha dealer for details.

EMU25223

Emission control information

EMU25232

This engine conforms to U.S. Environmental Protection Agency (EPA) regulations for marine SI engines. See the label affixed to your engine for details.

EMU31562

Approval label of emission control certificate

This label is attached to the bottom cowling. New Technology; (4-stroke) MFI

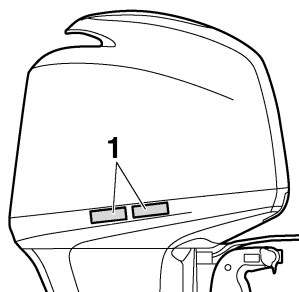

ZMU05757

1. Approval label location

EMISSION CONTROL INFORMATION		MFI
THIS ENGINE CONFORMS TO CALIFORNIA AND U.S. EPA EXHAUST REGULATIONS FOR SI MARINE ENGINES. REFER TO THE OWNER'S MANUAL FOR MAINTENANCE SPECIFICATIONS AND ADJUSTMENTS. MEETS U.S. EPA EVAP STANDARDS USING CERTIFIED COMPONENTS.		
FAMILY:	FELs(HC+NOx/CO):	g/kW-hr MAX POWER: kW
DISPLACEMENT:	liters	IDLE SPEED: rpm IN NEUTRAL
SPARK PLUG:	SPARK PLUG GAP (mm):	
FUEL: GASOLINE	VALVE LASH (mm) IN:	EX:
YAMAHA MOTOR CO.,LTD.		

INFORMATION ANTIPOLLUTION		MFI
CE MOTEUR EST CONFORME AUX NORMES D'ÉMISSIONS CALIFORNIE ET DE LA CALIFORNIE POUR MOTEURS MARINS À ÉTINCELLE. POUR LES SPÉCIFICATIONS ET LES RÉGLAGES À EFFECTUER, CONSULTEZ LE MANUEL DU PROPRIÉTAIRE. INSTALLEZ AVEC LES COMPOSANTS HOMOLOGUÉS. IL SATISFAIT AUX NORMES EVAP EPA DES É.-U.		
FAMILLE:	FELs(HC+NOx/CO):	g/kW-hr PUISS. MAX: kW
CYLINDRÉE:	litre	tr/min AU POINT MORT
BOUGIE:	BOUGIE-ÉCARTEMENT (mm):	
CARBURANT:	ESSENCE	JEU DE SOUPAPES (mm) ADM: ECH:
YAMAHA MOTOR CO.,LTD.		

ZMU06895

EMU39202

Manufactured date label

This label is attached to the clamp bracket.

Specifications and requirements

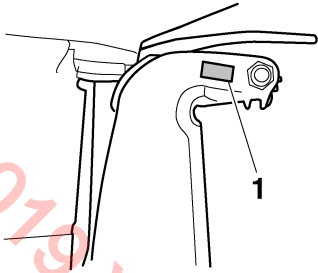

ZMU01700

1. Manufactured date label location

EMU40331

One Star—Low Emission

The one-star label identifies engines that meet the Air Resources Board's Personal Watercraft and Outboard marine engine 2001 exhaust emission standards. Engines meeting these standards have 75% lower emissions than conventional carbureted two-stroke engines. These engines are equivalent to the U.S. EPA's 2006 standards for marine engines.

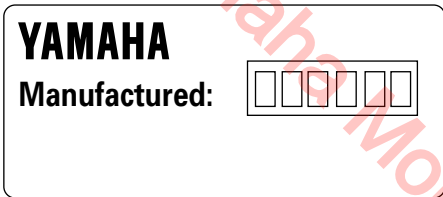

ZMU04346



ZMU01702

EMU25275

Star labels

Your outboard motor is labeled with a California Air Resources Board (CARB) star label. See below for a description of your particular label.

EMU40341

Two Stars—Very Low Emission

The two-star label identifies engines that meet the Air Resources Board's Personal Watercraft and Outboard marine engine 2004 exhaust emission standards. Engines meeting these standards have 20% lower emissions than One Star-Low-Emission engines.

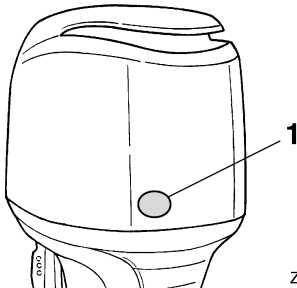

ZMU03981

1. Star labels location



ZMU01703

Specifications and requirements

EMU40351

Three Stars—Ultra Low Emission

The three-star label identifies engines that meet the Air Resources Board's Personal Watercraft and Outboard marine engine 2008 exhaust emission standards or the Sterndrive and Inboard marine engine 2003-2008 exhaust emission standards. Engines meeting these standards have 65% lower emissions than One Star-Low-Emission engines.



ZMU01704

EMU33862

Four Stars—Super Ultra Low Emission

The four-star label identifies engines that meet the Air Resources Board's Sterndrive and Inboard marine engine 2009 exhaust emission standards. Personal Watercraft and Outboard marine engines may also comply with these standards. Engines meeting these standards have 90% lower emissions than One Star-Low-Emission engines.



ZMU05663

EMU2579Z

Components diagram

TIP:

* May not be exactly as shown; also may not be included as standard equipment on all models (order from dealer).

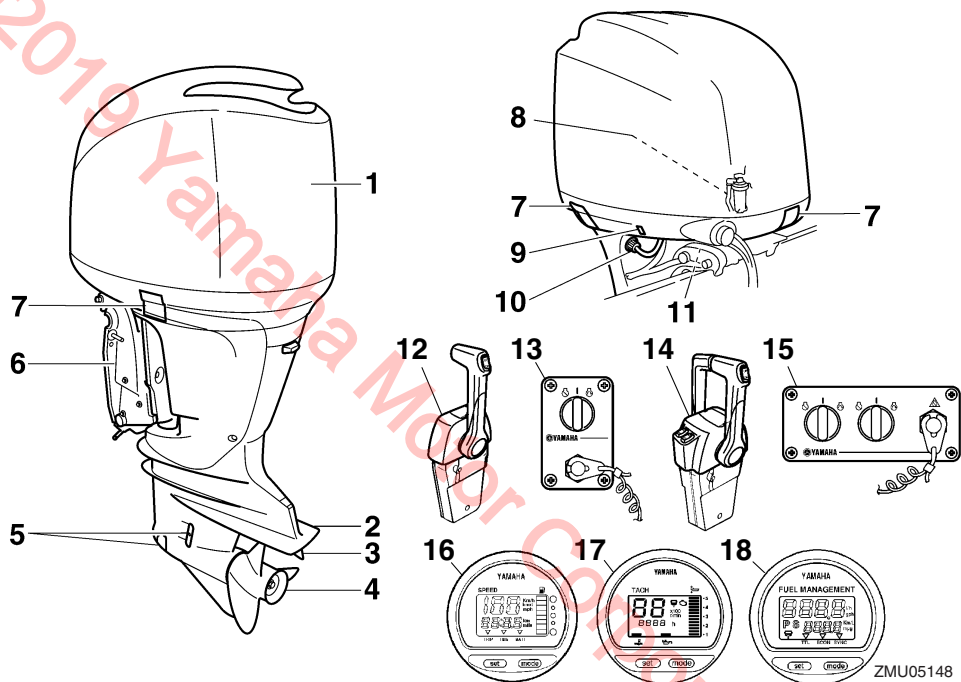

1. Top cowling
2. Anti-cavitation plate
3. Trim tab (anode)
4. Propeller*
5. Cooling water inlet*
6. Clamp bracket
7. Cowling lock lever(s)
8. Water separator
9. Power trim and tilt switch
10. Flushing device
11. Tilt support lever
12. Remote control box (binnacle mount type)*
13. Switch panel (for use with binnacle type)*
14. Remote control box (binnacle mount type)*
15. Switch panel (for use with binnacle type)*

16. Digital speedometer*
17. Digital tachometer*
18. Fuel management meter*

ZMU05148

Components

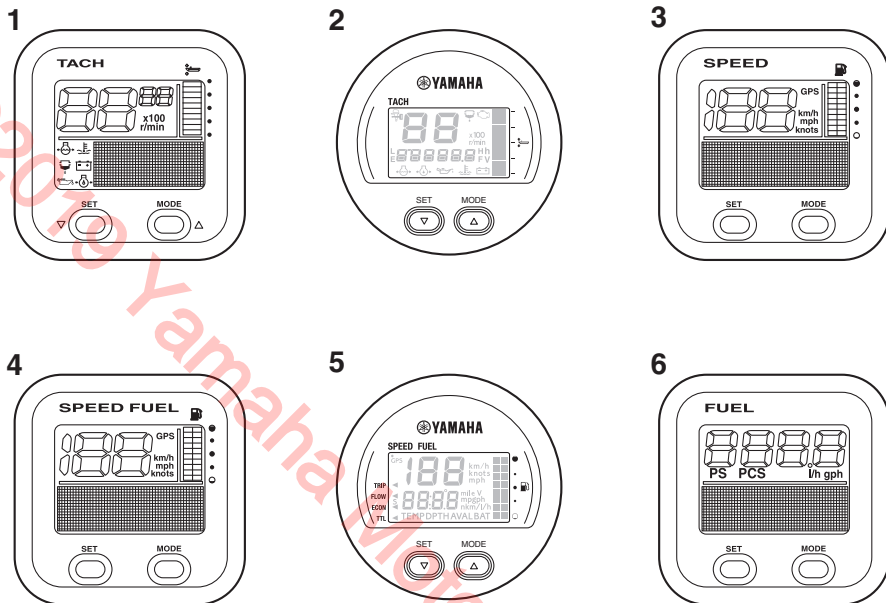

ZMU05429

1. Tachometer unit (Square type)*
2. Tachometer unit (Round type)*
3. Speedometer unit (Square type)*
4. Speed & fuel meter unit (Square type)*
5. Speed & fuel meter unit (Round type)*
6. Fuel management meter unit (Square type)*

EMU26182

Remote control box

The remote control lever actuates both the shifter and the throttle. The electrical switches are mounted on the remote control box.

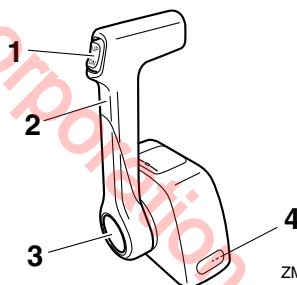

ZMU04572

1. Power trim and tilt switch
2. Remote control lever
3. Free accelerator
4. Throttle friction adjuster

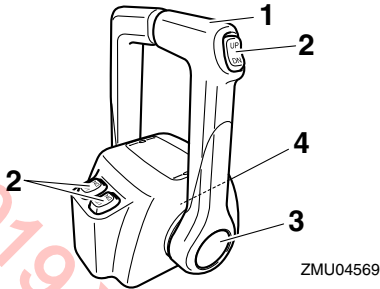

1. Remote control lever
2. Power trim and tilt switch
3. Free accelerator
4. Throttle friction adjuster

EMU26191

Remote control lever

Moving the lever forward from the neutral position engages forward gear. Pulling the lever back from neutral engages reverse. The engine will continue to run at idle until the lever is moved about 35° (a detent can be felt). Moving the lever farther opens the throttle, and the engine will begin to accelerate.

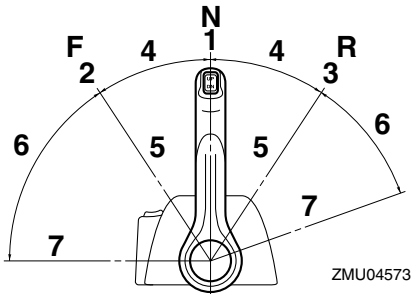

1. Neutral "N"
2. Forward "F"
3. Reverse "R"
4. Shift
5. Fully closed
6. Throttle
7. Fully open

EMU26234

Free accelerator

To open the throttle without shifting into either forward or reverse, push the free accelerator button and move the remote control lever.

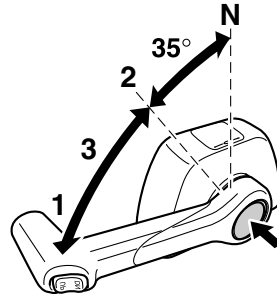

1. Fully open
2. Fully closed
3. Free accelerator

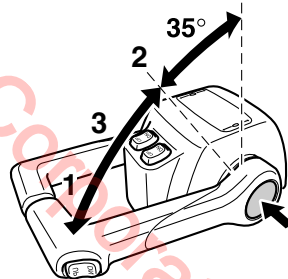

1. Fully open
2. Fully closed
3. Free accelerator

TIP:

- The free accelerator button can only be pushed when the remote control lever is in the neutral position.
- After the button is pushed, the throttle begins to open after the remote control lever is moved at least 35°.
- After using the free accelerator, return the remote control lever to the neutral position. The free accelerator button will return auto-

Components

matically to its set position. The remote control will then engage forward and reverse normally.

EMU25977

Throttle friction adjuster

A friction device provides adjustable resistance to movement of the throttle grip or the remote control lever, and can be set according to operator preference.

To increase resistance, turn the adjuster clockwise. To decrease resistance, turn the adjuster counterclockwise. **WARNING! Do not overtighten the friction adjuster. If there is too much resistance, it could be difficult to move the remote control lever or throttle grip, which could result in an accident.** [EWM00033]

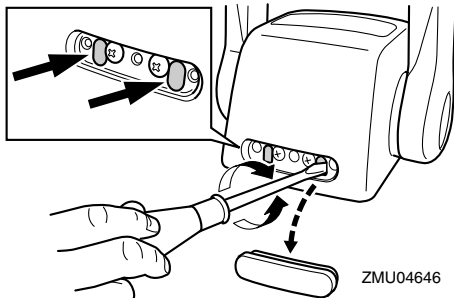
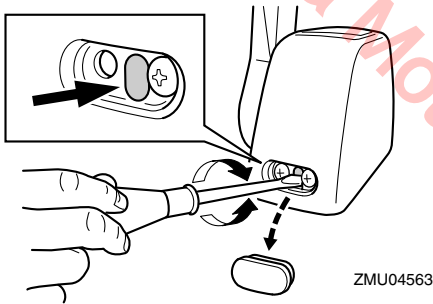

When constant speed is desired, tighten the adjuster to maintain the desired throttle setting.

EMU25996

Engine shut-off cord (lanyard) and clip

The clip must be attached to the engine shut-off switch for the engine to run. The cord should be attached to a secure place on the operator's clothing, or arm or leg. Should the operator fall overboard or leave the helm, the cord will pull out the clip, stopping ignition to the engine. This will prevent the boat from running away under power. **WARNING! Attach the engine shut-off cord to a secure place on your clothing, or your arm or leg while operating. Do not attach the cord to clothing that could tear loose. Do not route the cord where it could become entangled, preventing it from functioning. Avoid accidentally pulling the cord during normal operation. Loss of engine power means the loss of most steering control. Also, without engine power, the boat could slow rapidly. This could cause people and objects in the boat to be thrown forward.** [EWM00123]

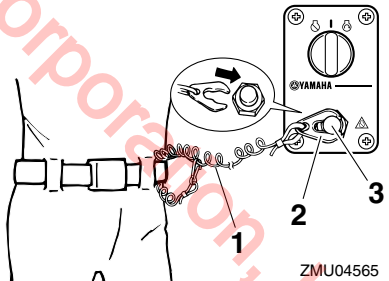

1. Engine shut-off cord (lanyard)
2. Clip
3. Engine shut-off switch

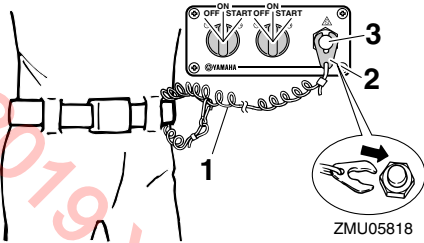

ZMU05818

1. Engine shut-off cord (lanyard)
2. Clip
3. Engine shut-off switch

EMU26092

Main switch

The main switch controls the ignition system; its operation is described below.

● “OFF” (off)

With the main switch in the “OFF” (off) position, the electrical circuits are off, and the key can be removed.

● “ON” (on)

With the main switch in the “ON” (on) position, the electrical circuits are on, and the key cannot be removed.

● “START” (start)

With the main switch in the “START” (start) position, the starter motor turns to start the engine. When the key is released, it returns automatically to the “ON” (on) position.

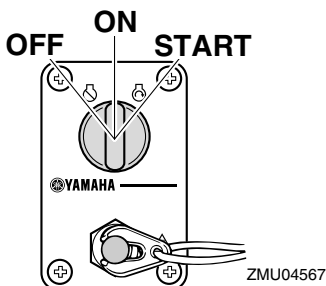

ZMU04567

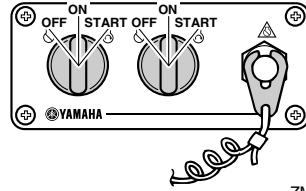

ZMU05821

EMU32054

Power trim and tilt switch on remote control

The power trim and tilt system adjusts the outboard motor angle in relation to the transom. Pushing the switch “UP” (up) trims the outboard motor up, and then tilts it up. Pushing the switch “DN” (down) tilts the outboard motor down and trims it down. When the switch is released, the outboard motor will stop in its current position. For instructions on using the power trim and tilt switch, see pages 58 and 60.

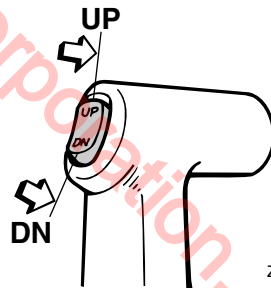

ZMU03938

EMU26156

Power trim and tilt switch on bottom cowling

The power trim and tilt switch is located on the side of the bottom cowling. Pushing the switch “UP” (up) trims the outboard motor up, and then tilts it up. Pushing the switch “DN” (down) tilts the outboard motor down and

Components

trims it down. When the switch is released, the outboard motor will stop in its current position.

For instructions on using the power trim and tilt switch, see page 60.

EWM01032

WARNING

Use the power trim and tilt switch located on the bottom cowling only when the boat is at a complete stop with the engine off. Attempting to use this switch while the boat is moving could increase the risk of falling overboard and could distract the operator, increasing the risk of collision with another boat or an obstacle.

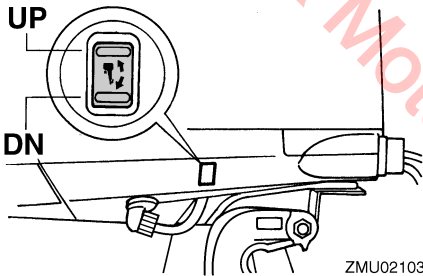

EMU26164

Power trim and tilt switches (twin binocular type)

The power trim and tilt system adjusts the outboard motor angle in relation to the transom. Pushing the switch “UP” (up) trims the outboard motor up, and then tilts it up. Pressing the switch “DN” (down) tilts the outboard motor down and trims it down. When the switch is released, the outboard motor will stop in its current position. For instructions on using the power trim and tilt switches, see pages 58 and 60.

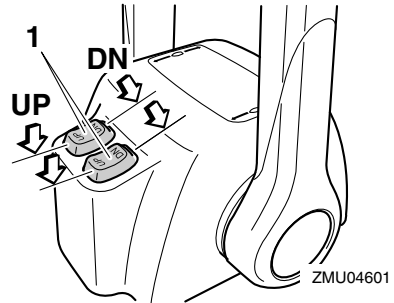

1. Power trim and tilt switch

TIP:

On the dual engine control, the switch on the remote control grip controls both outboard motors at the same time.

EMU26245

Trim tab with anode

EWM00841

WARNING

An improperly adjusted trim tab could cause difficult steering. Always test run after the trim tab has been installed or replaced to be sure steering is correct. Be sure you have tightened the bolt after adjusting the trim tab.

The trim tab should be adjusted so that the steering control can be turned to either the right or left by applying the same amount of force.

If the boat tends to veer to the left (port side), turn the trim tab rear end to the port side “A” in the figure. If the boat tends to veer to the right (starboard side), turn the trim tab end to the starboard side “B” in the figure.

ECM00841

NOTICE

The trim tab also serves as an anode to protect the engine from electrochemical corrosion. Never paint the trim tab as it will become ineffective as an anode.

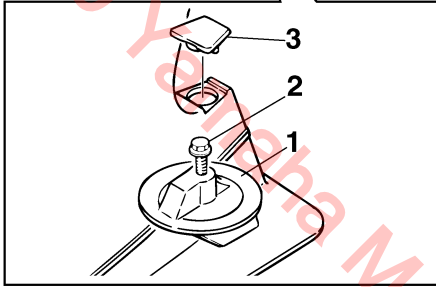
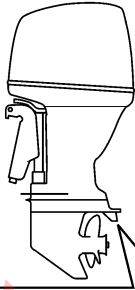

ZMU01730

1. Trim tab
2. Bolt
3. Cap

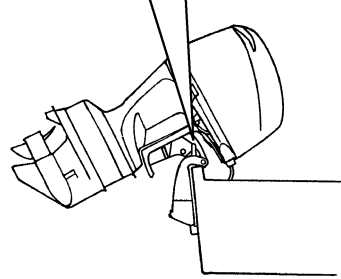
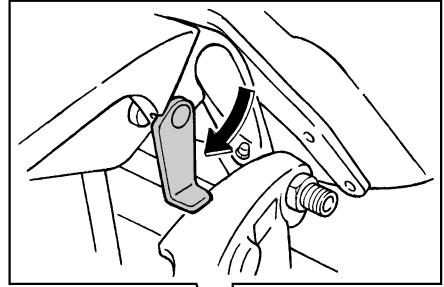

ZMU05352

ECM00661

NOTICE

Do not use the tilt support lever or knob when trailering the boat. The outboard motor could shake loose from the tilt support and fall. If the motor cannot be trailered in the normal running position, use an additional support device to secure it in the tilt position.

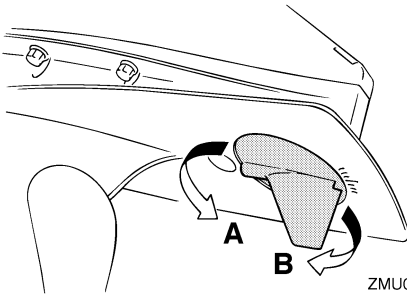

ZMU02104

Bolt tightening torque:

42 Nm (4.28 kgf-m, 31.0 ft-lb)

EMU26342

Tilt support lever for power trim and tilt model

To keep the outboard motor in the tilted up position, lock the tilt support lever to the clamp bracket.

EMU31422

Cowling lock lever (pull up type)

To remove the top cowling, pull up the cowling lock lever(s) and lift off the cowling. To install the top cowling, place it in its original position, and then move the cowling lock lever(s) downward to lock it in place.

TIP:

- When installing the cowling, check to be sure it fits properly in the rubber seal.

Components

- Be sure to check that the gap between the top cowling and the bottom cowling is even all around the cowling. If the top cowling is loose or the gap is not even, reinstall the cowling.

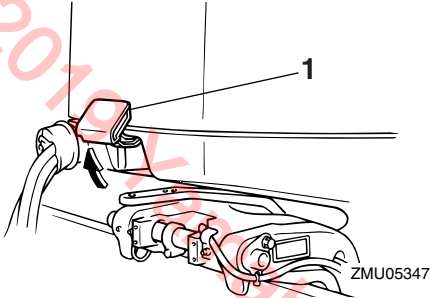

1. Cowling lock lever(s)

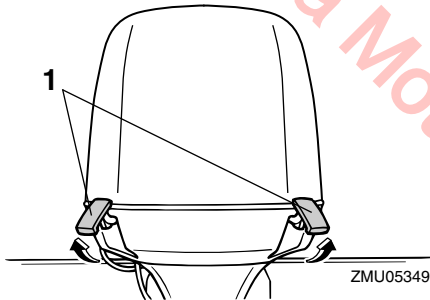

1. Cowling lock lever(s)

EMU26464

Flushing device

This device is used to clean the cooling water passages of the motor using a garden hose and tap water.

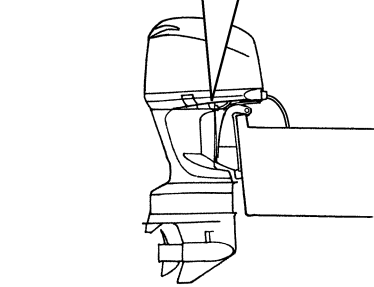
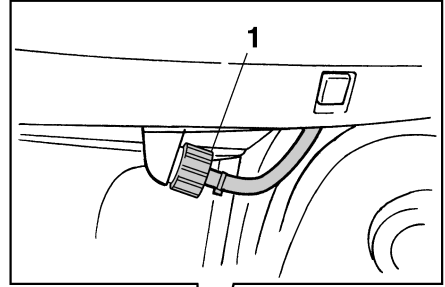

ZMU02108

1. Flushing device

TIP:

For details on usage, see page 67.

EMU33467

Fuel filter/Water separator

This engine has a combination fuel filter/water separator and associated alert system. If water separated from the fuel exceeds a specific volume, the alert device of 6Y8 Multi-function Tachometer will activate.

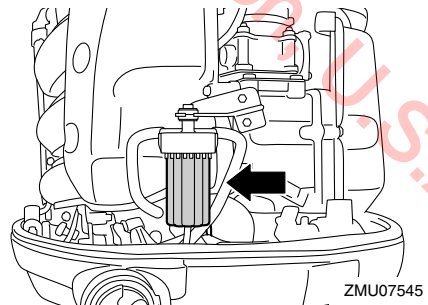

Activation of alert device

- The water separator-alert indicator of 6Y8 Multifunction Tachometer will blink.
- The buzzer will sound intermittently only when the gear shift is in neutral.
- If the alert system has activated, stop the engine and consult a Yamaha dealer immediately.

TIP:

Adding an in-line 10-micron fuel filter has been shown to greatly reduce the chance of fuel contamination problems. Consult your dealer for information about Yamaha 10-micron fuel filters if your boat does not have one.

Instruments and indicators

EMU31415

Digital tachometer

The tachometer shows the engine speed and has the following functions.

All segments of the display will light momentarily after the main switch is turned on and will return to normal thereafter.

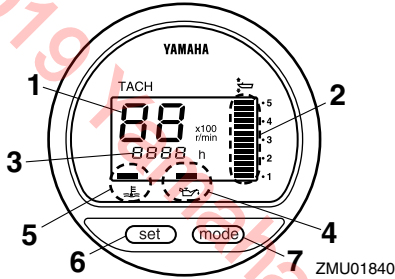

1. Tachometer
2. Trim meter
3. Hour meter
4. Low oil pressure-alert indicator
5. Overheat-alert indicator
6. Set button
7. Mode button

TIP:

The water separator-alert indicator and engine trouble-alert indicator on the digital tachometer do not operate for this engine.

EMU36051

Tachometer

The tachometer displays engine speed in hundreds of revolutions per minute (r/min). For example, if the tachometer display reads “22” then the engine speed is 2200 r/min.

EMU26622

Trim meter

This meter shows the trim angle of your outboard motor.

- Memorize the trim angles that work best for your boat under different conditions. Adjust the trim angle to the desired using the power trim and tilt switch.

- If the trim angle of your motor exceeds the trim operating range, the top segment on the trim meter display will blink.

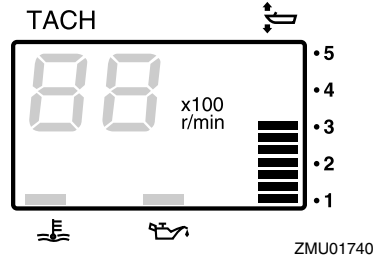

EMU26652

Hour meter

This meter shows the number of hours the engine has been run. It can be set to show the total number of hours or the number of hours for the current trip. The display can also be turned on and off.

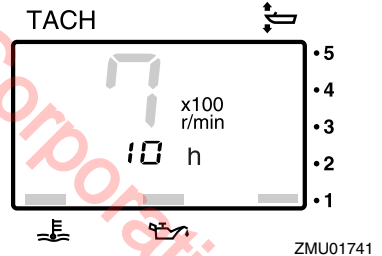

To change the display format, press the “mode” (mode) button. The display can show total hours or trip hours, or turn off.

To reset the trip hours, simultaneously press the “set” (set) and “mode” (mode) buttons for more than 1 second while the trip hours are displayed. This resets the trip counter to 0 (zero).

The total number of hours the engine has been run cannot be reset.

Instruments and indicators

EMU26525

Low oil pressure-alert indicator

If oil pressure drops too low, the alert indicator will start to blink. For further information, see page 44.

ECM00023

NOTICE

- Do not continue to run the engine if the low oil pressure-alert indicator is on and the engine oil level is lower. Serious engine damage will occur.
- The low oil pressure-alert indicator does not indicate the engine oil level. Use the oil dipstick to check the remaining oil quantity. For further information, see page 50.

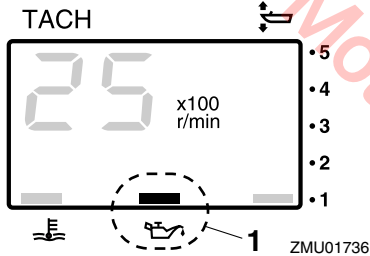

1. Low oil pressure-alert indicator

EMU26584

Overheat-alert indicator

If the engine temperature rises too high, the alert indicator will start to blink. For further information on reading the indicator, see page 44.

ECM00053

NOTICE

- Do not continue to run the engine if the overheat-alert indicator is on. Serious engine damage will occur.

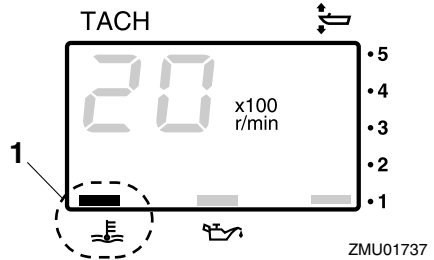

1. Overheat-alert indicator

EMU26603

Digital speedometer

This gauge shows the boat speed and other information.

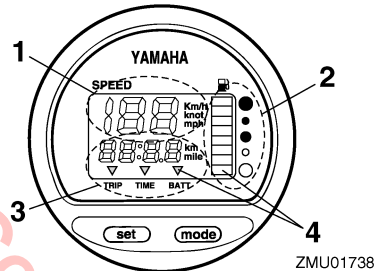

1. Speedometer
2. Fuel gauge
3. Trip meter/clock/voltmeter
4. Alert indicator(s)

All segments of the display will light momentarily after the main switch is turned on and will return to normal thereafter.

EMU36062

Speedometer

The speedometer displays km/h, mph, or knots, according to operator preference. Select the desired units of measurement by setting the selector switch on the back of the gauge. See the illustration for settings.

Instruments and indicators

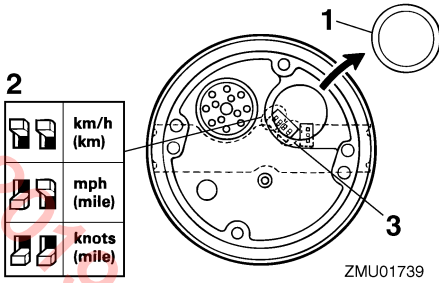

ZMU01739

1. Cap
2. Selector switch (for speed unit)
3. Selector switch (for fuel sensor)

EMU26714

Fuel gauge

Eight segments indicate the fuel level. When all segments are showing, the fuel tank is full.

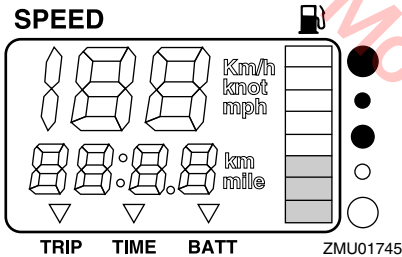

ZMU01745

The fuel level reading can be inaccurate due to the position of the sensor in the fuel tank and the attitude of the boat in the water. Operation with bow-up trim or continuous turning can give false readings.

Do not adjust the selector switch for fuel sensor. Incorrectly setting the selector switch on the gauge will give false readings. Consult your Yamaha dealer on how to correctly set the selector switch. **NOTICE: Running out of fuel can damage the engine.** [ECM01771]

EMU36072

Trip meter / Clock / Voltmeter

The display shows either the trip meter, the clock, or the voltmeter.

To change the display, press the “mode” (mode) button repeatedly until the indicator on the face of the gauge points to “TRIP” (trip meter), “TIME” (clock), or “BATT” (voltmeter).

EMU26692

Trip meter

This gauge displays the distance the boat has traveled since the gauge was last reset.

The trip distance is shown in kilometers or miles depending upon the unit of measurement selected for the speedometer.

To reset the trip meter to zero, press the “set” (set) and “mode” (mode) buttons at the same time.

The trip distance is kept in memory by battery power. The stored data will be lost if the battery is disconnected.

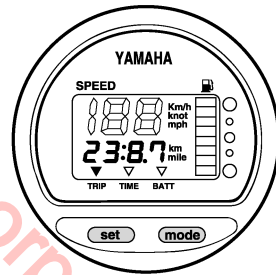

ZMU01743

EMU26702

Clock

To set the clock:

1. Be sure the gauge is in the “TIME” (time) mode.
2. Press the “set” (set) button; the hour display will begin blinking.
3. Press the “mode” (mode) button until the desired hour is displayed.
4. Press the “set” (set) button again, the minute display will begin blinking.
5. Press the “mode” (mode) button until the desired minute is displayed.
6. Press the “set” (set) button again to start the clock.

Instruments and indicators

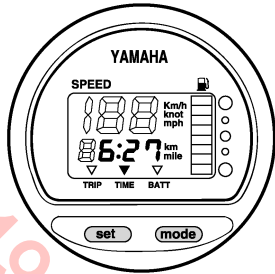

ZMU01744

The clock operates on battery power. Disconnecting the battery will stop the clock. Reset the clock after connecting the battery.

EMU36081

Voltmeter

The voltmeter displays the charge of the battery in volts(V).

EMU26722

Fuel level-alert indicator

If the fuel level decreases to one segment, the fuel level alert segment will blink.

Do not continue to operate the engine with full throttle if an alert device has activated. Get back to the port within trolling engine speed. **NOTICE: Running out of fuel can damage the engine.** [ECM01771]

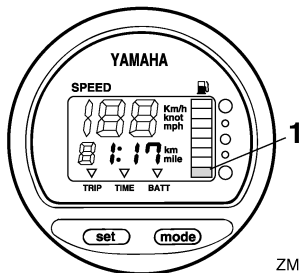

ZMU01746

1. Fuel level-alert segment

EMU26733

Low battery voltage-alert indicator

If battery voltage drops, the display will automatically turn on and blink.

Get back to the port soon if an alert device has activated. For charging the battery, consult your Yamaha dealer.

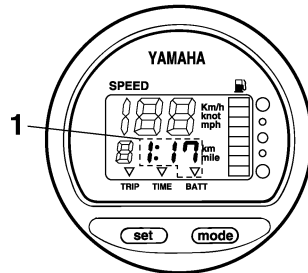

ZMU01747

1. Low battery indicator

EMU26742

Fuel management meter

The fuel management meter shows the state of the fuel consumption while the engine is running.

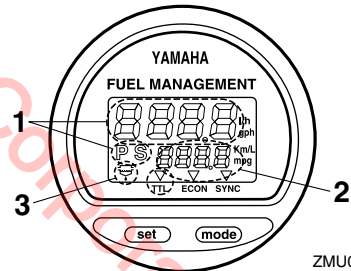

ZMU01748

1. Fuel flow meter
2. Fuel consumption meter / Fuel economy meter / Twin engine speed synchronizer
3. Water separator-alert indicator (operates only if the sensor has been installed)

All segments of the display will light momentarily after the main switch is turned on and will return to normal thereafter.

EMU26753

Fuel flow meter

The fuel flow meter displays the amount of fuel flow over a one-hour period, at the current rate of engine operation.

Instruments and indicators

- The fuel flow meter displays gallons/hour or liters/hour according to operator preference. Select the desired units of measurement by setting the selector switch on the back of the gauge during installation.

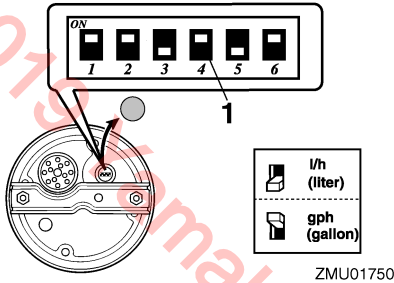

1. Selector switch

- The fuel consumption meter and fuel economy meter will indicate the same unit of measurement.

Fuel flow readings are not accurate when the engine is operating under about 1300 r/min. As the fuel pump cycles on and off, the display indicates either no fuel flow or higher flow than the actual average use.

Dual engine users: the fuel flow meter can display the fuel flow of either or both engines.

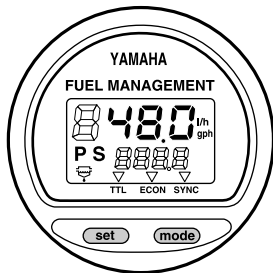

ZMU01749

To change the fuel flow display, press the “set” (set) button repeatedly until the gauge displays “S” (for fuel flow to the starboard en-

gine only), “P” (for fuel flow to the port engine only), or “P S” (for total fuel flow both engines).

EMU36091

Fuel consumption meter / Fuel economy meter / Twin engine speed synchronizer

The display shows either the fuel consumption meter, the fuel economy meter, or the twin engine synchronizer.

To change the display, press the “mode” (mode) button repeatedly until the indicator on the face of the gauge points to “TTL” (fuel consumption meter), “ECON” (fuel economy meter), or “SYNC” (twin engine speed synchronizer).

EMU26762

Fuel consumption meter

This gauge displays the total amount of fuel consumed since the gauge was last reset.

To reset the total fuel consumption meter to zero, press the “set” (set) and “mode” (mode) buttons at the same time.

FUEL MANAGEMENT

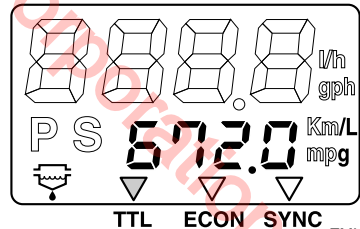

ZMU01751

EMU26772

Fuel economy

This gauge displays the approximate distance per liter or gallon when cruising.

Instruments and indicators

FUEL MANAGEMENT

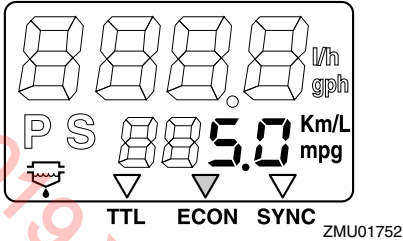

If twin engines are installed on your boat, the gauge will only display the total fuel economy of both engines.

- Fuel consumption varies greatly with boat design, weight, propeller used, engine trim angle, sea conditions (including wind), and throttle position. Fuel consumption also varies slightly with the type of water (salt, fresh, and contaminate levels), air temperature and humidity, cleanliness of the boat bottom, engine mounting height, skill of the operator, and individual gasoline formulation (winter or summer fuel and amount of additives).
- The Yamaha digital speedometer and fuel management meter calculates speed, miles traveled, and fuel economy by water movement at the stern of the boat. This distance can vary greatly from the actual distance traveled because of water currents, sea swells, and the condition of the water speed sensor (if partially plugged or damaged).
- Individual engines may slightly vary in their fuel consumption due to manufacturing variations. These variations can be even greater if the engines are of different year models. In addition, variations in propellers, even of the same basic dimensions of the same design, can also cause a slight variation in fuel consumption.

EMU26783

Twin-engine speed synchronizer

This gauge displays the difference in engine speed (r/min) between the port and starboard engines for reference purposes when synchronizing the two engines' speeds.

FUEL MANAGEMENT

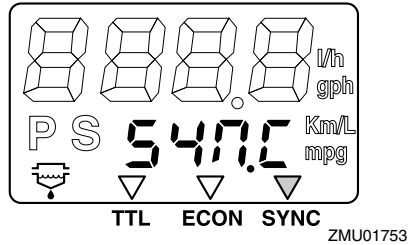

FUEL MANAGEMENT

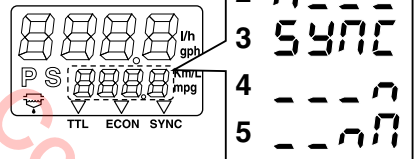

1. Port engine speed is higher
2. Port engine speed is slightly higher
3. Engine speed is synchronized evenly between port and starboard engines
4. Starboard engine speed is slightly higher
5. Starboard engine speed is higher

If the two engines' speeds are not synchronized while cruising, adjusting trim angle or throttle can synchronize them.

If large differences in trim angle or throttle are needed to synchronize the engines, consult your Yamaha dealer for adjustments to the throttle cables.

Instruments and indicators

EMU26794

Water separator-alert indicator

This indicator will blink when water has accumulated in the water separator. In such an event, stop the engine and drain the water from the separator.

This indicator only operates when a water separator sensor is equipped.

FUEL MANAGEMENT

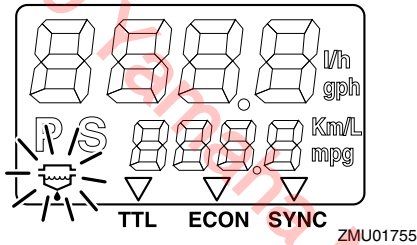

EMU31654

6Y8 Multifunction meters

Multifunction meters have 6 kinds of meter units; tachometer unit (square or round types), speedometer unit (square type), speed & fuel meter unit (square or round types), and fuel management meter (square type). The indicator system is slightly different between the round and square types. Check the model and type of your unit carefully. This manual describes mainly the alert indicators. For more details on setting meters or changing indicator systems, see the attached operation manual.

EMU36185

6Y8 Multifunction tachometers

The tachometer shows the engine revolutions per minute. It has functions of trim meter, adjusting trolling speed, cooling water/engine temperature display, battery voltage display, total hour/trip hour display, oil pressure display, water detection alert, engine trouble alert, and periodic maintenance notification. If the cooling water pressure sensor is in-

stalled, the unit can also show the cooling water pressure display. However, even if the cooling water pressure sensor is not installed, the cooling water pressure display can be shown by connecting an optional sensor to the unit. For the optional sensor, consult your Yamaha dealer. The tachometer unit is available in round or square types. Check your tachometer unit type.

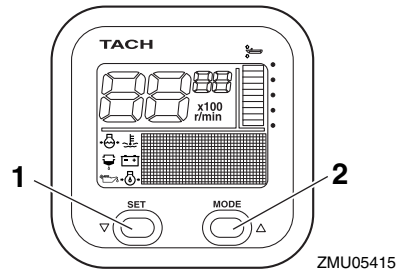

1. Set button
2. Mode button

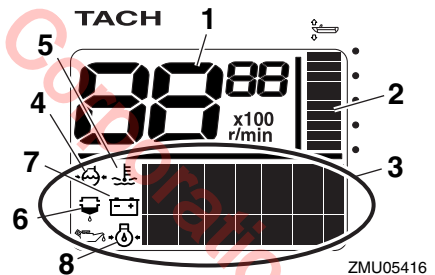

1. Tachometer
2. Trim meter
3. Multifunction display
4. Cooling water pressure
5. Cooling water/engine temperature
6. Water detection-alert indicator
7. Battery voltage
8. Oil pressure (4-stroke models)

Instruments and indicators

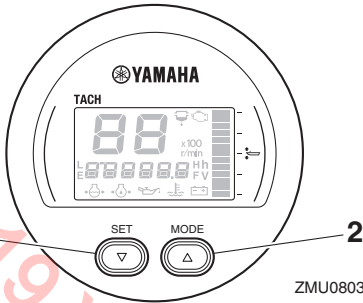

1. Set button
2. Mode button

ZMU08035

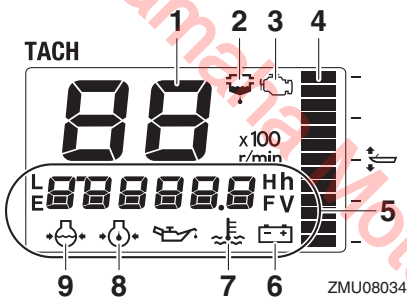

1. Tachometer
2. Water detection-alert indicator
3. Engine trouble alert/maintenance indicator
4. Trim meter
5. Multifunction display
6. Battery voltage
7. Cooling water/engine temperature
8. Oil pressure (4-stroke models)
9. Cooling water pressure

EMU36111

Start-up checks

Place the remote control lever in neutral and turn the main switch to “ON” (on). After all the displays come on and the total hour display comes on, the gauge will change to normal operation. If the buzzer sounds and the water separator-alert indicator blinks, consult your Yamaha dealer immediately.

TIP:

To stop the buzzer, press the “set” (set) or “mode” (mode) button.

EMU36131

Low oil pressure-alert

If the engine oil pressure drops too low, the low oil pressure-alert indicator will start to blink, and the engine speed will automatically decrease to about 2000 r/min.

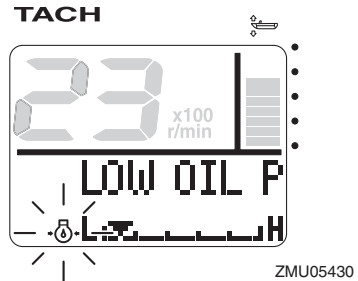

ZMU05430

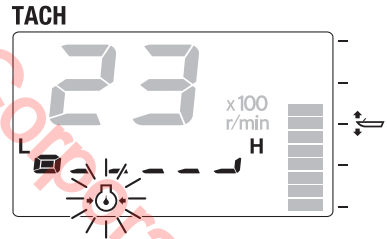

ZMU05431

Stop the engine immediately if the buzzer sounds and the low oil pressure-alert indicator blinks. Check the engine oil quantity and replenish oil if necessary. If the alert device has activated while the appropriate engine oil quantity is maintained, consult your Yamaha dealer.

ECM01602

NOTICE

Do not continue to run the engine if the low oil pressure alert device has activated. Serious engine damage will occur.

Instruments and indicators

EMU36222

Overheat alert

If the engine temperature rises too high while cruising, the overheat-alert indicator will start to blink. The engine speed will automatically decrease to about 2000 r/min.

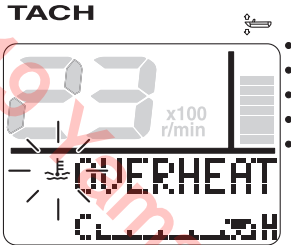

ZMU05421

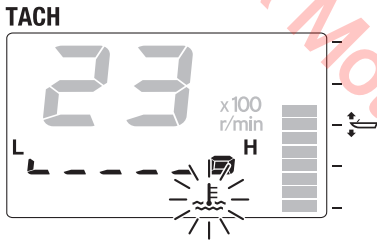

ZMU05422

Stop the engine immediately if the buzzer sounds and the overheat alert device has activated. Check the cooling water inlet for clogging.

ECM01593

NOTICE

- Do not continue to run the engine if the overheat-alert indicator blinks. Serious engine damage will occur.
- Do not continue to operate the engine if a alert device has activated. Consult your Yamaha dealer if the problem cannot be located and corrected.

EMU36151

Water separator alert

This indicator will blink if water has accumulated in the water separator (fuel filter) while cruising. In such an event, stop the engine immediately and see page 92 of this manual to drain the water from the fuel filter. Get back to the port soon and consult a Yamaha dealer immediately.

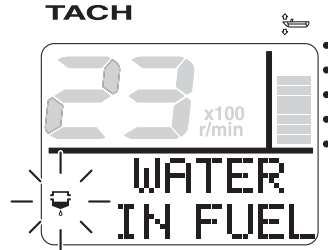

ZMU05423

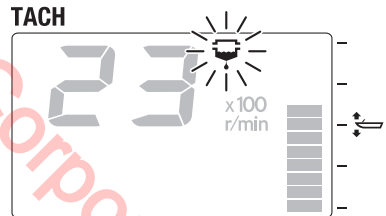

ZMU05424

ECM00911

NOTICE

Gasoline mixed with water could cause damage to the engine.

EMU36161

Engine trouble alert

This indicator will blink if the engine malfunctions while cruising. Get back to the port soon and consult a Yamaha dealer immediately.

TACH

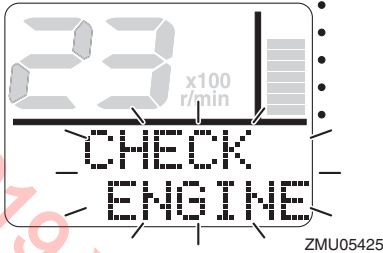

TACH

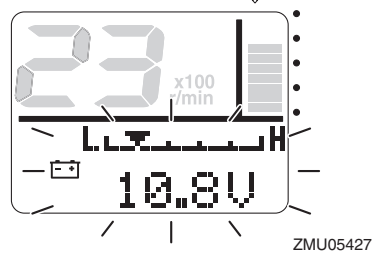

TACH

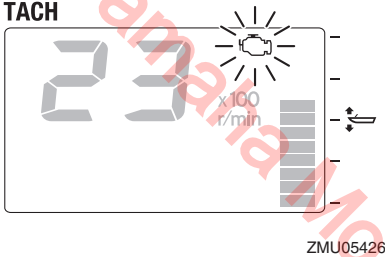

TACH

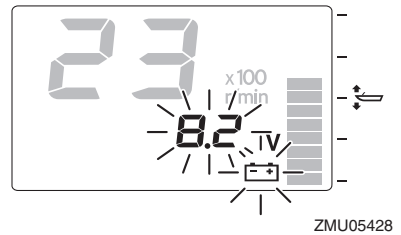

ECM00921

NOTICE

In such an event, the engine will not operate properly. Consult a Yamaha dealer immediately.

EMU36171

Low battery voltage-alert

If the battery voltage drops, the low battery voltage-alert indicator and the battery voltage value will start to blink. Get back to the port soon if the low battery voltage-alert device has activated. For charging the battery, consult your Yamaha dealer.

EMU36233

6Y8 Multifunction speed & fuel meters

The speed & fuel meter unit shows the boat speed and has the functions of fuel meter, total fuel consumption display, fuel economy display, fuel flow display, and system voltage display. The chosen display is selected by using the "set" (set) and "mode" (mode) buttons as described in this section. If the speed sensor is installed, the unit can also show the trip display. However, even if the speed sensor is not installed, the trip display can be shown by connecting an optional sensor to the unit. In addition, if optional sensors are connected to the unit, water surface temperature display, depth display, and clock will also be available. For the optional sensors, consult your Yamaha dealer.

Instruments and indicators

The speed & fuel meter unit is available in round or square types. Check your speed & fuel meter unit type for operation information. After the main switch is first turned on, all the displays come on as a test. After a few seconds, the gauge will change to normal operation.

For more information, see the operation manual originally supplied with the meter.

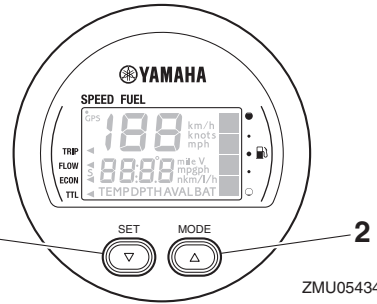

ZMU05434

1. Set button
2. Mode button

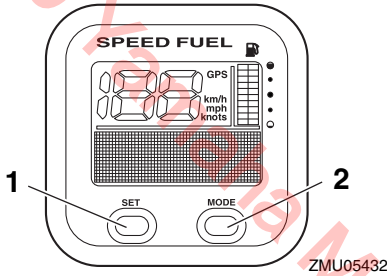

ZMU05432

1. Set button
2. Mode button

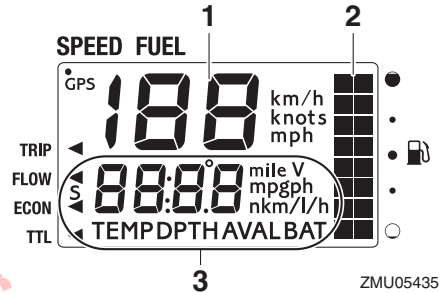

ZMU05435

1. Speedometer
2. Fuel meter
3. Multifunction display

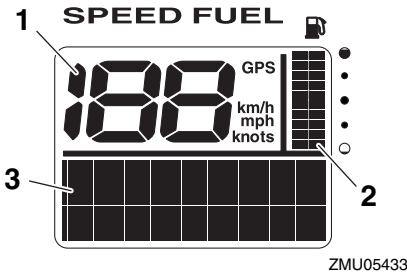

ZMU05433

1. Speedometer
2. Fuel meter
3. Multifunction display

EMU36242

6Y8 Multifunction speedometers

The speedometer unit shows the boat speed and has functions of fuel meter and system voltage display. The chosen display is selected by using the "set" (set) and "mode" (mode) buttons as described in this section. In addition, the speedometer can show the desired unit of measurement such as km/h, mph, or knots. If the speed sensor is installed, the unit can also show the trip display. However, even if the speed sensor is not installed, the trip display can be shown by connecting an optional sensor to the unit. In addition, if optional sensors are connected to the unit, water surface temperature display, depth

Instruments and indicators

display, and clock will also be available. For the optional sensors, consult your Yamaha dealer.

After the main switch is first turned on, all the displays come on as a test. After a few seconds, the gauge will change to normal operation.

For more information, see the operation manual originally supplied with the meter.

buttons as described in this section. For more information, see the operation manual originally supplied with the meter.

After the main switch is first turned on, all the displays come on as a test. After a few seconds, the gauge will change to normal operation.

For more information, see the operation manual originally supplied with the meter.

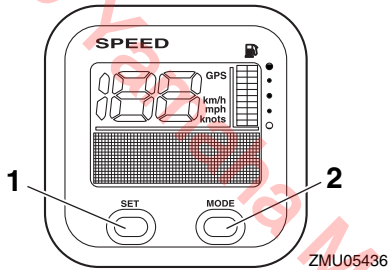

1. Set button
2. Mode button

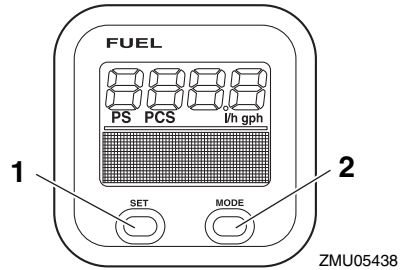

1. Set button
2. Mode button

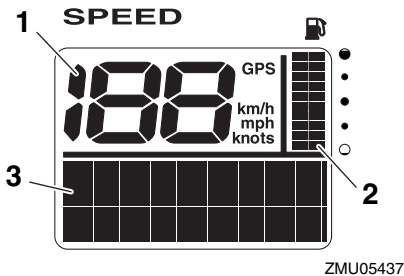

1. Speedometer
2. Fuel meter
3. Multifunction display

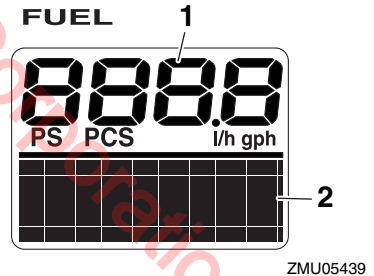

1. Fuel flow meter
2. Multifunction display

EMU36251

6Y8 Multifunction fuel management meters

The fuel management meter has the functions of fuel flow meter, total consumption display, fuel economy display, and remaining fuel display. The chosen display is selected by using the “set” (set) and “mode” (mode)

Engine control system

EMU26804

Alert system

ECM00092

NOTICE

Do not continue to operate the engine if a alert device has activated. Consult your Yamaha dealer if the problem cannot be located and corrected.

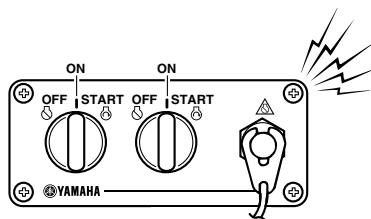

EMU26828

Overheat alert

This engine has the overheat alert device. If the engine temperature rises too high, the alert device will activate.

- The engine speed will automatically decrease to about 2000 r/min.
- The overheat-alert indicator will light or blink.

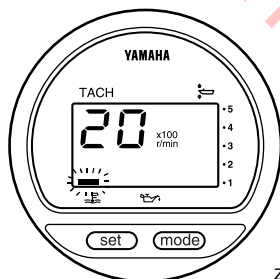

ZMU01757

- The buzzer will sound.

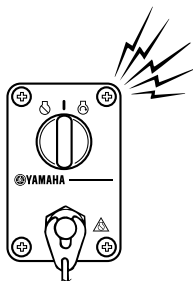

ZMU04583

ZMU05827

If the alert system has activated, stop the engine and check the cooling water inlets:

- Check trim angle to be sure that the cooling water inlet is submerged.
- Check the cooling water inlet for clogging.

Dual engine drive users:

If the overheat-alert system of one engine activates, the engine will slow down. To switch off the alert activation on the engine not affected by overheating, turn off the main switch of the engine overheating. If the alert system has activated, stop the engine and tilt the outboard motor up to check the cooling water inlet for clogging. If the alert system has still activated, tilt the overheated outboard motor up and return to the port.

EMU35026

Low oil pressure alert

If the oil pressure drops too low, the alert device will activate.

- The engine speed will automatically decrease to about 2000 r/min. The low oil pressure-alert indicator will light or blink.

Engine control system

alert activation on the engine not affected by low oil pressure, turn off the main switch of the engine with the low oil pressure.

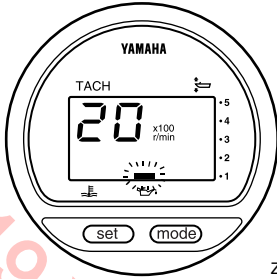

ZMU01828

- The buzzer will sound.

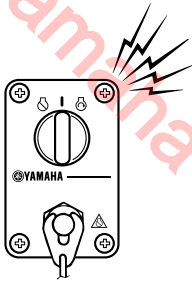

ZMU04583

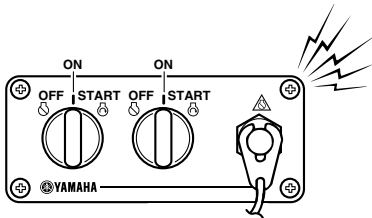

ZMU05827

If the alert system has activated, stop the engine as soon as it is safe to do so. Check the oil level and add oil as needed. If the oil level is correct and the alert device does not switch off, consult your Yamaha dealer.

Twin engine drive users:

If the low oil pressure alert system of one engine activates, both engines will slow down and the buzzer will sound. To switch off the

Installation

EMU26903

Installation

The information presented in this section is intended as reference only. It is not possible to provide complete instructions for every possible boat and motor combination. Proper mounting depends in part on experience and the specific boat and motor combination.

EWM01591

WARNING

- **Overpowering a boat could cause severe instability. Do not install an outboard motor with more horsepower than the maximum rating on the capacity plate of the boat. If the boat does not have a capacity plate, consult the boat manufacturer.**
- **Improper mounting of the outboard motor could result in hazardous conditions such as poor handling, loss of control, or fire hazards. For permanently mounted models, your dealer or other person experienced in proper rigging should mount the motor.**

EMU33482

Mounting the outboard motor

The outboard motor should be mounted so that the boat is well balanced. Otherwise, the boat could be hard to steer. For single-engine boats, mount the outboard motor on the centerline (keel line) of the boat. For twin engine boats, mount the outboard motors equidistant from the centerline. Consult your Yamaha dealer or boat manufacturer for further information on determining the proper mounting location.

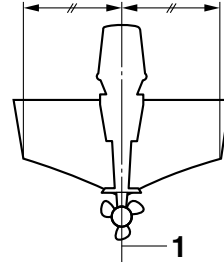

ZMU01760

1. Center line (keel line)

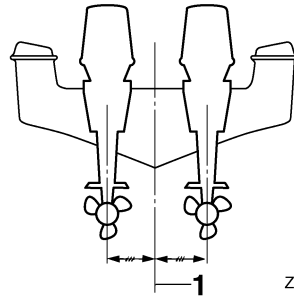

ZMU05141

1. Center line (keel line)

EMU26935

Mounting height (boat bottom)

The mounting height of your outboard motor affects its efficiency and reliability. If it is mounted too high, propeller ventilation may occur, which will reduce propulsion due to excessive propeller slip, and the water intakes for the cooling system may not get adequate water supply, which can cause engine overheating. If the engine is mounted too low, water resistance (drag) will increase, thereby reducing engine efficiency and performance. Most commonly, outboard motor should be mounted so that the anti-cavitation plate is in alignment with the bottom of the boat. The optimum mounting height of the outboard motor is affected by the boat/motor combination and the desired use. Test runs at different heights can help determine the optimum mounting height. Consult your

Yamaha dealer or boat manufacturer for further information on determining the proper mounting height.

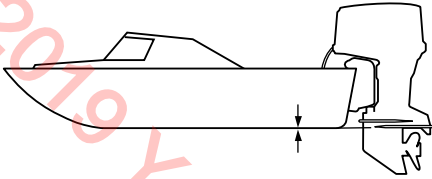

ZMU01762

ECM01635

NOTICE

- Make sure that the idle hole is high enough to prevent water from entering the engine even if the boat is stationary with the maximum load.
- Incorrect engine height or obstructions to the smooth flow of water (such as the design or condition of the boat, or accessories, such as transom ladders or depth finder transducers) can create airborne water spray while the boat is cruising. If the outboard motor is operated continuously in the presence of airborne water spray, enough water could enter the engine through the air intake opening in the top cowling to cause severe engine damage. Remove the cause of the airborne water spray.

Operation

EMU36382

First-time operation

EMU36393

Fill engine oil

The engine is shipped from the factory without engine oil. If your dealer did not fill the oil, you must fill it before starting the engine.

NOTICE: Check that the engine is filled with oil before first-time operation to avoid severe engine damage. [ECM01782]

The engine is shipped with the following tag, which should be removed after engine oil is filled for the first time. For more information on checking the engine oil level, see page 50.

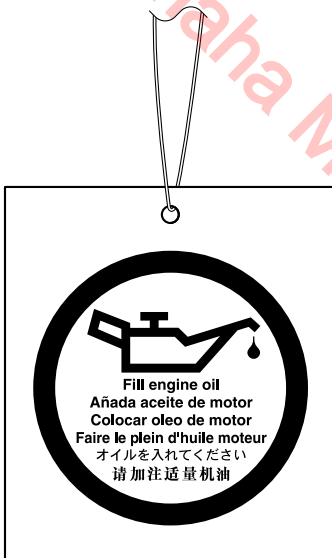

ZMU01710

EMU30175

Breaking in engine

Your new engine requires a period of break-in to allow mating surfaces of moving parts to wear in evenly. Correct break-in will help ensure proper performance and longer engine life. **NOTICE: Failure to follow the break-in procedure could result in reduced engine life or even severe engine damage.** [ECM00802]

EMU27086

Procedure for 4-stroke models

Your new engine requires a period of 10 hours break-in to allow mating surfaces of moving parts to wear in evenly.

TIP:

Run the engine in the water, under load (in gear with a propeller installed) as follows. For 10 hours for breaking in engine avoid extended idling, rough water and crowded areas.

1. For the first hour of operation:
Run the engine at varying speeds up to 2000 r/min or approximately half throttle.
2. For the second hour of operation:
Increase engine speed as much as necessary to put the boat on plane (but avoid full-throttle operation), then back off on the throttle while keeping the boat at a planing speed.
3. Remaining 8 hours:
Run the engine at any speed. However, avoid operating at full throttle for more than 5 minutes at a time.
4. After the first 10 hours:
Operate the engine normally.

EMU36402

Getting to know your boat

All boats have unique handling characteristics. Operate cautiously while you learn how your boat handles under different conditions and various trim angles (see page 58).

EMU36414

Checks before starting engine

EWMO1922



If any item in "Checks before starting engine" is not working properly, have it inspected and repaired before operating the outboard motor. Otherwise, an accident could occur.

ECM00121

NOTICE

Do not start the engine out of water. Overheating and serious engine damage can occur.

EMU36422

Fuel level

Be sure you have plenty of fuel for your trip. A good rule is to use 1/3 of your fuel to get to the destination, 1/3 to return, and to keep 1/3 as an emergency reserve. With the boat level on a trailer or in the water, turn the key to "ON" (on) and check the fuel level. For fuel filling instructions, see page 53.

EMU36433

Remove cowling

For the following checks, remove the top cowling from the engine. To remove the engine cowling, release all the lock levers and lift off the cowling.

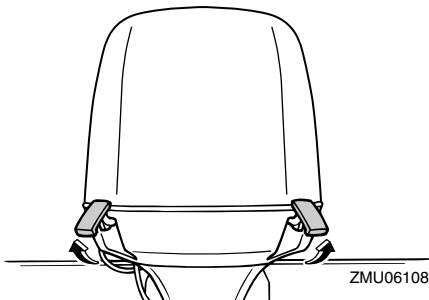
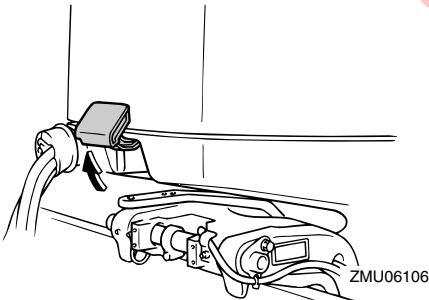

EMU36443

Fuel system

EWM00061

WARNING

Gasoline and its vapors are highly flammable and explosive. Keep away from sparks, cigarettes, flames, or other sources of ignition.

EWM00911

WARNING

Leaking fuel can result in fire or explosion.

- Check for fuel leakage regularly.
- If any fuel leakage is found, the fuel system must be repaired by a qualified mechanic. Improper repairs can make the outboard unsafe to operate.

EMU36452

Check for fuel leaks

- Check for fuel leaks or gasoline fumes in the boat.
- Check for fuel leakage from the fuel system.
- Check the fuel tank and fuel lines for cracks, swellings, or other damages.

EMU37323

Checking the fuel filter

Check that the fuel filter is clean and free of water. If any water is found in the fuel, or if a significant amount of debris is found, the fuel tank should be checked and cleaned by a Yamaha dealer.

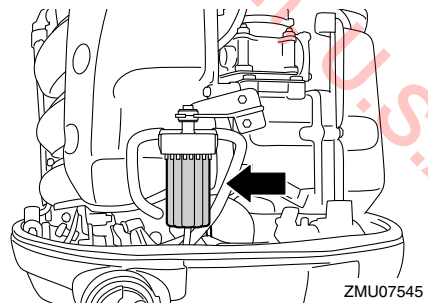

Operation

EMU36463

Controls

- Turn the steering wheel full-right and full-left. Make sure operation is smooth and unrestricted throughout the whole range with no binding or excessive free play.
- Operate the throttle levers several times to make sure there is no hesitation in their travel. Operation should be smooth over the complete range of motion, and each lever should return completely to the idle position.
- Look for loose or damaged connections of the throttle and shift cables.

EMU36484

Engine shut-off cord (lanyard)

Inspect the engine shut-off cord and clip for damage, such as cuts, breaks, and wear.

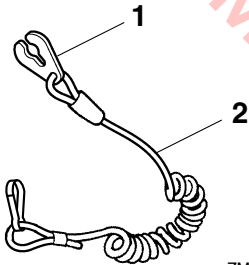

ZMU06873

1. Clip
2. Engine shut-off cord (lanyard)

EMU40994

Engine oil

1. Place the outboard motor in a vertical position (not tilted). **NOTICE: If the outboard motor is not level, the oil level indicated on the oil dipstick may not be accurate.** [ECM01862]
2. Remove the oil dipstick and wipe it clean.

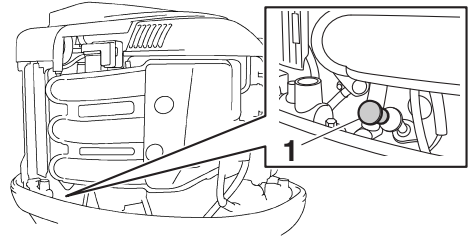

ZMU05972

1. Oil dipstick
3. Insert the oil dipstick completely and remove it again.
4. Check that the oil level on the oil dipstick is between the upper and lower marks. Consult your Yamaha dealer if the oil level is not at the proper level or if it appears milky or dirty.

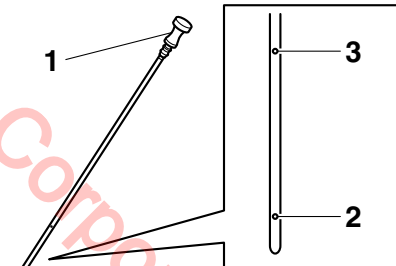

ZMU07057

1. Oil dipstick
2. Lower mark
3. Upper mark

EMU27154

Engine

- Check the engine and engine mounting.
- Look for loose or damaged fasteners.
- Check the propeller for damage.
- Check for engine oil leaks.

EMU36494

Flushing device

Check that the flushing device's garden hose connector is securely screwed on to the fitting on the bottom cowling. **NOTICE: If the**

garden hose connector is not properly connected, cooling water can leak out and the engine can overheat during operation.

[ECM01802]

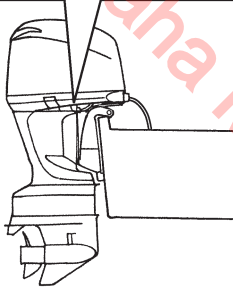
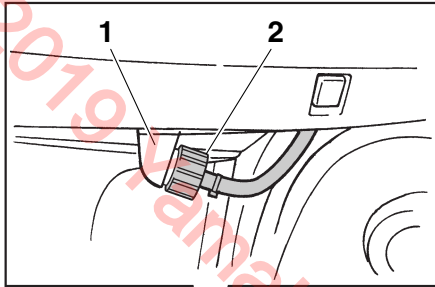

ZMU06164

1. Fitting
2. Flushing device

EMU36942

Install cowling

1. Be sure that all cowling lock levers are released.
2. Be sure that the rubber seal is seated all the way around the engine.
3. Place the cowling on top of the seal.
4. Check to be sure it fits properly in the rubber seal.
5. Move the levers to lock the cowling as shown. **NOTICE: If the top cowling is not installed correctly, water spray under the top cowling can damage the engine, or the top cowling can blow off at high speeds.** [ECM01992]

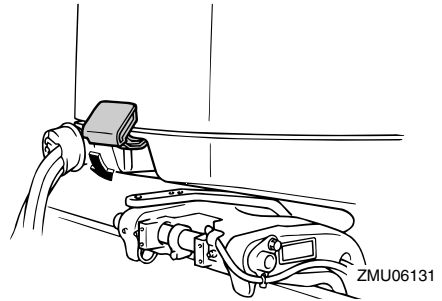

ZMU06131

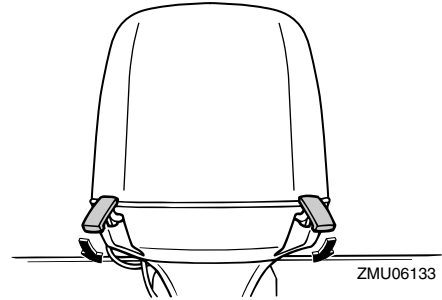

ZMU06133

After installing, check the fitting of the top cowling by pushing it with both hands. If the top cowling is loose, have it repaired by your Yamaha dealer.

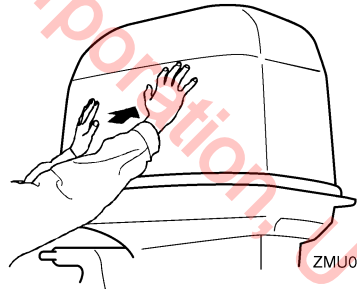

ZMU05175

Operation

EMU2915A

Checking power trim and tilt system

EWM01931

WARNING

- Never get under the lower unit while it is tilted, even when the tilt support lever is locked. Severe injury could occur if the outboard motor accidentally falls.
- Body parts can be crushed between the motor and the clamp bracket when the motor is trimmed or tilted.
- Be sure no one is near the outboard motor before performing this check.

1. Check the power trim and tilt unit for any sign of oil leaks.
2. Operate each of the power trim and tilt switches on the remote control and engine bottom cowling to check that all switches work.
3. Tilt the outboard motor up and check that the tilt rod and trim rods are extended completely.

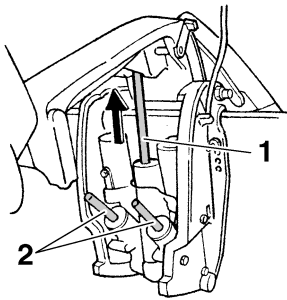

ZMU05471

1. Tilt rod
 2. Trim rods
4. Use the tilt support lever to lock the motor in the up position. Operate the tilt down switch briefly so the motor is supported by the tilt support lever.

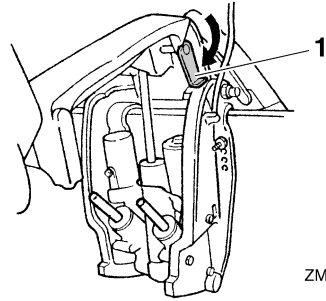

ZMU05472

1. Tilt support lever
5. Check that the tilt rod and trim rods are free of corrosion or other flaws.
 6. Activate the tilt-down switch until the trim rods have retracted completely into the cylinders.

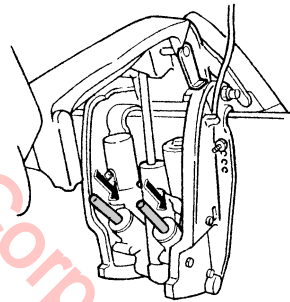

ZMU05473

7. Activate the trim-up switch until the tilt rod is fully extended. Unlock the tilt support lever.

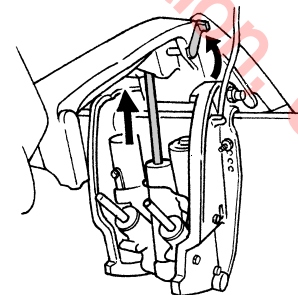

ZMU01885

8. Tilt the outboard motor down. Check that the tilt rod and trim rods operate smoothly.

EMU36583

Battery

Check that the battery is in good condition, and fully charged. Check that the battery connections are clean, secure and covered by insulating covers. The electrical contacts of the battery and cables must be clean and properly connected or the battery will not start the engine.

Refer to the battery manufacturer's instructions for checks for your particular battery.

EMU30027

Filling fuel

EWM01831



- Gasoline and its vapors are highly flammable and explosive. Always refuel according to this procedure to reduce the risk of fire and explosion.
- Gasoline is poisonous and can cause injury or death. Handle gasoline with care. Never siphon gasoline by mouth. If you should swallow some gasoline or inhale a lot of gasoline vapor, or get some gasoline in your eyes, see your doctor immediately. If gasoline spills on your skin, wash with soap and water. If gasoline spills on your clothing, change your clothes.

1. Make sure that the engine is stopped.
2. Make sure that the boat is in a well-ventilated outdoor area, either securely moored or trailered.
3. Make sure that no one is in the boat.
4. Do not smoke and keep away from sparks, flames, static electric discharge, or other sources of ignition.

5. If you use a portable container to store and dispense fuel, only use a locally approved GASOLINE container.
6. Touch the fuel nozzle to the filler opening or funnel to help prevent electrostatic sparks.
7. Fill the fuel tank, but do not overfill. **WARNING! Do not overfill. Otherwise fuel can expand and overflow if the temperature increases.** [EWM02611]
8. Tighten the fuel tank cap securely.
9. Wipe up any spilled gasoline immediately with dry rags. Dispose of rags properly according to local laws or regulations.

EMU27453

Operating engine

EWM00421



- Before starting the engine, make sure that the boat is tightly moored and that you can steer clear of any obstructions. Be sure there are no swimmers in the water near you.
- When the air vent screw is loosened, gasoline vapor will be released. Gasoline is highly flammable, and its vapors are flammable and explosive. Refrain from smoking, and keep away from open flames and sparks while loosening the air vent screw.
- This product emits exhaust gases which contain carbon monoxide, a colorless, odorless gas which could cause brain damage or death when inhaled. Symptoms include nausea, dizziness, and drowsiness. Keep cockpit and cabin areas well ventilated. Avoid blocking exhaust outlets.

Operation

EMU31814

Sending fuel

1. If there is a fuel joint or a fuel valve on the boat, firmly connect the fuel line to the joint or open the fuel valve.
2. Squeeze the primer pump, with the arrow pointing up, until you feel it become firm.

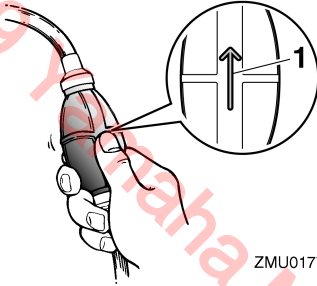

ZMU01770

1. Arrow

EMU27495

Starting engine

EWM01601

WARNING

Before starting the engine, make sure that the boat is tightly moored and that you can steer clear of any obstructions. Be sure there are no swimmers in the water near you.

EMU2762A

Electric start and remote control models

EWM01841

WARNING

- Failure to attached engine shut-off cord could result in a runaway boat if operator is ejected. Attach the engine shut-off cord to a secure place on your clothing, or your arm or leg while operating. Do not attach the cord to clothing that could tear loose. Do not route the cord where it could become entangled, preventing it from functioning.

- Avoid accidentally pulling the cord during normal operation. Loss of engine power means the loss of most steering control. Also, without engine power, the boat could slow rapidly. This could cause people and objects in the boat to be thrown forward.

1. Place the remote control lever in "N" (neutral).

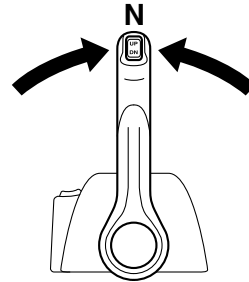

ZMU04588

TIP:

The start-in-gear protection device prevents the engine from starting except when in neutral.

2. Attach the engine shut-off cord to a secure place on your clothing, or your arm or leg. Then install the clip on the other end of the cord into the engine shut-off switch.

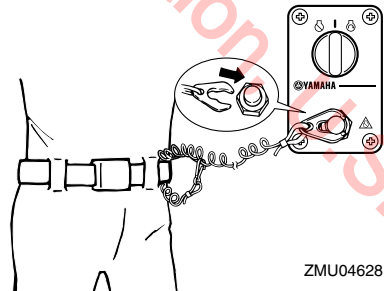

ZMU04628

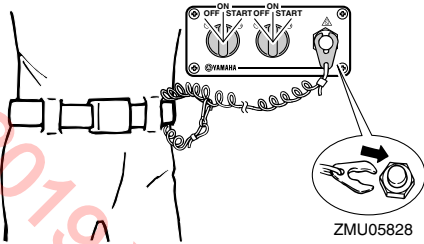

3. Turn the main switch to “ON” (on).

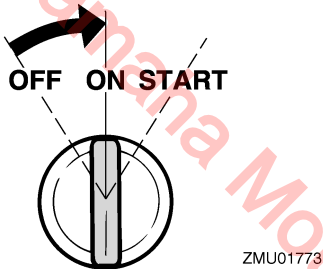

TIP:

Dual engine users: When the main switch is turned on, the buzzer operates for a few seconds then stops automatically. The buzzer also operates if one of the engines stalls.

4. Turn the main switch to “START” (start), and hold it for a maximum of 5 seconds.

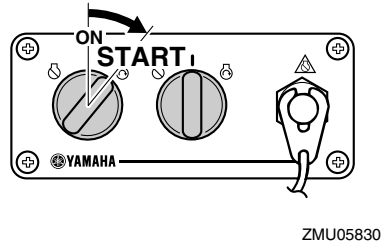
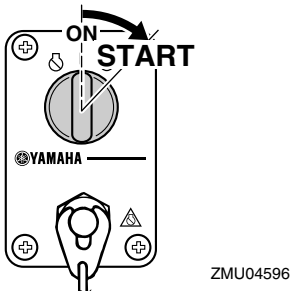

5. Immediately after the engine starts, release the main switch to return it to “ON” (on). **NOTICE: Never turn the main switch to “START” (start) while the engine is running. Do not keep the starter motor turning for more than 5 seconds. If the starter motor is turned continuously for more than 5 seconds, the battery will be quickly discharged, thus making it impossible to start the engine. The starter can also be damaged. If the engine will not start after 5 seconds of cranking, return the main switch to “ON” (on), wait 10 seconds, then crank the engine again.** [ECM00193]

EMUJ36511

Checks after starting engine

EMUJ36524

Cooling water

Check for a steady flow of water from the cooling water pilot hole. A continuous flow of water from the pilot hole indicates that the water pump is pumping water through the cooling water passages. If the cooling water passages are frozen, it may take a while for water to start flowing out of the pilot hole.

ECM01811

NOTICE

If water is not flowing out of the pilot hole at all times while the engine is running, overheating and serious damage could occur. Stop the engine and check whether

Operation

the cooling water inlet on the lower case or the cooling water pilot hole is blocked. Consult your Yamaha dealer if the problem cannot be located and corrected.

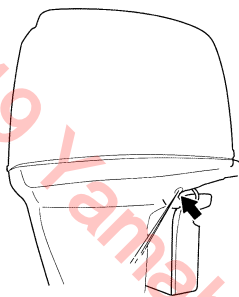

ZMU05169

EMU27671

Warming up engine

EMU30038

Electric start models

1. After starting the engine, allow it to idle for 3 minutes to warm up to provide maximum operating performance and acceleration. Failure to do so will shorten engine life.
2. Be sure the low oil pressure-alert indicator remains off after starting the engine.

NOTICE: If the low oil pressure-alert indicator blinks after the engine starts, stop the engine. Otherwise, serious engine damage could occur. Check the oil level and add engine oil if necessary. Consult your Yamaha dealer if the cause for the low oil pressure alert cannot be found. [ECM01832]

EMU36532

Checks after engine warm up

EMU36542

Shifting

While the boat is tightly moored, and without applying throttle, confirm that the engine shifts smoothly into forward and reverse, and back to neutral.

EMU31722

Stop switches

- Confirm that turning the main switch to the "OFF" (off) position stops the engine.
- Confirm that removing the clip from the engine shut-off switch stops the engine.
- Confirm that the engine cannot be started with the clip removed from the engine shut-off switch.

EMU31734

Shifting

EWM00181

WARNING

Before shifting, make sure there are no swimmers or obstacles in the water near you.

ECM01611

NOTICE

Warm up the engine before shifting into gear. Until the engine is warm, the idle speed may be higher than normal. High idle speed can prevent you from shifting back to neutral. If this occurs, stop the engine, shift to neutral, then restart the engine and allow it to warm up.

To shift out of neutral

1. Pull the neutral interlock trigger up (if equipped).
2. Move the remote control lever firmly and crisply forward (for forward gear) or rearward (for reverse gear) about 35° (a dent can be felt).

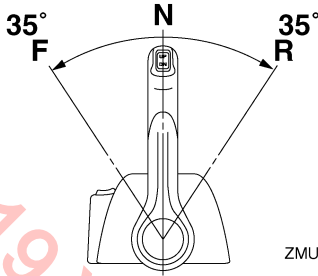

ZMU05461

To shift from in gear (forward/reverse) to neutral

1. Close the throttle so that the engine slows to idle speed.

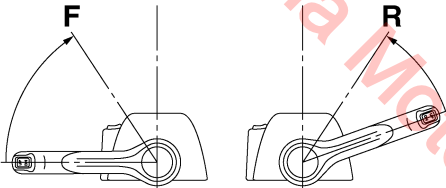

ZMU05463

2. After the engine is at idle speed in gear, move the remote control lever firmly and crisply to the neutral position.

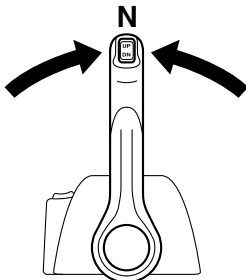

ZMU04588

EMU31743

Stopping boat

EWM01511

WARNING

- Do not use the reverse function to slow down or stop the boat as it could cause you to lose control, be ejected, or impact the steering wheel or other parts of the boat. This could increase the risk of serious injury. It could also damage the shift mechanism.
- Do not shift into reverse while traveling at planing speeds. Loss of control, boat swamping, or damage to the boat could occur.

The boat is not equipped with a separate braking system. Water resistance stops it after the throttle lever is moved back to idle. The stopping distance varies depending on gross weight, water surface conditions, and wind direction.

EMU27822

Stopping engine

Before stopping the engine, first let it cool off for a few minutes at idle or low speed. Stopping the engine immediately after operating at high speed is not recommended.

EMU31832

Procedure

1. Turn the main switch to "OFF" (off).

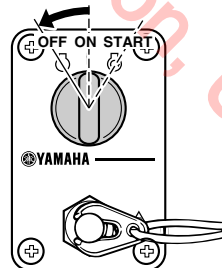

ZMU04599

Operation

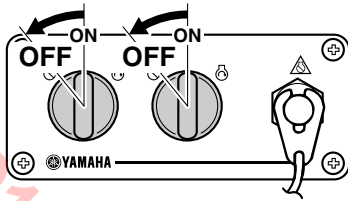

ZMU05833

2. Remove the key if the boat will be left unattended.

TIP:

The engine can also be stopped by pulling the cord and removing the clip from the engine shut-off switch, then turning the main switch to "OFF" (off).

EMU27864

Trimming outboard motor

EWM00741

WARNING

Excessive trim for the operating conditions (either trim up or trim down) can cause boat instability and can make steering the boat more difficult. This increases the possibility of an accident. If the boat begins to feel unstable or is hard to steer, slow down and/or readjust the trim angle.

The trim angle of the outboard motor helps determine the position of the bow of the boat in the water. Correct trim angle will help improve performance and fuel economy while reducing strain on the engine. Correct trim angle depends upon the combination of boat, engine, and propeller. Correct trim is also affected by variables such as the load in the boat, sea conditions, and running speed.

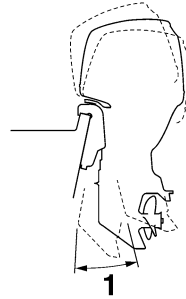

ZMU05170

1. Trim operating angle

EMU27889

Adjusting trim angle (Power trim and tilt)

EWM00754

WARNING

- Be sure all people are clear of the outboard motor when adjusting the trim angle. Body parts can be crushed between the motor and the clamp bracket when the motor is trimmed or tilted.
- Use caution when trying a trim position for the first time. Increase speed gradually and watch for any signs of instability or control problems. Improper trim angle can cause loss of control.
- If equipped with a power trim and tilt switch located on the bottom cowling, use the switch only when the boat is at a complete stop with the engine off. Do not adjust the trim angle with this switch while the boat is moving.

Adjust the outboard motor trim angle using the power trim and tilt switch.

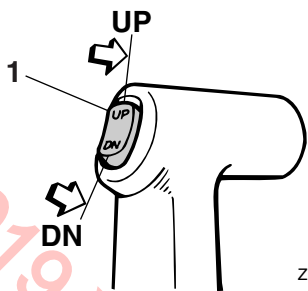

ZMU04193

1. Power trim and tilt switch

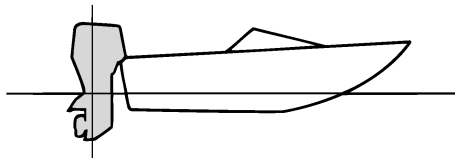

ZMU01784

Bow Up

Too much trim-out puts the bow of the boat too high in the water. Performance and economy are decreased because the hull of the boat is pushing the water and there is more air drag. Excessive trim-out can also cause the propeller to ventilate, which reduces performance further, and the boat may “porpoise” (hop in the water), which could throw the operator and passengers overboard.

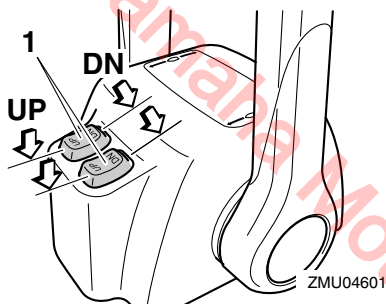

ZMU04601

1. Power trim and tilt switch

To raise the bow (trim-out), press the switch “UP” (up).

To lower the bow (trim-in), press the switch “DN” (down).

Make test runs with the trim set to different angles to find the position that works best for your boat and operating conditions.

EMU27913

Adjusting boat trim

When the boat is on plane, a bow-up attitude results in less drag, greater stability and efficiency. This is generally when the keel line of the boat is up about 3 to 5 degrees. With the bow up, the boat may have a greater tendency to steer to one side or the other. Compensate for this as you steer. When the bow of the boat is down, it is easier to accelerate from a standing start onto plane.

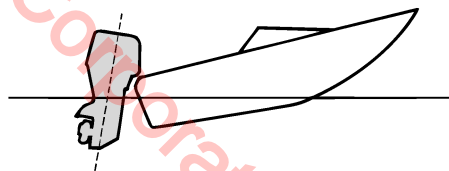

ZMU01785

Bow Down

Too much trim-in causes the boat to “plow” through the water, decreasing fuel economy and making it hard to increase speed. Operating with excessive trim-in at higher speeds also makes the boat unstable. Resistance at the bow is greatly increased, heightening the danger of “bow steering” and making operation difficult and dangerous.

Operation

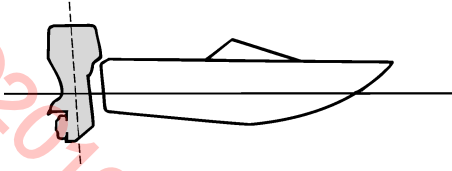

ZMU01786

TIP:

Depending on the type of boat, the outboard motor trim angle may have little effect on the trim of the boat when operating.

EMU27948

Tilting up and down

If the engine will be stopped for some time or if the boat is moored in shallows, the outboard motor should be tilted up to protect the propeller and lower case from damage by collision with obstructions, and also to reduce salt corrosion.

EWM01544

WARNING

Make sure that all people are clear of the outboard motor when tilting the outboard motor up and down. Body parts can be crushed between the outboard motor and the clamp bracket when the outboard motor is trimmed or tilted.

ECM00993

NOTICE

● Before tilting the outboard motor, follow the procedure under “Stopping engine” in this chapter. Never tilt the outboard motor while the engine is running. Severe damage from overheating can result.

● To prevent the cooling water passages from becoming frozen when the ambient temperature is 5°C (41°F) or below, tilt the outboard motor up after it has been stopped 30 seconds or more.

EMU42683

Procedure for tilting up

1. Place the remote control lever in neutral.

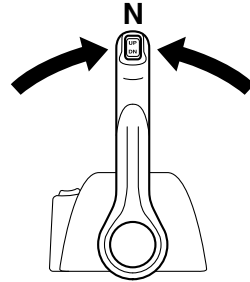

ZMU07396

2. Press the power trim and tilt switch “UP” (up) until the outboard motor has tilted up completely.

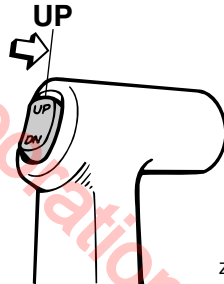

ZMU04194

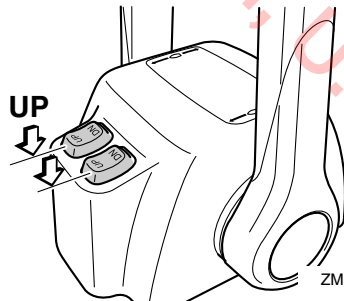

ZMU04602

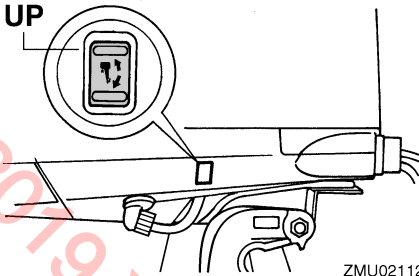

3. Pull the tilt support lever toward you to support the engine. **WARNING!** After tilting the outboard motor, be sure to support it with the tilt support knob or tilt support lever. Otherwise the outboard motor could fall back down suddenly if oil in the power trim and tilt unit or in the power tilt unit loses pressure. [EWM00263] **NOTICE:** Do not use the tilt support lever or knob when trailering the boat. The outboard motor could shake loose from the tilt support and fall. If the motor cannot be trailered in the normal running position, use an additional support device to secure it in the tilt position. For more detailed information, see page 64. [ECM01642]

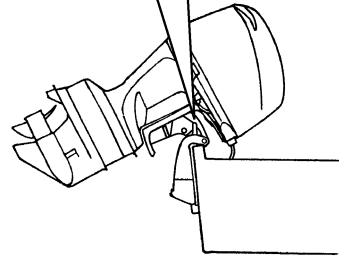
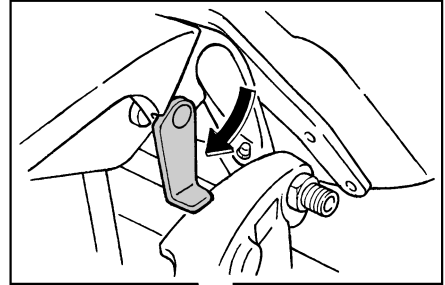

ZMU05352

4. Once the outboard motor is supported with the tilt support lever, press the power trim and tilt switch “DN” (down) to retract the trim rods. **NOTICE:** Make sure that the trim rods retract completely during mooring. This protects the rods from marine growth and corrosion, which could damage the power trim and tilt mechanism. [ECM00253]

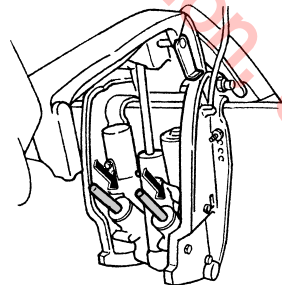

ZMU07399

Operation

EMU42702

Procedure for tilting down

1. Push the power trim and tilt switch “UP” (up) until the outboard motor is supported by the tilt rod and the tilt support lever becomes free.
2. Release the tilt support lever.

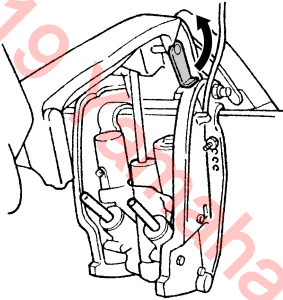

ZMU06019

3. Push the power trim and tilt switch “DN” (down) to lower the outboard motor to the desired position.

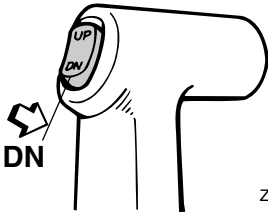

ZMU04196

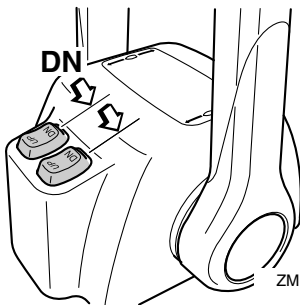

ZMU04603

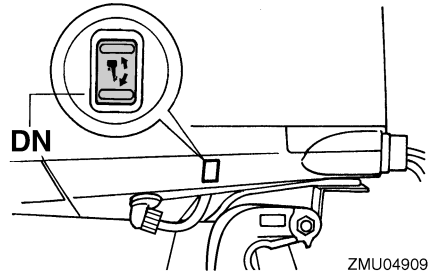

ZMU04909

EMU28063

Shallow water

EMU32872

Power trim and tilt models

The outboard motor can be tilted up partially to allow operation in shallow water.

ECM01491

NOTICE

- If the engine speed is suddenly increased when the outboard motor is partially tilted up, the power trim and tilt unit could be damaged.
- Do not tilt the outboard motor up so that the cooling water inlet on the lower unit is above the surface of the water when setting up for and cruising in shallow water. Otherwise severe damage from overheating can result.

EMU32923

Procedure for power trim and tilt models

1. Place the remote control lever in neutral.

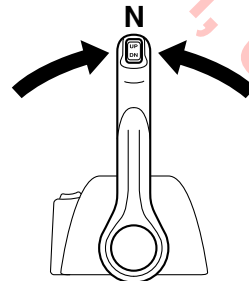

ZMU04588

2. Slightly tilt the outboard motor up to the desired position using the power trim and tilt switch. **WARNING! Using the power trim and tilt switch on the bottom cowling while the boat is moving or engine is on could increase the risk of falling overboard and could distract the operator, increasing the risk of collision with another boat or an obstacle.** [EWM01851]

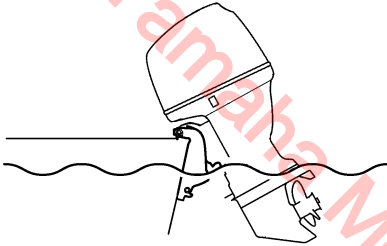

ZMU05173

3. To return the outboard motor to the normal running position, press the power trim and tilt switch and slowly tilt the outboard motor down.

EMU41371

Operating in other conditions

Operating in salt water

After operating in saltwater, brackish water, or water high in other minerals, flush the cooling system with fresh water to minimize corrosion and clogging of the cooling water passages with deposits. Also, rinse the exterior of the outboard motor with fresh water.

Operating in water containing mud, sand, silt, debris, or vegetation

Mud, sand, silt, debris, and vegetation in the water may restrict water flow into the cooling water inlet covers or clog internal water passages. Check and clean the cooling water inlet covers frequently when operating in these conditions. Flush the engine with clean, fresh water after use in these environments. Con-

sult your dealer if normal water flow can not be restored by cleaning the cooling water inlet covers or flushing with fresh water.

Maintenance

EMU41532

Transporting and storing outboard motor

EWM02641

WARNING

- **USE CARE** when transporting fuel tank, whether in a boat or car.
- **DO NOT** fill fuel container to maximum capacity. Gasoline will expand considerably as it warms up and can build up pressure in the fuel container. This can cause fuel leakage and a potential fire hazard.
- Leaking fuel is a fire hazard. Tighten securely the fuel valve when transporting and storing the outboard motor.
- Never get under the outboard motor while it is tilted. Severe injury could occur if the outboard motor accidentally falls.
- Do not use the tilt support lever or knob when trailering the boat. The outboard motor could shake loose from the tilt support and fall. If the outboard motor cannot be trailered in the normal running position, use an additional support device to secure it in the tilt position.

Leaking fuel is a fire hazard. When trailering the boat, close the fuel valve to prevent fuel from leaking.

The outboard motor should be transported and stored in the normal running position. If there is insufficient road clearance in this position, then trailer the outboard motor in the tilt position using a motor support device such as a transom saver bar. Consult your Yamaha dealer for further details.

When the outboard motor is tilted prolonged time for mooring or trailering the boat, close the fuel valve.

EMU30722

Storing outboard motor

When storing your Yamaha outboard motor for prolonged periods of time (2 months or longer), several important procedures must be performed to prevent excessive damage. It is advisable to have your outboard motor serviced by an authorized Yamaha dealer prior to storage. However, you, the owner, with a minimum of tools, can perform the following procedures.

ECM01361

NOTICE

- To prevent problems which can be caused by oil entering the cylinder from the sump, keep the outboard motor in the attitude shown when transporting and storing it. Do not store or transport the outboard motor on its side (not upright).
- Do not place the outboard motor on its side before the cooling water has drained from it completely, otherwise water may enter the cylinder through the exhaust port and cause engine trouble.
- Store the outboard motor in a dry, well-ventilated place, not in direct sunlight.

TIP:

The last time you use your Yamaha outboard motor before storing it for a prolonged period, add one ounce of “Yamalube Fuel Stabilizer & Conditioner Plus” to each gallon of fuel in the fuel tank.

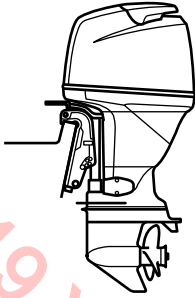

ZMU04261

EMU41382

Conditioning and stabilizing gasoline

When preparing to store a boat for extended periods (2 months or longer) it is best to completely remove all gasoline from the boat's fuel tank(s). If it is not possible to remove the gasoline, add one ounce of "Yamalube Fuel Stabilizer & Conditioner Plus" to each gallon of gasoline in a full tank of gasoline to provide fuel stability and corrosion protection.

TIP:

Do not fill the fuel tank(s) to the point of overflowing. Approximately 7/8 full will allow enough space in the fuel tank to prevent gasoline purging from the fuel tank vent due to expansion with temperature changes.

Do not cap the fuel tank vent. Excessive pressure could damage the boat and motor's fuel systems.

A partially filled fuel tank, less than 7/8 full but not completely empty, is not recommended. Air space above the gasoline allows air movement which can bring in water through condensation as the air temperature changes.

Condensation inside the fuel tank can cause corrosion problems and phase separation of gasoline containing ethanol.

Consult your Yamaha dealer concerning preventative measures that may work best for the gasoline and environmental conditions in your area.

EMU28306

Procedure

EMU30747

Flushing with the flushing attachment (F200, LF200, F225)

1. Wash the outboard motor body using fresh water. **NOTICE: Do not spray water into the air intake.** [ECM01841] For further information, see page 67.
2. Fill the fuel tank with fresh fuel and add one ounce of "Yamalube Fuel Stabilizer & Conditioner Plus" to each gallon of fuel.

TIP:

The use of "Yamalube Fuel Stabilizer & Conditioner Plus" eliminates the need to drain the fuel system. Consult your Yamaha dealer or other qualified mechanic if the fuel system is to be drained instead.

3. Remove the top cowling and propeller.
4. Install the flushing attachment over the cooling water inlet. **NOTICE: Do not run the engine without supplying it with cooling water. Either the engine water pump will be damaged or the engine will be damaged from overheating. Before starting the engine, be sure to supply water to the cooling water passages. Avoid running the outboard motor at high speed while on the flushing attachment, otherwise overheating could occur.** [ECM02001]

Maintenance

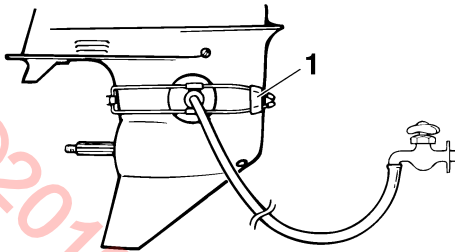

ZMU01830

1. Flushing attachment
5. Cooling system flushing is essential to prevent the cooling system from clogging up with salt, sand, or dirt. In addition, fogging/lubricating of the engine is mandatory to prevent excessive engine damage due to rust. Perform the flushing and fogging at the same time.
WARNING! Do not touch or remove electrical parts when starting or during operation. Keep hands, hair, and clothes away from the flywheel and other rotating parts while the engine is running. [EWM00092]

TIP:

- When using the flushing attachment, maintain adequate water pressure so that there is a steady flow of water from the cooling water pilot hole.
 - If the overheat alert device is activated, turn the engine off, and consult your Yamaha dealer.
6. Run the engine at a fast idle for a few minutes in neutral position while supplying fresh water.
 7. Just prior to turning off the engine, quickly spray “Yamaha Stor-Rite Engine Fogging Oil” alternately into the intake silencer or the fogging hole of the silencer

er cover, if equipped. When properly done, the engine will smoke excessively and almost stall.

8. Remove the flushing attachment and wipe off any excess water.
9. Install the top cowling and propeller.
10. Drain the cooling water completely out of the motor. Clean the body thoroughly.

TIP:

A flushing attachment is available from your Yamaha dealer.

EMU28403

Lubrication

1. Install the spark plug(s) and torque to proper specification. For information on spark plug installation, see page 74.
2. Change the gear oil. For instructions, see page 82. Inspect the oil for the presence of water that indicates a leaky seal. Seal replacement should be performed by an authorized Yamaha dealer prior to use.
3. Grease all grease fittings. For further details, see page 72.

TIP:

For long-term storage, fogging the engine with oil is recommended. Contact your Yamaha dealer for information about fogging oil and procedures for your engine.

EMU30268

Cleaning and anticorrosion measures

1. Wash down the exterior of the outboard motor with fresh water and dry off completely. **NOTICE: Do not spray water into the air intake.** [ECM01841] For further information, see page 67.
2. Spray the outboard motor exterior with “Yamaha Silicone Protectant”. **NOTICE: Do not spray when the engine is running. Also, do not spray near the silencer or into the engine. Otherwise the engine could be damaged.** [ECM01403]

3. Wax the cowling with a non-abrasive wax such as “Yamaha Silicone Wax”.

EMU42551

Flushing power unit

Perform this procedure right after operation for the most thorough flushing.

ECM01531

NOTICE

Do not perform this procedure while the engine is running. The water pump may be damaged and severe damage from overheating can result.

1. After shutting off the engine, unscrew the garden hose connector from the fitting on the bottom cowling.

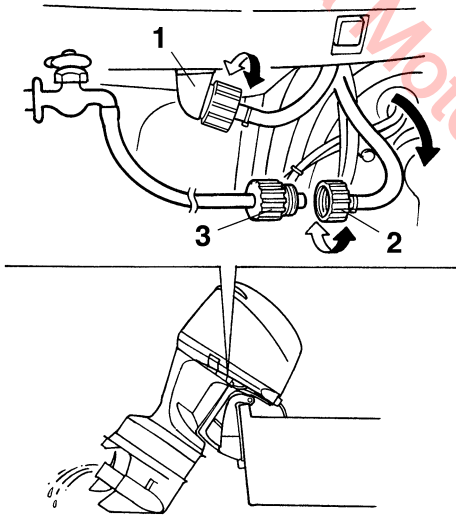

ZMU02136

1. Fitting
 2. Garden hose connector
 3. Garden hose adapter
2. Screw the garden hose adapter onto a garden hose, which is connected to a fresh water supply, and then connect it to the garden hose connector.

3. With the engine off, turn on the water tap and let the water flush through the cooling passages for about 15 minutes. Turn off the water and disconnect the garden hose adapter from the garden hose connector.

4. Reinstall the garden hose connector onto the fitting on the bottom cowling. Tighten the connector securely. **NOTICE: Do not leave the garden hose connector loose on the bottom cowling fitting or let the hose hang free during normal operation. Water will leak out of the connector instead of cooling the engine, which can cause serious overheating. Be sure the connector is tightened securely on the fitting after flushing the engine.** [ECM00542]

TIP:

- When flushing the engine with the boat in the water, tilting up the outboard motor until it is completely out of the water will achieve better results.
- F200, LF200, F225: For cooling system flushing instructions, see page 64.

EMU44341

Cleaning the outboard motor

When cleaning the outboard motor, the top cowling must be installed.

1. Wash the exterior of the outboard motor using fresh water. **NOTICE: Do not spray water into the air intake.** [ECM01841]

Maintenance

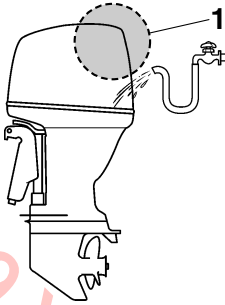

ZMU07861

1. Air intake
2. Drain the cooling water completely out of the outboard motor. Clean the body thoroughly.

EMU28462

Checking painted surface of outboard motor

Check the outboard motor for scratches, nicks, or flaking paint. Areas with damaged paint are more likely to corrode. If necessary, clean and paint the areas. A touch-up paint is available from your Yamaha dealer.

EMU2848C

Periodic maintenance

EWM01872



These procedures require mechanical skills, tools, and supplies. If you do not have the proper skills, tools, or supplies to perform a maintenance procedure, have a Yamaha dealer or other qualified mechanic do the work.

The procedures involve disassembling the motor and exposing dangerous parts. To reduce the risk of injury from moving, hot, or electrical parts:

- **Turn off the engine and keep the key(s) and engine shut-off cord (lanyard) with you when you perform maintenance unless otherwise specified.**

- **The power trim and tilt switches operate even when the ignition key is off. Keep people away from the switches whenever working around the motor. When the motor is tilted, keep away from the area under it or between it and the clamp bracket. Be sure no one is in this area before operating the power trim and tilt mechanism.**

- **Allow the engine to cool before handling hot parts or fluids.**

- **Always completely reassemble the motor before operation.**

Maintenance, replacement, or repair of the emission control devices and systems may be performed by any marine engine repair establishment or individual. All warranty repairs, however, including those to the emission control system, must be performed by an authorized Yamaha marine dealership.

A service manual is available for purchase through your Yamaha dealer for owners who have the mechanical skills, tools, and other equipment necessary to perform maintenance not covered by this owner's manual.

EMU28512

Replacement parts

If replacement parts are necessary, use only genuine Yamaha parts or parts of equivalent design and quality. Any part of inferior quality may malfunction, and the resulting loss of control could endanger the operator and passengers. Yamaha genuine parts and accessories are available from your Yamaha dealer.

EMU35522

Maintenance interval guidelines

The service intervals provided in the Maintenance Chart were developed based upon "typical" use that includes operating at varied speeds, with sufficient time for engine warm up and cool-down, a medium to light load,

and an average cruising speed near the 3000 to 4000 rpm range. As with any engine, however, if your normal operating conditions are different, you should consider service more often than shown, especially how often you change your engine oil and gear oil. Examples might include extended wide-open-throttle use or long periods of trolling or

idling, carrying heavy loads, or frequent starting and stopping or shifting. More frequent maintenance will often pay off many times over in increased engine life and greater owner satisfaction. Consult your Yamaha dealer for additional maintenance recommendations.

EMU34448

Maintenance chart 1

TIP:

- Refer to the sections in this chapter for explanations of each owner-specific action.
- The maintenance cycle on these charts assume usage of 100 hours per year and regular flushing of the cooling water passages. Maintenance frequency should be adjusted when operating the engine under adverse conditions such as extended trolling.
- Disassembly or repairs may be necessary depending on the outcome of maintenance checks.
- Expendable or consumable parts and lubricants will lose their effectiveness over time and through normal usage regardless of the warranty period.
- When operating in salt water, muddy, other turbid (cloudy), acidic water, the engine should be flushed with clean water after each use.

The “●” symbol indicates the check-ups which you may carry out yourself.

The “○” symbol indicates work to be carried out by your Yamaha dealer.

Item	Actions	Initial	Every		
		20 hours (3 months)	100 hours (1 year)	300 hours (3 years)	500 hours (5 years)
Anode(s) (external)	Inspection or replacement as necessary		●/○		
Anode(s) (cylinder head, thermostat cover)	Inspection or replacement as necessary		○		
Anodes (exhaust cover, cooling water passage cover, Rectifier Regulator cover)	Replacement				○
Battery (electrolyte level, terminal)	Inspection	●/○	●/○		
Battery (electrolyte level, terminal)	Fill, charging or replacing as necessary		○		
Cooling water leakage	Inspection or replacement as necessary	○	○		
Cowling lock lever	Inspection		●/○		

Maintenance

Item	Actions	Initial	Every			
		20 hours (3 months)	100 hours (1 year)	300 hours (3 years)	500 hours (5 years)	
Engine starting condition/noise	Inspection	●/○	●/○			
Engine idle speed/noise	Inspection	●/○	●/○			
Engine oil	Replacement	●/○	●/○			
Engine oil filter (cartridge)	Replacement		●/○			
Fuel filter (can be disassembled)	Inspection or replacement as necessary	●/○	●/○			
Fuel line (High pressure)	Inspection	●	●			
Fuel line (High pressure)	Inspection or replacement as necessary	○	○			
Fuel line (Low pressure)	Inspection	●	●			
Fuel line (Low pressure)	Inspection or replacement as necessary	○	○			
Fuel pump	Inspection or replacement as necessary			○		
Fuel/engine oil leakage	Inspection	○	○			
Gear oil	Replacement	●/○	●/○			
Greasing points	Greasing	●/○	●/○			
Clamp bracket bolt (through tube)	Inspection and greasing		○			
Impeller/water pump housing	Inspection or replacement as necessary		○			
Impeller/water pump housing	Replacement			○		
OCV (Oil Control Valve) filter	Replacement				○	
Power trim and tilt unit	Inspection	●/○	●/○			
Propeller/propeller nut/cotter pin	Inspection or replacement as necessary	●/○	●/○			
PCV (Pressure Control Valve)	Inspection or replacement as necessary		○			
Shift link/shift cable	Inspection, adjustment or replacement as necessary	○	○			
Spark plug(s)	Inspection or replacement as necessary		●/○			
Ignition coils/ignition coil leads	Inspection or replacement as necessary	○	○			

Maintenance

Item	Actions	Initial	Every			
		20 hours (3 months)	100 hours (1 year)	300 hours (3 years)	500 hours (5 years)	
Water from the cooling water pilot hole	Inspection	●/○	●/○			
Throttle link/throttle cable/throttle pick-up timing	Inspection, adjustment or replacement as necessary	○	○			
Thermostat	Inspection or replacement as necessary		○			
Timing belt	Inspection or replacement as necessary		○			
Valve clearance	Inspection and adjustment					○
Cooling water inlet	Inspection	●/○	●/○			
Main switch/stop switch/choke switch	Inspection or replacement as necessary	○	○			
Wire harness connections/wire coupler connections	Inspection or replacement as necessary	○	○			
(Yamaha) Meter/gauge	Inspection	○	○			

EMU34452

Maintenance chart 2

Item	Actions	Every
		1000 hours
Exhaust guide/exhaust manifold	Inspection or replacement as necessary	○
Timing belt	Replacement	○

Maintenance

EMU28935

Greasing

Yamaha marine grease (Water resistant grease)

F200A, LF200A, F225A

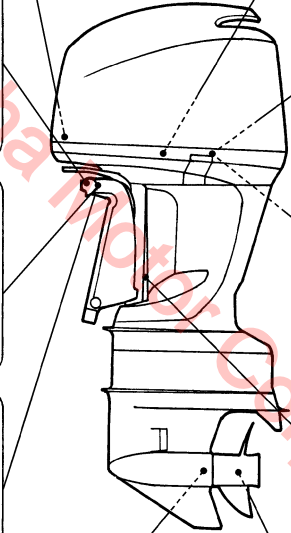
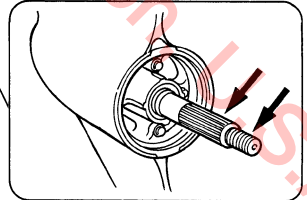
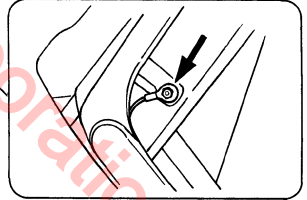
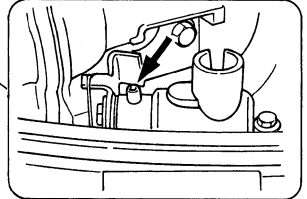
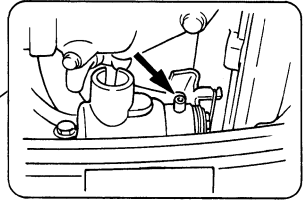
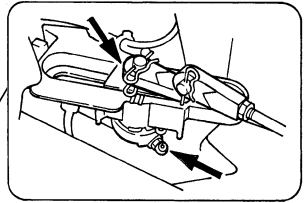
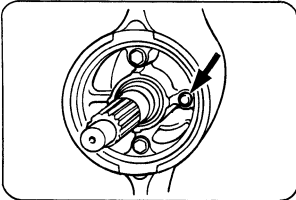
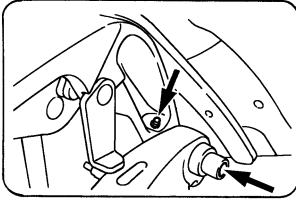
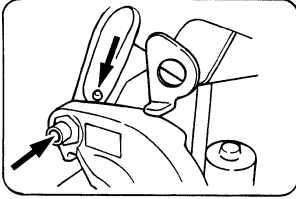
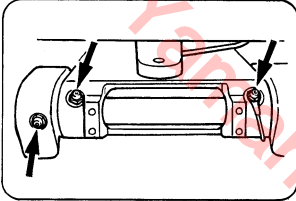
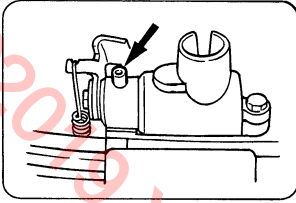

ZMU02138

F250A, LF250A

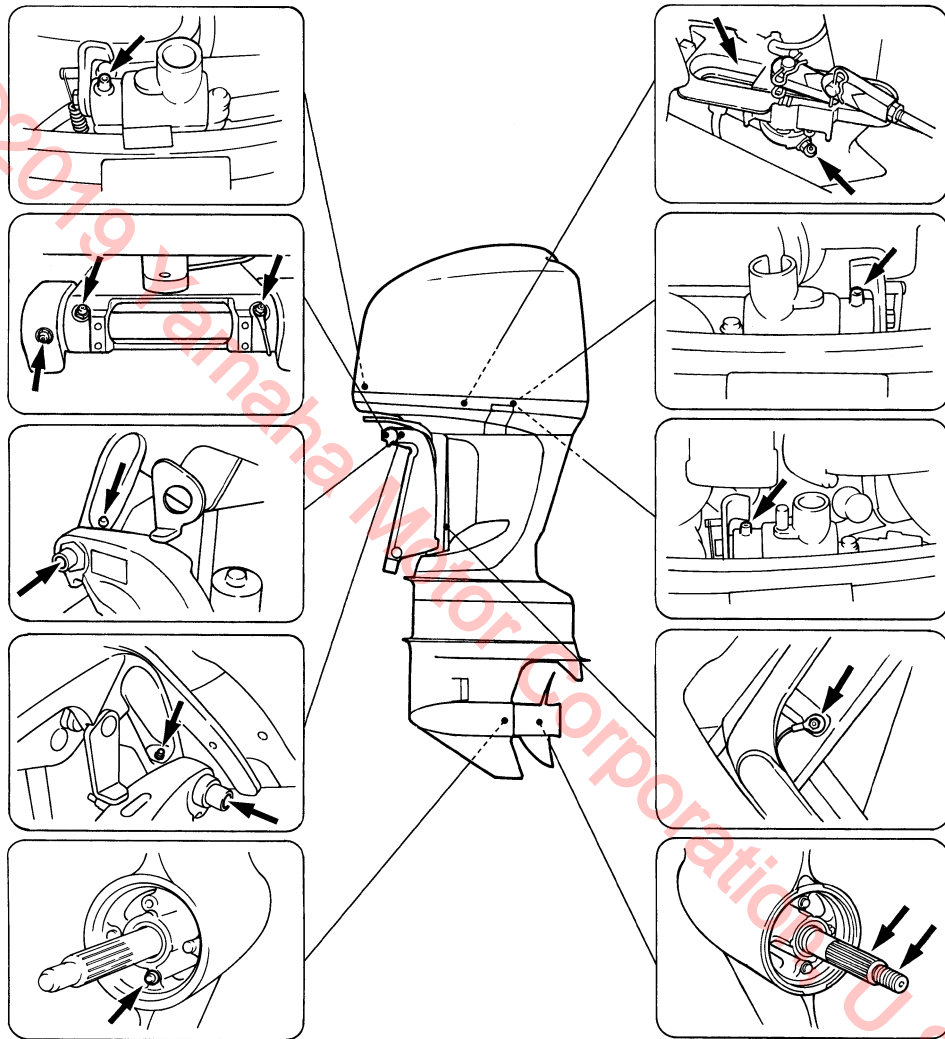

ZMU05149

Maintenance

EMU3077A

Cleaning and adjusting spark plug

The spark plug is an important engine component and is easy to inspect. The condition of the spark plug can indicate something about the condition of the engine. For example, if the center electrode porcelain is very white, this could indicate an intake air leak or carburetion problem in that cylinder. Do not attempt to diagnose any problems yourself. Instead, take the outboard motor to a Yamaha dealer. You should periodically remove and inspect the spark plug because heat and deposits will cause the spark plug to slowly break down and erode.

1. Remove the bolts to remove the ECM (Electronic control module) cover.

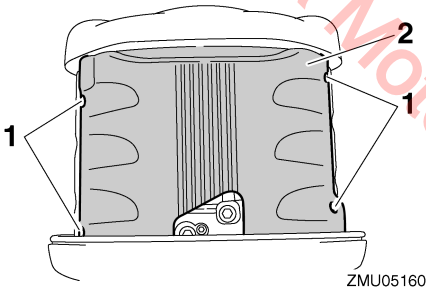

1. Bolt
 2. ECM (Electronic Control Module) cover
2. Remove the bolts that are securing the ignition coil, and then remove the ignition coil. Do not use any tools to remove or install the ignition coil, otherwise the ignition coil coupler may get damaged.

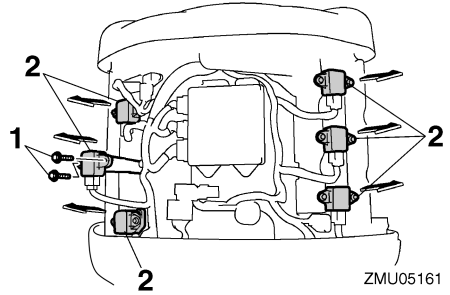

1. Bolt
 2. Ignition coil
3. Remove the spark plug. If electrode erosion becomes excessive, or if carbon and other deposits are excessive, you should replace the spark plug with another of the correct type. **WARNING! When removing or installing a spark plug, be careful not to damage the insulator. A damaged insulator could allow external sparks, which could lead to explosion or fire.** [EWM00562]

Standard spark plug:
LFR6A-11

4. Be sure to use the specified spark plug, otherwise the engine may not operate properly. Before fitting the spark plug, measure the electrode gap with a wire thickness gauge; replace it if out of specification.

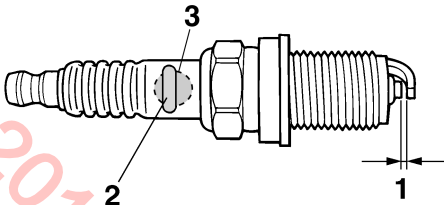

ZMU01797

1. Spark plug gap
2. Spark plug part number
3. Spark plug I.D. mark (NGK)

Spark plug gap:

1.0–1.1 mm (0.039–0.043 in)

5. When fitting the plug, wipe off any dirt from the threads, and then screw it in to the correct torque.

Spark plug torque:

25 Nm (2.55 kgf-m, 18.4 ft-lb)

TIP:

If a torque-wrench is not available when you are reinstalling a spark plug, a good estimate of the correct torque is 1/12 turn past finger-tight. When you are installing a new spark plug, a good estimate of the correct torque is 1/2 to 2/3 turn past finger-tight.

6. Install the ignition coil and tighten the bolts.

Bolt tightening torque:

7 Nm (0.71 kgf-m, 5.2 ft-lb)

7. Install the ECM (Electronic control module) cover and tighten the bolts.

Bolt tightening torque:

8 Nm (0.82 kgf-m, 5.9 ft-lb)

EMU29045

Inspecting idle speed

EWM00452

WARNING

- Do not touch or remove electrical parts when starting or during operation.
- Keep hands, hair, and clothes away from the flywheel and other rotating parts while the engine is running.

ECM00491

NOTICE

This procedure must be performed while the outboard motor is in the water. A flushing attachment or test tank can be used.

If the boat is not equipped with a tachometer for the outboard motor, use a diagnostic tachometer for this procedure. Results may vary depending on whether testing is conducted with the flushing attachment, in a test tank, or with the outboard motor in the water.

1. Start the engine and allow it to warm up fully in neutral until it is running smoothly.
2. Once the engine has warmed up, verify whether the idle speed is set to specification. For idle speed specifications, see page 13. If you have difficulty verifying the idle speed, or the idle speed requires adjustment, consult a Yamaha dealer or other qualified mechanic.

EMU37487

Changing engine oil

EWM00761

WARNING

- Avoid draining the engine oil immediately after stopping the engine. The oil is hot and should be handled with care to avoid burns.
- Be sure the outboard motor is securely fastened to the transom or a stable stand.

Maintenance

ECM01711

NOTICE

Change the engine oil after the first 20 hours of operation or 3 months, and every 100 hours or at 1-year intervals thereafter. Otherwise the engine will wear quickly.

To prevent spilling oil where it could cause damage to nature, it is strongly recommended that you use an oil changer to change the engine oil. If an oil changer is not available, drain the engine oil by removing the drain screw. If you are not familiar with the procedure for changing the engine oil, consult your Yamaha dealer.

Changing the engine oil using an oil changer (recommended)

1. Put the outboard motor in an upright position (not tilted). **NOTICE: If the outboard motor is not level, the oil level indicated on the oil dipstick may not be accurate.** [ECM01862]

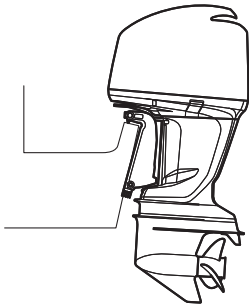

ZMU07953

2. Start the engine. Warm it up and keep the idle speed for 5-10 minutes.
3. Stop the engine and leave it for 5-10 minutes.
4. Remove the top cowling.
5. Remove the oil filler cap. Pull out the dipstick and use the oil changer to extract the oil completely.

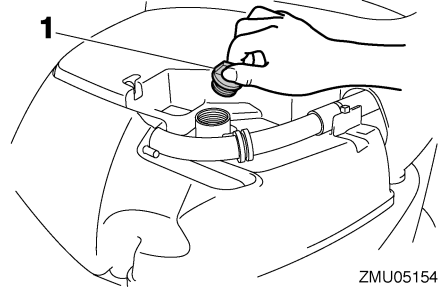

ZMU05154

1. Oil filler cap

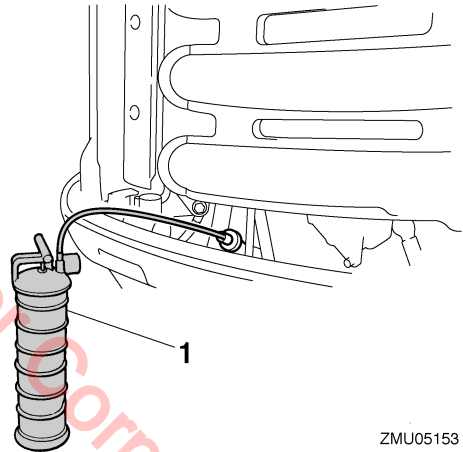

ZMU05153

1. Oil changer

6. Add the correct amount of oil through the filler hole. Put back the filler cap and the dipstick. **NOTICE: Overfilling the oil could cause leakage or damage. If the oil level is above the upper level mark, drain until the level meets the specified capacity.** [ECM01851]

Recommended engine oil:

YAMALUBE 4M FC-W or 4-stroke outboard motor oil
Engine oil quantity (without oil filter replacement):
4.5 L (4.76 US qt, 3.96 Imp.qt)
Engine oil quantity (with oil filter replacement):
4.7 L (4.97 US qt, 4.14 Imp.qt)

7. Leave the outboard motor for 5-10 minutes.
8. Remove oil dipstick and wipe it clean.
9. Insert the dipstick and remove it again. Be sure to completely insert the dipstick into the dipstick guide, otherwise the oil level measurement will be incorrect.
10. Recheck the oil level using the dipstick to be sure the level falls between the upper and lower marks. Consult your Yamaha dealer if the oil level is out of specified level.

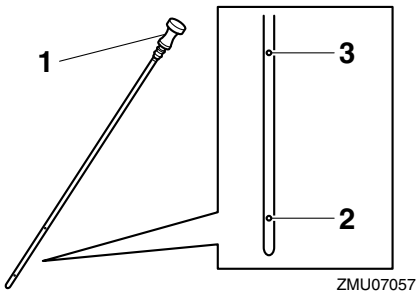

1. Oil dipstick
2. Lower mark
3. Upper mark

11. Start the engine and make sure that the low oil pressure-alert indicator remains off. Also, make sure that there are no oil leaks. **NOTICE: If the low oil pressure-alert indicator comes on or if there are oil leaks, stop the engine and find the cause. Continued operation with a problem could cause severe engine**

damage. Consult your Yamaha dealer if the problem cannot be located and corrected. [ECM01623]

12. Install the top cowling.
13. Dispose of used oil according to local regulations.

TIP:

- For more information on the disposal of used oil, consult your Yamaha dealer.
- Change the oil more often when operating the engine under adverse conditions such as extended trolling.

Changing the engine oil by draining the oil

1. Put the outboard motor in an upright position (not tilted). **NOTICE: If the outboard motor is not level, the oil level indicated on the oil dipstick may not be accurate.** [ECM01862]

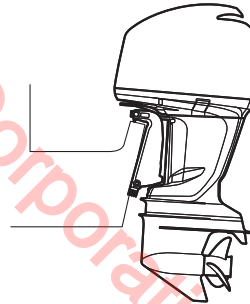

2. Start the engine. Warm it up and keep the idle speed for 5-10 minutes.
3. Stop the engine and leave it for 5-10 minutes.
4. Remove the top cowling and oil filler cap.

Maintenance

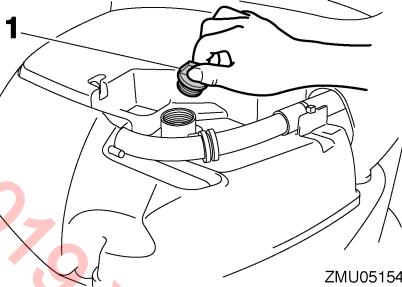

ZMU05154

1. Oil filler cap

- Remove the bolts to remove the apron from the starboard side.

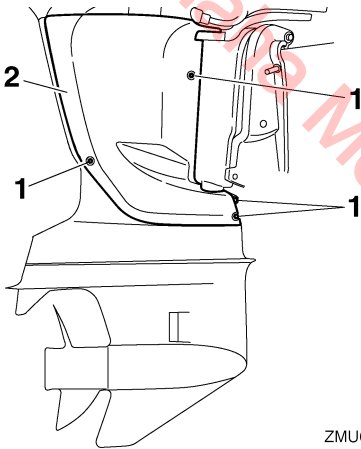

ZMU05155

1. Bolt
2. Apron

- Prepare a suitable container that holds a larger amount than the engine oil capacity. Remove the drain screw and gasket while holding the container under the drain hole. Let the oil drain completely. Wipe up any spilled oil immediately.

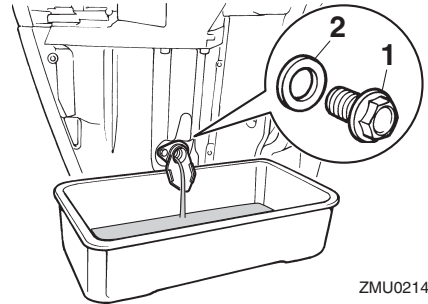

ZMU02145

1. Drain screw
2. Gasket

TIP:

If the oil does not drain easily, change the tilt angle or turn the outboard motor to port and starboard to drain the oil.

- Put a new gasket on the drain screw. Apply a light coat of oil to the gasket and install the drain screw.

Drain screw tightening torque:
27 Nm (2.75 kgf-m, 19.9 ft-lb)

TIP:

If a torque wrench is not available when you are installing the drain screw, finger tighten the screw just until the gasket comes into contact with the surface of the drain hole. Then tighten 1/4 to 1/2 turn more. Tighten the drain screw to the correct torque with a torque wrench as soon as possible.

- Add the correct amount of oil through the filler hole. Put back the filler cap and the dipstick. **NOTICE: Overfilling the oil could cause leakage or damage. If the oil level is above the upper level mark, drain until the level meets the specified capacity.** [ECM01851]

Recommended engine oil:

YAMALUBE 4M FC-W or 4-stroke outboard motor oil

Engine oil quantity (without oil filter replacement):

4.5 L (4.76 US qt, 3.96 Imp.qt)

Engine oil quantity (with oil filter replacement):

4.7 L (4.97 US qt, 4.14 Imp.qt)

9. Leave the outboard motor for 5-10 minutes.
10. Remove the oil dipstick and wipe it clean.
11. Insert the dipstick and remove it again. Be sure to completely insert the dipstick into the dipstick guide, otherwise the oil level measurement will be incorrect.
12. Recheck the oil level using the dipstick to be sure the level falls between the upper and lower marks. Consult your Yamaha dealer if the oil level is out of specified level.

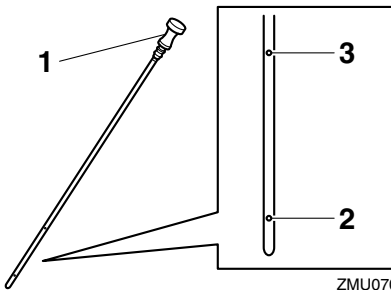

1. Oil dipstick
2. Lower mark
3. Upper mark

13. Start the engine and make sure that the low oil pressure-alert indicator remains off. Also, make sure that there are no oil leaks. **NOTICE: If the low oil pressure-alert indicator comes on or if there are oil leaks, stop the engine and find the cause. Continued operation with a**

problem could cause severe engine damage. Consult your Yamaha dealer if the problem cannot be located and corrected. [ECM01623]

14. Apply LOCTITE 572 to the threads of the bolts, and then install the apron.

TIP:

LOCTITE 572 is used as a sealant.

15. Install the top cowling.
16. Dispose of used oil according to local regulations.

TIP:

- For more information on the disposal of used oil, consult your Yamaha dealer.
- Change the oil more often when operating the engine under adverse conditions such as extended trolling.

EMU29115

Inspecting wiring and connectors

- Inspect that each connector is engaged securely.
- Inspect that each ground lead is properly secured.

Maintenance

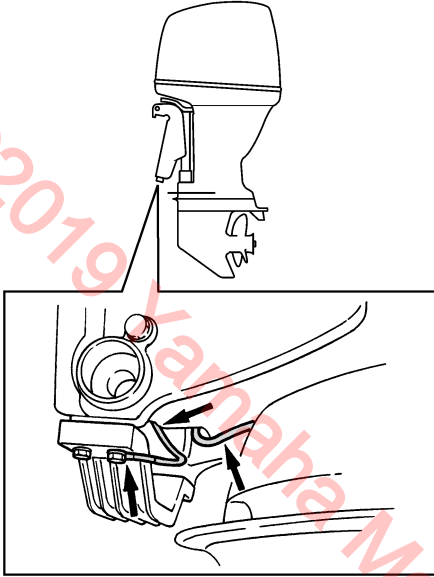

ZMU02146

EMU32113

Checking propeller

EWM01882

WARNING

You could be seriously injured if the engine accidentally starts when you are near the propeller. Before inspecting, removing, or installing the propeller, place the shift control in neutral, turn the main switch to "OFF" (off) and remove the key, and remove the clip from the engine shut-off switch. Turn off the battery cut-off switch if your boat has one.

Do not use your hand to hold the propeller when loosening or tightening the propeller nut. Put a wood block between the anti-cavitation plate and the propeller to prevent the propeller from turning.

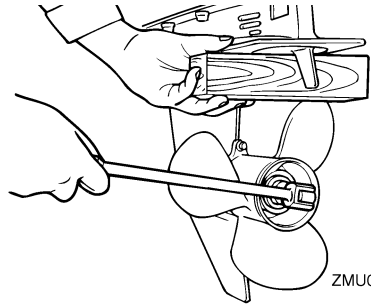

ZMU01802

Checkpoints

- Check each of the propeller blades for erosion from cavitation or ventilation, or other damage.
- Check the propeller shaft for damage.
- Check the splines for wear or damage.
- Check for fish line tangled around the propeller shaft.

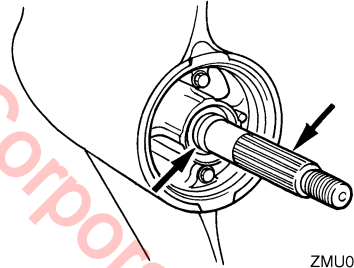

ZMU02147

- Check the propeller shaft oil seal for damage.

EMU42632

Removing propeller

1. Straighten the cotter pin and pull it out using a pair of pliers.
2. Remove the propeller nut, washer, and spacer. **WARNING! Do not use your hand to hold the propeller when loosening the propeller nut.** [EWM01891]

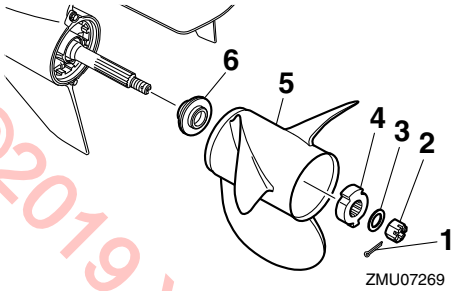

1. Cotter pin
2. Propeller nut
3. Washer
4. Spacer
5. Propeller
6. Thrust washer

3. Remove the propeller, spacer (if equipped), and thrust washer.

EMU41981

Installing propeller

EWM00771

WARNING

On counter rotation models, be sure to use a propeller intended for counterclockwise rotation. These propellers are identified with the letter "L" after the size indication on the propeller. Otherwise the boat could move in the opposite direction from that expected.

ECM00502

NOTICE

Make sure to use a new cotter pin and bend the ends over securely. Otherwise, the propeller could come off during operation and be lost.

1. Apply Yamalube Marine Grease to the propeller shaft.
2. Install the thrust washer and propeller on the propeller shaft. **NOTICE: Make sure to install the thrust washer before in-**

stalling the propeller. Otherwise, the lower case and propeller boss could be damaged. [ECM01882]

3. Install the spacer, washer, and propeller nut. Tighten the propeller nut to the specified torque.

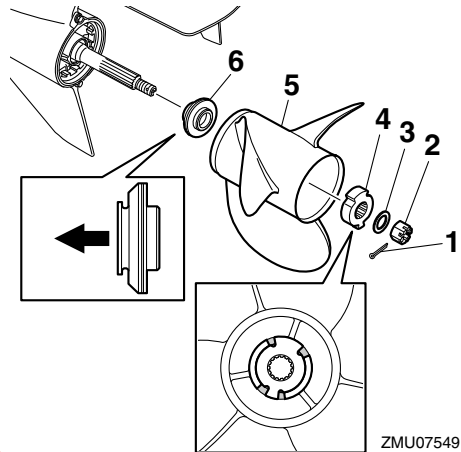

1. Cotter pin
2. Propeller nut
3. Washer
4. Spacer
5. Propeller
6. Thrust washer

Propeller nut tightening torque:
54 Nm (5.51 kgf-m, 39.8 ft-lb)

TIP:

Make sure to align the protrusions on the spacer with the cutout areas of the propeller.

4. Align the propeller nut slot with the propeller shaft hole. Insert a new cotter pin in the hole and bend the cotter pin ends.

NOTICE: Do not reuse the cotter pin. Otherwise, the propeller can come off during operation. [ECM01892]

Maintenance

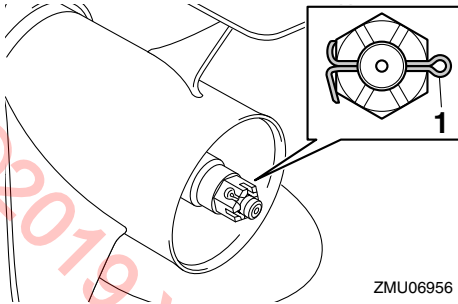

1. Cotter pin

TIP:

If the propeller nut slot does not align with the propeller shaft hole after tightening the propeller nut to the specified torque, tighten the nut further to align the slot with the hole.

EMU42573

Changing gear oil

F200, LF200, F225

EWM00801

WARNING

- Be sure the outboard motor is securely fastened to the transom or a stable stand. You could be severely injured if the outboard motor falls on you.
- Never get under the lower unit while it is tilted, even when the tilt support lever or knob is locked. Severe injury could occur if the outboard motor accidentally falls.

1. Tilt the outboard motor so that the gear oil drain screw is at the lowest point possible.
2. Place a suitable container under the gear case.
3. Remove the gear oil drain screw and gasket. **NOTICE: If there is an excessive quantity of metal particles on the magnetic gear oil drain screw, this can indicate lower unit problem. Consult your Yamaha dealer.** [ECM01901]

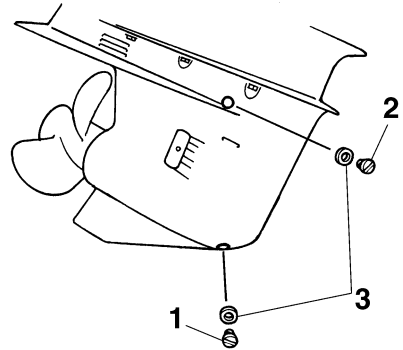

1. Gear oil drain screw
2. Oil level plug
3. Gasket

TIP:

- If a magnetic gear oil drain screw is equipped, remove all metal particles from the screw before installing it.
 - Always use new gaskets. Do not reuse the removed gaskets.
4. Remove the oil level plug and gasket to allow the oil to drain completely. **NOTICE: Check the used gear oil after it has been drained. If the gear oil is milky or contains water or a large amount of metal particles, the gear case may be damaged. Have a Yamaha dealer check and repair the outboard motor.** [ECM00714]

TIP:

For disposal of used oil, consult your Yamaha dealer.

5. Put the outboard motor in a vertical position. Using a flexible or pressurized filling device, inject the gear oil into the gear oil drain screw hole.

Recommended gear oil:

Yamalube Marine Gearcase Lube or
Hypoid gear oil

Recommended gear oil grade:

SAE 90 API GL-4

Gear oil quantity:

F200A 1.150 L (1.216 US qt,
1.012 Imp.qt)

F225A 1.150 L (1.216 US qt,
1.012 Imp.qt)

LF200A 1.000 L (1.057 US qt,
0.880 Imp.qt)

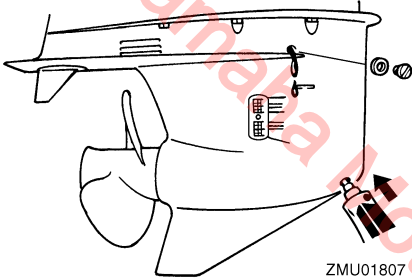

- Put a new gasket on the oil level plug. When the oil begins to flow out of the oil level plug hole, insert and tighten the oil level plug.

Tightening torque:

9 Nm (0.92 kgf-m, 6.6 ft-lb)

- Put a new gasket on the gear oil drain screw. Insert and tighten the gear oil drain screw.

Tightening torque:

9 Nm (0.92 kgf-m, 6.6 ft-lb)

F250, LF250

EWM00801

WARNING

- Be sure the outboard motor is securely fastened to the transom or a stable stand. You could be severely injured if the outboard motor falls on you.

- Never get under the lower unit while it is tilted, even when the tilt support lever or knob is locked. Severe injury could occur if the outboard motor accidentally falls.

- Tilt the outboard motor so that the gear oil drain screw is at the lowest point possible.
- Place a suitable container under the gear case.
- Remove the cooling water inlet covers on both sides of the gear case. Be careful not to lose the bolt and nut.
- Remove the gear oil drain screw and gasket. The screw is magnetic so a small quantity of metal particles on the end of the screw is normal. Simply remove them. **NOTICE: If there is an excessive quantity of metal particles on the magnetic gear oil drain screw, this can indicate lower unit problem. Consult your Yamaha dealer.** [ECM01901]

Maintenance

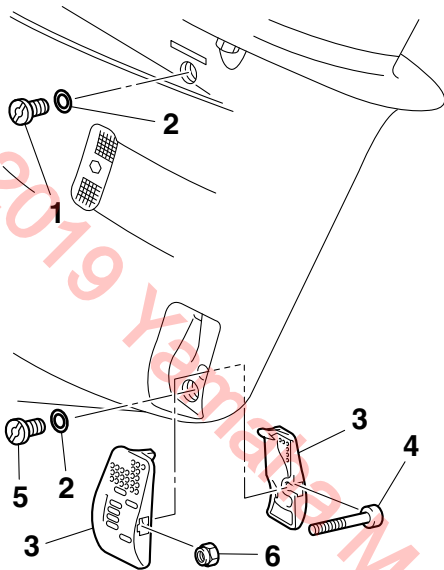

ZMU05487

1. Oil level plug
2. Gasket
3. Cooling water inlet cover
4. Bolt
5. Gear oil drain screw
6. Nut

5. Remove the oil level plug and gasket to allow the oil to drain completely.
NOTICE: Check the used gear oil after it has been drained. If the gear oil is milky or contains water or a large amount of metal particles, the gear case may be damaged. Have a Yamaha dealer check and repair the outboard motor. [ECM00714]

TIP:

For disposal of used oil, consult your Yamaha dealer.

6. Put the outboard motor in a vertical position. Using a flexible or pressurized filling device, inject the gear oil into the gear oil drain screw hole.

Recommended gear oil:

Yamalube Marine Gearcase Lube or Hypoid gear oil

Recommended gear oil grade:

SAE 90 API GL-4

Gear oil quantity:

F250A 0.920 L (0.972 US qt, 0.810 Imp.qt)

LF250A 0.800 L (0.846 US qt, 0.704 Imp.qt)

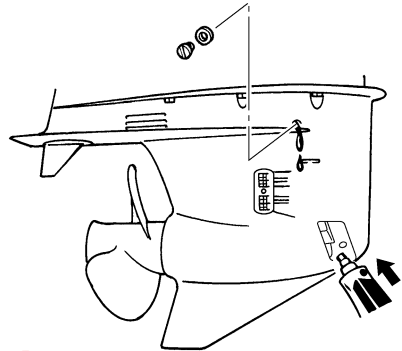

ZMU05488

7. Put a new gasket on the oil level plug. When the oil begins to flow out of the oil level plug hole, insert and tighten the oil level plug.

Tightening torque:

9 Nm (0.92 kgf-m, 6.6 ft-lb)

8. Put a new gasket on the gear oil drain screw. Insert and tighten the gear oil drain screw.

Tightening torque:

9 Nm (0.92 kgf-m, 6.6 ft-lb)

9. Securely install the cooling water inlet covers on both sides of the gear case using the bolt and nut removed earlier.

Tightening torque:

2.0 Nm (0.20 kgf-m, 1.5 ft-lb)

EMU29317

Inspecting and replacing anode(s)

Yamaha outboard motors are protected from corrosion by sacrificial anodes. Inspect the external anodes periodically. Remove scales from the surfaces of the anodes. Consult a Yamaha dealer for replacement of external anodes.

ECM00721

NOTICE

Do not paint anodes, as this would render them ineffective.

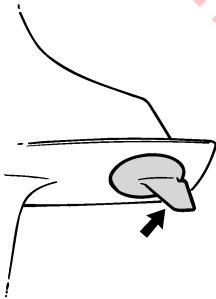

ZMU01808

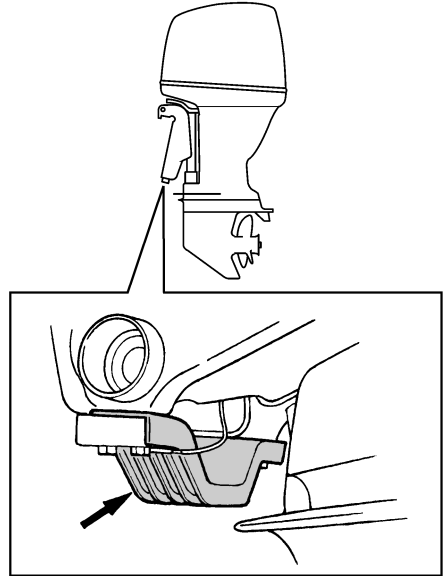

ZMU05353

TIP:

Inspect ground leads attached to external anodes on equipped models. Consult a Yamaha dealer for inspection and replacement of internal anodes attached to the power unit.

EMU29324

Checking battery (for electric start models)

EWM01903

! WARNING

Battery electrolyte is poisonous and caustic, and batteries generate explosive hydrogen gas. When working near the battery:

- Wear protective eye gear and rubber gloves.
- Do not smoke or bring any other source of ignition near the battery.

Maintenance

The procedure for checking the battery varies for different batteries. This procedure contains typical checks that apply to many batteries, but you should always refer to the battery manufacturer's instructions.

ECM01921

NOTICE

A poorly maintained battery will quickly deteriorate.

1. Check the electrolyte level.

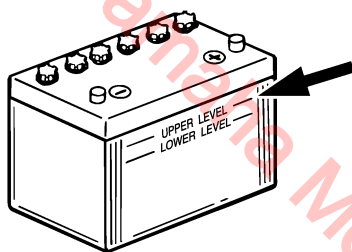

ZMU01810

2. Check the battery's charge. If your boat is equipped with the digital speedometer, the voltmeter and low battery alert functions will help you monitor the battery's charge. If the battery needs charging, consult your Yamaha dealer.
3. Check the battery connections. They should be clean, secure, and covered by an insulating cover. **WARNING! Bad connections can produce shorting or arcing and cause an explosion.** [EWM01913]

EMU35496

Connecting the battery

EWM00573

WARNING

Mount the battery holder securely in a dry, well-ventilated, vibration-free location in the boat. Install a fully charged battery in the holder.

ECM01125

NOTICE

Do not reverse the battery cables. Otherwise, the electrical parts could be damaged.

1. Make sure the main switch (on applicable models) is "OFF" (off) before working on the battery.
2. Connect the red battery cable to the POSITIVE (+) terminal first. Then connect the black battery cable to the NEGATIVE (-) terminal.

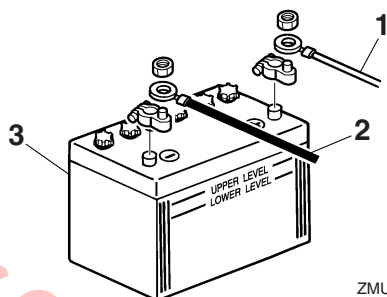

ZMU01811

1. Red cable
 2. Black cable
 3. Battery
3. The electrical contacts of the battery and cables must be clean and properly connected, or the battery will not start the engine.

Connecting an accessory battery (optional)

If connecting an accessory battery, consult your Yamaha dealer about correct wiring. For the fuse size, see ABYC (E-11).

Single engine

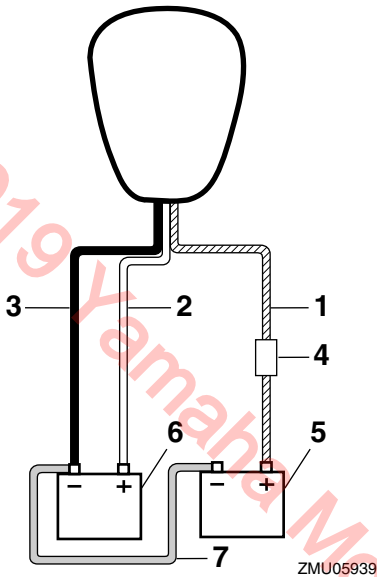

1. Isolator leads with circuit protection
2. Red cable
3. Black cable
4. Fuse
5. Battery for accessories
6. Battery for starting
7. Negative connecting cable

Twin engines

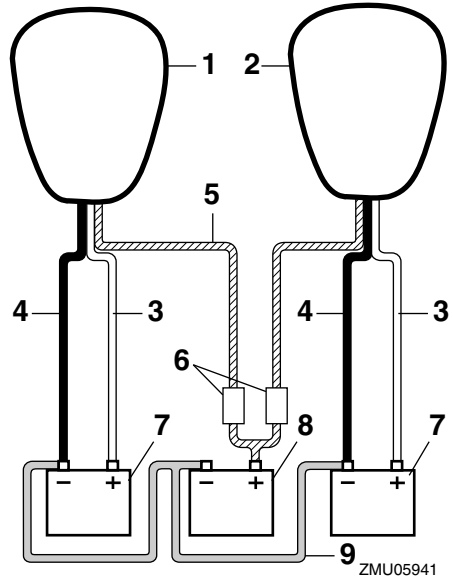

1. Starboard side engine
2. Port side engine
3. Red cable
4. Black cable
5. Isolator leads with circuit protection
6. Fuse
7. Battery for starting
8. Battery for accessories
9. Negative connecting cable

EMU29372

Disconnecting the battery

1. Turn off the battery cut-off switch (if equipped) and main switch. **NOTICE: If they are left on, the electrical system can be damaged.** [ECM01931]
2. Disconnect the negative cable(s) from the negative (-) terminal. **NOTICE: Always disconnect all negative (-) cables first to avoid a short circuit and damage to the electrical system.** [ECM01941]
3. Disconnect the positive cable(s) and remove the battery from the boat.

Maintenance

4. Clean, maintain, and store the battery according to the manufacturer's instructions.

©2019 Yamaha Motor Corporation, U.S.A.

EMU29428

Troubleshooting

A problem in the fuel, compression, or ignition systems can cause poor starting, loss of power, or other problems. This section describes basic checks and possible remedies, and covers all Yamaha outboard motors. Therefore some items may not apply to your model.

If your outboard motor requires repair, bring it to your Yamaha dealer.

If the engine trouble-alert indicator is flashing, consult your Yamaha dealer.

Starter will not operate.

Q. Is battery capacity weak or low?

A. Check battery condition. Use battery of recommended capacity.

Q. Are battery connections loose or corroded?

A. Tighten battery cables and clean battery terminals.

Q. Is fuse for electric start relay or electric circuit blown?

A. Check for cause of electric overload and repair. Replace fuse with one of correct amperage.

Q. Are starter components faulty?

A. Have serviced by a Yamaha dealer.

Q. Is shift lever in gear?

A. Shift to neutral.

Engine will not start (starter operates).

Q. Is fuel tank empty?

A. Fill tank with clean, fresh fuel.

Q. Is fuel contaminated or stale?

A. Fill tank with clean, fresh fuel.

Q. Is fuel filter clogged?

A. Clean or replace filter.

Q. Is starting procedure incorrect?

A. See page 54.

Q. Has fuel pump malfunctioned?

A. Have serviced by a Yamaha dealer.

Q. Are spark plug(s) fouled or of incorrect type?

A. Inspect spark plug(s). Clean or replace with recommended type.

Q. Are spark plug cap(s) fitted incorrectly?

A. Check and re-fit cap(s).

Q. Is ignition wiring damaged or poorly connected?

A. Check wires for wear or breaks. Tighten all loose connections. Replace worn or broken wires.

Q. Are ignition parts faulty?

A. Have serviced by a Yamaha dealer.

Q. Is engine shut-off cord (lanyard) not attached?

A. Attach cord.

Q. Are engine inner parts damaged?

A. Have serviced by a Yamaha dealer.

Engine idles irregularly or stalls.

Q. Are spark plug(s) fouled or of incorrect type?

A. Inspect spark plug(s). Clean or replace with recommended type.

Trouble Recovery

Q. Is fuel system obstructed?

A. Check for pinched or kinked fuel line or other obstructions in fuel system.

Q. Is fuel contaminated or stale?

A. Fill tank with clean, fresh fuel.

Q. Is fuel filter clogged?

A. Clean or replace filter.

Q. Have ignition parts failed?

A. Have serviced by a Yamaha dealer.

Q. Has alert system activated?

A. Find and correct cause of alert.

Q. Is spark plug gap incorrect?

A. Inspect and adjust as specified.

Q. Is ignition wiring damaged or poorly connected?

A. Check wires for wear or breaks. Tighten all loose connections. Replace worn or broken wires.

Q. Is specified engine oil not being used?

A. Check and replace oil as specified.

Q. Is thermostat faulty or clogged?

A. Have serviced by a Yamaha dealer.

Q. Are carburetor adjustments incorrect?

A. Have serviced by a Yamaha dealer.

Q. Is fuel pump damaged?

A. Have serviced by a Yamaha dealer.

Q. Is air vent screw on fuel tank closed?

A. Open air vent screw.

Q. Is choke knob pulled out?

A. Return to home position.

Q. Is motor angle too high?

A. Return to normal operating position.

Q. Is carburetor clogged?

A. Have serviced by a Yamaha dealer.

Q. Is fuel joint connection incorrect?

A. Connect correctly.

Q. Is throttle valve adjustment incorrect?

A. Have serviced by a Yamaha dealer.

Q. Is battery cable disconnected?

A. Connect securely.

Alert buzzer sounds or indicator lights.

Q. Is cooling system clogged?

A. Check water intake for restriction.

Q. Is engine oil level low?

A. Fill oil tank with specified engine oil.

Q. Is heat range of spark plug incorrect?

A. Inspect spark plug and replace it with recommended type.

Q. Is specified engine oil not being used?

A. Check and replace oil with specified type.

Q. Is engine oil contaminated or deteriorated?

A. Replace oil with fresh, specified type.

Q. Is oil filter clogged?

A. Have serviced by a Yamaha dealer.

Q. Has oil feed/injection pump malfunctioned?

Trouble Recovery

A. Have serviced by a Yamaha dealer.

Q. Is load on boat improperly distributed?

A. Distribute load to place boat on an even plane.

Q. Is water pump or thermostat faulty?

A. Have serviced by a Yamaha dealer.

Q. Is there excess water in fuel filter cup?

A. Drain filter cup.

Engine power loss.

Q. Is propeller damaged?

A. Have propeller repaired or replaced.

Q. Is propeller pitch or diameter incorrect?

A. Install correct propeller to operate outboard at its recommended speed (r/min) range.

Q. Is trim angle incorrect?

A. Adjust trim angle to achieve most efficient operation.

Q. Is motor mounted at incorrect height on transom?

A. Have motor adjusted to proper transom height.

Q. Has alert system activated?

A. Find and correct cause of alert.

Q. Is boat bottom fouled with marine growth?

A. Clean boat bottom.

Q. Are spark plug(s) fouled or of incorrect type?

A. Inspect spark plug(s). Clean or replace with recommended type.

Q. Are weeds or other foreign matter tangled on gear housing?

A. Remove foreign matter and clean lower unit.

Q. Is fuel system obstructed?

A. Check for pinched or kinked fuel line or other obstructions in fuel system.

Q. Is fuel filter clogged?

A. Clean or replace filter.

Q. Is fuel contaminated or stale?

A. Fill tank with clean, fresh fuel.

Q. Is spark plug gap incorrect?

A. Inspect and adjust as specified.

Q. Is ignition wiring damaged or poorly connected?

A. Check wires for wear or breaks. Tighten all loose connections. Replace worn or broken wires.

Q. Have electrical parts failed?

A. Have serviced by a Yamaha dealer.

Q. Is specified fuel not being used?

A. Replace fuel with specified type.

Q. Is specified engine oil not being used?

A. Check and replace oil with specified type.

Q. Is thermostat faulty or clogged?

A. Have serviced by a Yamaha dealer.

Q. Is air vent screw closed?

A. Open the air vent screw.

Q. Is fuel pump damaged?

Trouble Recovery

A. Have serviced by a Yamaha dealer.

Q. Is fuel joint connection incorrect?

A. Connect correctly.

Q. Is heat range of spark plug incorrect?

A. Inspect spark plug and replace it with recommended type.

Q. Is high pressure fuel pump drive belt broken?

A. Have serviced by a Yamaha dealer.

Q. Is engine not responding properly to shift lever position?

A. Have serviced by a Yamaha dealer.

Engine vibrates excessively.

Q. Is propeller damaged?

A. Have propeller repaired or replaced.

Q. Is propeller shaft damaged?

A. Have serviced by a Yamaha dealer.

Q. Are weeds or other foreign matter tangled on propeller?

A. Remove and clean propeller.

Q. Is motor mounting bolt loose?

A. Tighten bolt.

Q. Is steering pivot loose or damaged?

A. Tighten or have serviced by a Yamaha dealer.

EMU29434

Temporary action in emergency

EMU29442

Impact damage

EWM00871



The outboard motor can be seriously damaged by a collision while operating or trailering. Damage could make the outboard motor unsafe to operate.

If the outboard motor hits an object in the water, follow the procedure below.



1. Stop the engine immediately.
2. Check the control system and all components for damage. Also, check the boat for damage.
3. Whether damage is found or not, return to the nearest harbor slowly and carefully.
4. Have a Yamaha dealer check the outboard motor before operating it again.

EMU29454

Running single engine (twin engines)

When using only one engine in an emergency, be sure to keep the unused one tilted up and operate the other engine at low speed.

ECM00371

NOTICE

If the boat is operated with one engine in the water but not running, water may run into the exhaust pipe due to wave action, causing engine trouble.

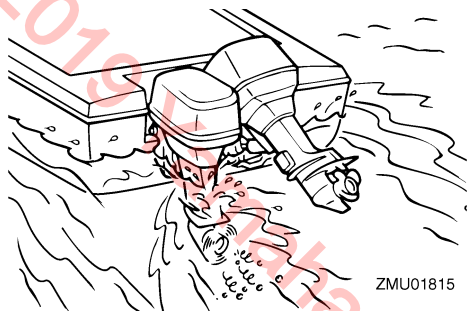

TIP:

When you are maneuvering at low speed, such as near a dock, it is recommended that both engines be running with one in neutral gear if possible.

EMU29475

Replacing fuse

If a fuse has blown, remove the electrical cover, open the fuse holder and remove the fuse with a fuse puller (if equipped). Replace it with a spare one of the proper amperage.

EWM00632

WARNING

Substituting an incorrect fuse or a piece of wire could allow excessive current flow. This could cause electric system damage and a fire hazard.

Consult your Yamaha dealer if the new fuse immediately blows again.

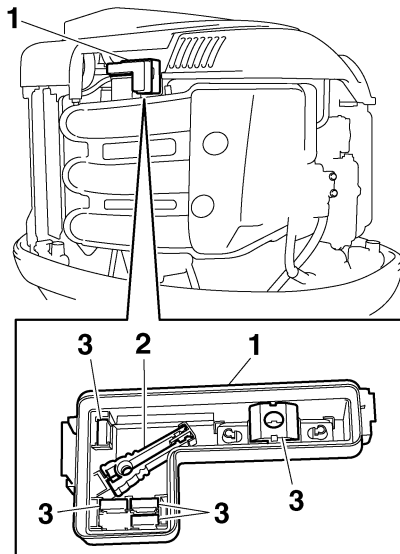

1. Electrical cover
2. Fuse puller
3. Spare fuse (10 A, 15 A, 20 A, 30 A, 60 A)

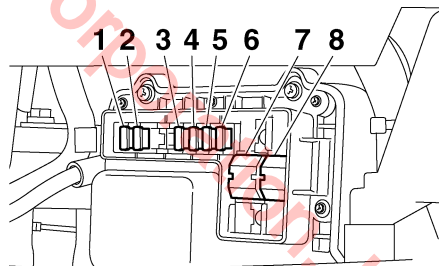

1. Electric throttle valve / ECM (Electronic control module) fuse (10 A)
2. Ignition coil / Fuel injector / Variable camshaft timing / ECM (Electronic Control Module) fuse (30 A)
3. Main switch / PTT switch fuse (20 A)
4. Starter relay fuse (30 A)
5. Fuel feed pump fuse (10 A)
6. Fuel pump fuse (15 A)

Trouble Recovery

7. Engine main fuse (60 A)
8. Isolator fuse (60 A)

EMU29526

Power trim and tilt will not operate

If the engine cannot be tilted up or down with the power trim and tilt because of a discharged battery or a failure with the power trim and tilt unit, the engine can be tilted manually.

1. Loosen the manual valve screw by turning it counterclockwise until it stops.

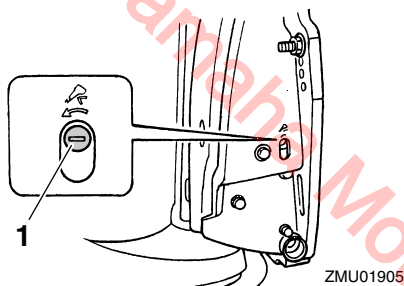

1. Manual valve screw
2. Put the engine in the desired position, then tighten the manual valve screw by turning it clockwise.

EMU37572

Water separator-alert indicator blinks while cruising

EWM01501

WARNING

Gasoline is highly flammable, and its vapors are flammable and explosive.

- Do not perform this procedure on a hot or running engine. Allow the engine to cool.
- There will be fuel in the fuel filter. Keep away from sparks, cigarettes, flames or other sources of ignition.
- This procedure will allow some fuel to spill. Catch fuel in a rag. Wipe up any spilled fuel immediately.

- The fuel filter must be reassembled carefully with the O-ring, filter cup, and hoses in place. Improper assembly or replacement could result in a fuel leak, which could result in a fire or explosion hazard.

If the water separator-alert indicator on the 6Y8 Multifunction tachometer blinks, perform the following procedure.

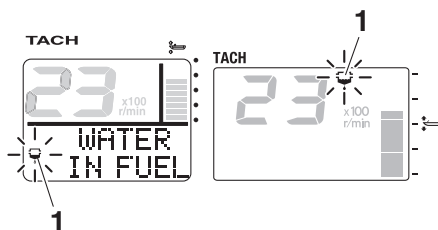

ZMU05442

1. Water separator-alert indicator
1. Stop the engine.
2. Remove the top cowling.
3. Remove the holder.

Trouble Recovery

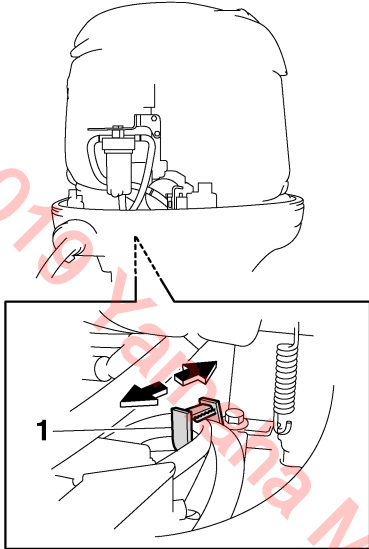

ZMU05443

1. Holder
4. Disconnect the water detection switch coupler. **NOTICE: Be careful not to get any water on the water detection switch coupler, otherwise a malfunction could occur.** [ECM01951]

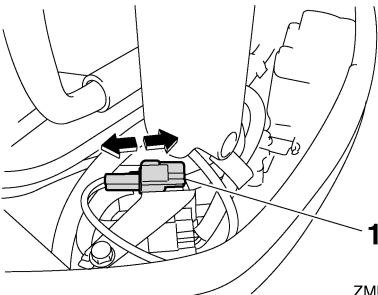

ZMU05444

1. Water detection switch coupler
5. Unscrew the filter cup from the filter housing. **NOTICE: Be careful not to twist the water detection switch lead when unscrewing the filter cup.** [ECM01961]

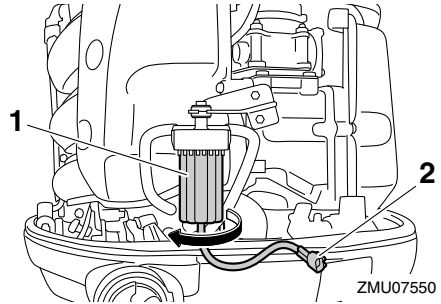

1. Filter cup
2. Water detection switch lead
6. Drain the water in the filter cup by soaking it up with a rag.
7. Firmly screw the filter cup onto the filter housing. **NOTICE: Be careful not to twist the water detection switch lead when screwing the filter cup onto the filter housing.** [ECM01971]
8. Connect the water detection switch coupler securely until a click is heard.

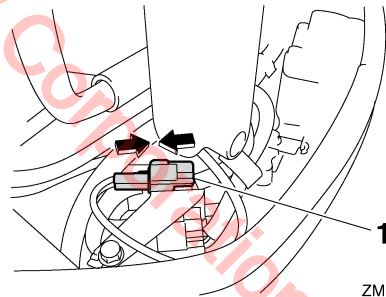

ZMU05446

1. Water detection switch coupler
9. Fasten the water detection switch lead with the holder.

Trouble Recovery

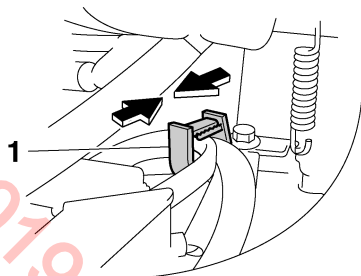

ZMU05447

1. Holder
10. Install the top cowling.
11. Start the engine and make sure that the water separator-alert indicator remains off. Have a Yamaha dealer inspect the outboard motor after returning to port.

EMU33502

Treatment of submerged motor

If the outboard motor is submerged, immediately take it to a Yamaha dealer. Otherwise some corrosion may begin almost immediately. **NOTICE: Do not attempt to run the outboard motor until it has been completely inspected.** [ECM00402]

Consumer information (For North America)

EMU29837

YAMAHA FOUR-STROKE OUTBOARD MOTOR THREE-YEAR LIMITED WARRANTY

Yamaha Motor Corporation, U.S.A. and Yamaha Motor Canada Ltd. ("Yamaha") hereby warrant that new Yamaha four-stroke outboard motors will be free from defects in material and workmanship for the period of time stated herein, subject to certain stated limitations.

PERIOD OF WARRANTY. Any new Yamaha four-stroke outboard motor purchased from an authorized Yamaha dealer in the customer's country of residence (United States or Canada) and registered with Yamaha will be warranted against defects in material or workmanship, subject to exclusions noted herein, for the following applicable period determined by type of use:

- Pleasure use – three (3) years from the date of purchase.
 - Commercial application – one (1) year from the date of purchase. A commercial application is defined as any use of the outboard motor to generate income (excluding tournament fishing) or support business operations in any way during the warranty period, without regard to the type or percentage of commercial use. Yamaha reserves the right to modify incorrect registration data and reduce the warranty period to reflect commercial use.
 - Yamaha peripheral equipment included with the motor, such as gauges, fuel tanks, and hoses, remote control boxes, and wiring external from the motor unit, will be warranted for one (1) year from the date of purchase for either pleasure or commercial use.
- Replacement parts used in warranty repairs will be warranted for the balance of the applicable warranty period.

The second and third year of warranty (if applicable) shall be limited to covering the cost of parts and labor for major components only. The major components covered are:

Power Unit Section

- Power Head
- Intake Manifold
- Carburetor Assembly and its Related Components
- Fuel Injection System and its Related Components
- Fuel and Oil Pump Assemblies
- Ignition System (Standard and Microcomputer)

Lower Unit Section Bracket Section

- Exhaust System
- Bracket System
- Upper Casing
- Power Trim and Tilt Assembly
- Lower Unit Assembly

WARRANTY REGISTRATION. To be eligible for warranty coverage, the outboard motor must be registered with Yamaha in the country of residence. Warranty registration can be accomplished by any authorized Yamaha Outboard Motor Dealer.

OBTAINING REPAIRS UNDER WARRANTY. During the period of warranty, any authorized Yamaha Outboard Motor Dealer in the country of residence will, free of charge, repair or replace, at Yamaha's option, any parts adjudged defective by Yamaha due to faulty workmanship or material from the factory. All replaced parts will become the property of Yamaha. If the customer is temporarily using a U.S.-registered outboard motor in Canada, or a Canada-registered outboard motor in the United States, and it needs warranty repairs, the owner should contact a nearby authorized Yamaha Outboard Motor Dealer for assistance. The local dealer will contact Yamaha on the owner's behalf so that needed repairs can be made as quickly as possible.

CUSTOMER'S RESPONSIBILITY. Under the terms of this warranty, the customer will be responsible for ensuring that the outboard motor is properly operated, maintained, and stored as specified in the applicable Owner's Manual. The owner of the outboard motor shall give notice to an authorized Yamaha Outboard Motor Dealer of any and all apparent defects within ten (10) days of discovery and make the motor available at that time for inspection and repairs at the dealer's place of business.

ZMU07048

Consumer information (For North America)

GENERAL EXCLUSIONS FROM WARRANTY. This warranty will not cover the repair of damage if the damage is a result of abuse or neglect of the product. Examples of abuse and neglect include, but are not limited to:

1. Racing or competition use, modification of original parts, abnormal strain.
2. Lack of proper maintenance and off season storage as described in the Owner's Manual; installation of parts or accessories that are not equivalent in design and quality to genuine Yamaha parts.
3. Operation of the motor at an rpm other than specified, use of lubricants or oils that are not suitable for outboard motor use.
4. Damage as a result of accidents, collisions, contact with foreign materials, or submersion.
5. Growth of marine organism on motor surfaces.
6. Normal deterioration.

SPECIFIC PARTS EXCLUDED FROM WARRANTY. Parts replaced due to normal wear or routine maintenance such as oil, spark plugs, shear pins, propellers, hubs, fuel and oil filters, brushes for the starter motor and power tilt motor, water pump impellers, and anodes, are not covered by warranty. Charges for removal of the motor from a boat and transporting the motor to and from an authorized Yamaha Outboard Motor Dealer are excluded from warranty coverage.

Specific parts excluded from the second and third year of warranty (if applicable) are:

- Top and Bottom Cowling
- Electric Components (other than ignition system)
- Rubber Components (such as hoses, tubes, rubber seals, fittings, and clamps)

EMISSION CONTROL WARRANTY (United States only). Yamaha warrants to the ultimate purchaser and any subsequent owner, that the emission control components on this engine are designed, built and equipped so as to conform at the time of sale with applicable regulations under section 213 of the Clean Air Act and that this engine is covered against defects in materials and workmanship which cause said engine to fail to conform with applicable exhaust emission regulations for five (5) years from the date of purchase or 175 hours of operation, whichever comes first. Evaporative components (e.g., hoses, fuel tank, fuel cap) are two (2) years from the date of purchase. Some states have different emission control warranty provisions. As these vary from state to state, consult your Yamaha dealer or contact Yamaha Customer Relations at 1-866-894-1626 for more information.

TRANSFER OF WARRANTY Transfer of the warranty from the original purchaser to any subsequent purchaser is possible by having the motor inspected by an authorized Yamaha Outboard Motor Dealer and requesting the dealer to submit a change of registration to Yamaha within ten (10) days of the transfer.

YAMAHA MAKES NO OTHER WARRANTY OF ANY KIND, EXPRESSED OR IMPLIED. ALL IMPLIED WARRANTIES OF MERCHANTABILITY AND FITNESS FOR A PARTICULAR PURPOSE WHICH EXCEED THE OBLIGATIONS AND TIME LIMITS STATED IN THIS WARRANTY ARE HEREBY DISCLAIMED BY YAMAHA AND EXCLUDED FROM THIS WARRANTY. SOME STATES/PROVINCES DO NOT ALLOW LIMITATIONS ON HOW LONG AN IMPLIED WARRANTY LASTS, SO THE ABOVE LIMITATIONS MAY NOT APPLY TO YOU. ALSO EXCLUDED FROM THIS WARRANTY ARE ANY INCIDENTAL OR CONSEQUENTIAL DAMAGES INCLUDING LOSS OF USE. SOME STATES/PROVINCES DO NOT ALLOW THE EXCLUSION OR LIMITATION OF INCIDENTAL OR CONSEQUENTIAL DAMAGES, SO THE ABOVE EXCLUSION MAY NOT APPLY TO YOU.

THIS WARRANTY GIVES YOU SPECIFIC LEGAL RIGHTS, AND YOU MAY ALSO HAVE OTHER RIGHTS WHICH VARY FROM STATE TO STATE/PROVINCE TO PROVINCE.

ZMU07047

Consumer information (For North America)

EMU29846

IMPORTANT WARRANTY INFORMATION IF YOU USE YOUR YAMAHA OUTSIDE THE U.S.A. OR CANADA

Welcome to the Yamaha Family!

Congratulations on the purchase of your new Yamaha products. Yamaha is committed to exceptional customer satisfaction and we want your ownership experience to be a satisfying one. Please read the following warranty information to help ensure satisfaction with your Yamaha.

This model was manufactured with specifications appropriate for sale and use in the U.S.A. and Canada. Please note the following information:

1. As explained in the Limited Warranty Statement, the Yamaha warranty covers your Yamaha when it is registered and used in your country of residence. If you are temporarily using a U.S.-registered outboard motor in Canada, or a Canada-registered outboard motor in the United States, and it needs warranty repairs, you should contact a nearby authorized Yamaha Outboard Motor Dealer for assistance. The local dealer will contact Yamaha on the owner's behalf so that needed repairs can be made as quickly as possible.
2. If you need repairs while temporarily using your Yamaha in another country, contact the local authorized Yamaha distributor for that country. Yamaha will work with that distributor to make the needed repairs as quickly as possible. If you have to pay for a repair that you believe your warranty would have covered at home, present all repair orders, receipts, or other related documents to your local dealer when you return home. He will be able to contact Yamaha on your behalf to see if any refund can be provided.

TIP:

Your Yamaha model may not be sold in some countries. Therefore, a Yamaha dealer outside the United States or Canada may not have all of the replacement parts or technical information available to provide proper service. This may unavoidably delay repairs. Thank you for your understanding should this happen.

3. If your Yamaha is registered or used primarily outside the United States or Canada, the warranty printed in this manual does not apply to you. Contact the dealer who sold the Yamaha marine power unit to you for customer support information.

ZMU05199

INDEX

6Y8 Multifunction fuel management meters	43	Cooling water.....	55
6Y8 Multifunction meters.....	38	Cowling, installing.....	51
6Y8 Multifunction speed & fuel meters	41	Cowling lock lever.....	29
6Y8 Multifunction speedometers.....	42	Cowling, removing.....	49
6Y8 Multifunction tachometers	38	C-Tick label.....	9
A		D	
Accident reporting	3	Digital speedometer.....	33
Alcohol and drugs.....	2	Digital tachometer	32
Alert system.....	44	E	
Anode(s), inspecting and replacing	85	Electric shock	1
Anti-fouling paint	19	Emergency equipment.....	20
Approval label of emission control certificate.....	20	Emergency, running single engine in an.....	92
Avoid collisions.....	3	Emergency, temporary action in.....	92
B		Emission control information	20
Basic boating rules (Rules of the road)...	5	Engine, checking	50
Battery	53	Engine oil	50
Battery, checking (electric start models).....	85	Engine oil, changing	75
Battery, connecting	86	Engine oil, filling	48
Battery, disconnecting.....	87	Engine oil requirements	17
Battery requirements	15	Engine shut-off cord (lanyard)	1, 50
Boat education and training	3	Engine shut-off cord (lanyard) and clip.....	26
Boat horsepower rating	14	Engine trouble alert.....	40
Boating organizations	4	F	
Boating safety.....	2	Filling fuel.....	53
Boating safety publications	4	First-time operation	48
Breaking in engine.....	48	Flushing device	30, 50
C		Flushing power unit	67
Carbon monoxide	2	Flushing with the flushing attachment (F200, LF200, F225).....	65
Checks after engine warm up.....	56	Free accelerator.....	25
Checks after starting engine.....	55	Fuel consumption meter	36
Checks before starting engine.....	48	Fuel economy	36
Cleaning and anticorrosion measures.....	66	Fuel filter, checking.....	49
Cleaning the outboard motor	67	Fuel filter/Water separator	30
Clock	34	Fuel flow meter	35
Components diagram.....	23	Fuel gauge	34
Control functions, checking.....	50	Fuel leaks, checking for	49
		Fuel level.....	49
		Fuel level-alert indicator	35

Fuel management meter.....	35	O	Operating engine	53
Fuel requirements.....	17		Operating in salt water or other conditions.....	63
Fuel system	49		Outboard motor disposal requirements	20
Fuse, replacing	93		Outboard motor (painted surface), checking	68
G			Outboard motor safety	1
Gasoline.....	2, 17		Outboard motor serial number	9
Gasoline Additives.....	19		Overheat alert	40, 44
Gasoline exposure and spills.....	2		Overheat-alert indicator.....	33
Gear oil, changing.....	82		Overloading	2
Greasing	72			
H		P	Passenger training	4
Hot parts.....	1		Passengers	2
Hour meter.....	32		People in the water.....	2
I			Periodic maintenance	68
Identification numbers record.....	9		Personal flotation devices (PFDs).....	2
Idle speed, inspecting	75		Power trim and tilt	1
Impact damage.....	92		Power trim and tilt switch (bottom cowling)	27
Installation requirements	14		Power trim and tilt switch (remote control)	27
K			Power trim and tilt switches (twin binnacle type)	28
Key number	9		Power trim and tilt system, checking ...	52
L			Power trim and tilt will not operate.....	94
Laws and regulations.....	4		Propeller	1
Low battery voltage-alert.....	41		Propeller, checking.....	80
Low battery voltage-alert indicator.....	35		Propeller (counter rotation models)	16
Low oil pressure alert	44		Propeller, installing	81
Low oil pressure-alert	39		Propeller, removing.....	80
Low oil pressure-alert indicator	33		Propeller selection	16
Lubrication.....	66	R	Read manuals and labels	10
M			Remote control box	24
Main switch	27		Remote control lever	25
Maintenance chart 1	69		Remote control requirements	15
Maintenance chart 2	71		Replacement parts	68
Maintenance interval guidelines	68		Rotating parts	1
Manufactured date label.....	20		Rules when encountering vessels	5
Modifications	2			
Mounting height.....	46			
Mounting outboard motor	15			
Mounting the outboard motor	46			

INDEX

S			
Sending fuel.....	54		
Shallow water	62		
Shifting.....	56		
Shifting (checks after engine warm up)	56		
Spark plug, cleaning and adjusting	74		
Specifications	13		
Speedometer	33		
Star labels.....	21		
Starting engine	54		
Start-in-gear protection.....	16		
Steering and sailing rules and sound signals	5		
Stop switches	56		
Stopping boat.....	57		
Stopping engine	57		
Storing outboard motor.....	64		
Submerged outboard motor.....	96		
		Water separator-alert indicator..... 38	
		Water separator-alert indicator blinks while cruising..... 94	
		Weather	3
		Wiring and connectors, inspecting	79
T			
Tachometer	32		
Throttle friction adjuster.....	26		
Tilt support lever.....	29		
Tilting up and down.....	60		
Transporting and storing outboard motor.....	64		
Trim meter	32		
Trim tab with anode.....	28		
Trimming outboard motor.....	58		
Trip meter	34		
Troubleshooting.....	89		
Twin-engine speed synchronizer.....	37		
V			
Voltmeter	35		
W			
Warming up engine	56		
Warning labels	10		
Warranty information (use outside the U.S.A. or Canada).....	99		
Warranty, limited.....	97		
Water separator alert.....	40		

For your best ownership experience, think **Genuine Yamaha!**

Genuine Yamaha Parts — Genuine Yamaha replacement parts are the exact same parts as the ones originally equipped on your vehicle, providing you with the performance and durability you have come to expect. Why settle for aftermarket parts that may not provide full confidence and satisfaction?

Genuine Yamaha Accessories — Yamaha only offers accessories that meet our high standards for quality and performance. Buy with confidence, knowing your Genuine Yamaha Accessories will fit right and perform right — right out of the box.

Yamalube — Take care of your Yamaha with legendary Yamalube oils, lubricants, and care products. They're formulated and approved by the toughest judges we know: the Yamaha engineering teams that know your Yamaha from the inside out.

Genuine Yamaha Service Manuals — Get the same factory manual for your vehicle that the technicians at your authorized Yamaha dealer use. Service manuals are available through your Yamaha dealer or you can order them directly through yamahapubs.com (USA only).

Genuine Yamaha products are available only from your Yamaha dealer.

Find out more at www.yamaha-motor in your country of residence.

©2012 Yamaha Motor Corporation, U.S.A.

©2019 Yamaha Motor Corporation, U.S.A.

