



©2019 Yamaha Motor Corporation, U.S.A.

F9.9
T9.9

OWNER'S MANUAL

U.S.A. Edition
LIT-18626-07-07
6G8-28199-1S

EMU25060

⚠ WARNING

The engine exhaust from this product contains chemicals known to the State of California to cause cancer, birth defects or other reproductive harm.

YAMAHA

LIT-CALIF-65-01

ZMU01690

Read this owner's manual carefully before operating your outboard motor.

Important manual information

EMU31280

To the owner

Thank you for choosing a Yamaha outboard motor. This Owner's Manual contains information needed for proper operation, maintenance and care. A thorough understanding of these simple instructions will help you obtain maximum enjoyment from your new Yamaha. If you have any question about the operation or maintenance of your outboard motor, please consult a Yamaha dealer. In this Owner's Manual particularly important information is distinguished in the following ways.



The Safety Alert Symbol means **ATTENTION! BECOME ALERT! YOUR SAFETY IS INVOLVED!**

EWM00780



WARNING

Failure to follow WARNING instructions could result in severe injury or death to the machine operator, a bystander, or a person inspecting or repairing the outboard motor.

ECM00700

CAUTION:

A CAUTION indicates special precautions that must be taken to avoid damage to the outboard motor.

NOTE:

A NOTE provides key information to make procedures easier or clearer.

Yamaha continually seeks advancements in product design and quality. Therefore, while this manual contains the most current product information available at the time of printing, there may be minor discrepancies between your machine and this manual. If there is any question concerning this manu-

al, please consult your Yamaha dealer.

NOTE:

The F9.9ER, F9.9MH, T9.9ER, T9.9EH and the standard accessories are used as a base for the explanations and illustrations in this manual. Therefore some items may not apply to every model.

EMU25110

F9.9, T9.9

OWNER'S MANUAL

©2006 by Yamaha Motor Corporation, USA

1st edition, April 2006

All rights reserved.

Any reprinting or unauthorized use without the written permission of Yamaha Motor Corporation, USA is expressly prohibited.

Printed in Japan

P/N LIT-18626-07-07

Table of contents

General information	1	Starter button	17
Identification numbers record	1	Main switch	18
Outboard motor serial number	1	Steering friction adjuster	18
Key number.....	1	Steering Lock Device	18
Emission control information	1	Trim rod (tilt pin)	19
North American models.....	1	Shallow water lever	19
Star labels	2	Tilt lock mechanism.....	19
Safety information	3	Tilt support lever for manual tilt model	19
Important labels.....	4	Top cowling lock lever(s) (turn type).....	20
Warning labels	4	Low oil pressure warning indicator	20
Caution labels	5	Operation	21
Basic boating rules (Rules of the road)	5	Installation.....	21
Steering and sailing rules and sound signals.....	5	Mounting the outboard motor	21
Rules when encountering vessels	6	Mounting height for sailboat	22
Other special situations.....	7	Clamping the outboard motor.....	22
Fueling instructions	8	Breaking in engine	23
Gasoline.....	9	Procedure for 4-stroke models.....	23
Engine oil	9	Preoperation checks	24
Battery requirement.....	10	Fuel	24
Battery specifications	10	Controls.....	24
Without a rectifier or Rectifier Regulator	10	Engine	24
Propeller selection.....	10	Checking the engine oil level	24
Start-in-gear protection	11	Filling fuel.....	25
Basic components	12	Ring Free Fuel Additive.....	25
Main components.....	12	Operating engine	26
Fuel tank	13	Feeding fuel (portable tank)	26
Fuel joint	13	Starting engine	27
Fuel gauge	13	Warming up engine.....	30
Fuel tank cap	13	Oil pressure indicator models.....	30
Air vent screw	13	Shifting.....	31
Remote control.....	13	Forward (tiller handle and remote control models)	31
Remote control lever.....	13	Reverse (manual tilt and hydro tilt models)	32
Neutral interlock trigger.....	14	Stopping engine	33
Neutral throttle lever.....	14	Procedure.....	33
Tiller handle	14	Trimming outboard motor.....	34
Gear shift lever.....	15	Adjusting trim angle for manual tilt models	34
Throttle grip.....	15	Adjusting boat trim	35
Throttle indicator	15	Tilting up and down.....	36
Throttle friction adjuster.....	16	Procedure for tilting up (manual tilt	
Engine stop lanyard switch	16		
Engine stop button	17		
Manual starter handle	17		

Table of contents

models).....	36	Connecting the battery.....	58
Procedure for tilting down (manual tilt models).....	37	Disconnecting the battery.....	59
Cruising in shallow water.....	37	Charging battery.....	59
Cruising in shallow water (manual tilt models).....	37	Checking top cowling.....	60
Cruising in other conditions.....	39	Coating the boat bottom.....	60
Maintenance.....	40	Trouble Recovery.....	61
Specifications.....	40	Troubleshooting.....	61
Transporting and storing outboard motor.....	42	Temporary action in emergency ...	64
Clamp screw mounting models.....	42	Impact damage.....	64
Storing outboard motor.....	42	Replacing fuse.....	64
Procedure.....	43	Starter will not operate.....	65
Lubrication.....	44	Emergency starting engine.....	65
Cleaning and anticorrosion measures.....	44	Engine fails to operate.....	66
Battery care.....	44	Cold engine fails to start.....	66
Cleaning the outboard motor.....	45	Treatment of submerged motor	67
Checking painted surface of motor.....	45	Procedure.....	67
Periodic maintenance.....	45	Consumer information.....	69
Replacement parts.....	45	Important warranty information for U.S.A. and Canada.....	69
Maintenance chart.....	46	YAMAHA MOTOR CORPORATION, U.S.A. FOUR- STROKE OUTBOARD MOTOR THREE-YEAR LIMITED WARRANTY.....	71
Maintenance chart (additional).....	47	IMPORTANT WARRANTY INFORMATION IF YOU USE YOUR YAMAHA OUTSIDE THE USA OR CANADA.....	73
Greasing.....	48		
Cleaning and adjusting spark plug.....	48		
Checking fuel system.....	49		
Checking fuel filter.....	50		
Inspecting idling speed.....	50		
Changing engine oil.....	50		
Checking wiring and connectors.....	52		
Exhaust leakage.....	52		
Water leakage.....	53		
Engine oil leakage.....	53		
Checking propeller.....	53		
Removing the propeller.....	54		
Installing the Propeller.....	54		
Changing gear oil.....	55		
Cleaning fuel tank.....	56		
Inspecting and replacing anode(s).....	57		
Checking battery (for electric start models).....	57		

General information

EMU25170

Identification numbers record

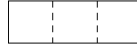

EMU25183

Outboard motor serial number

The outboard motor serial number is stamped on the label attached to the port side of the clamp bracket.

Record your outboard motor serial number in the spaces provided to assist you in ordering spare parts from your Yamaha dealer or for reference in case your outboard motor is stolen.

ZMU01693

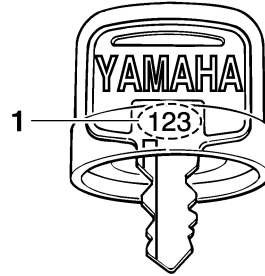

ZMU01694

1. Key number

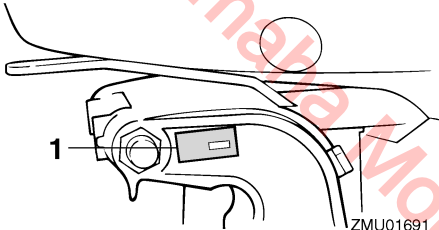

ZMU01691

1. Outboard motor serial number location

EMU25221

Emission control information

EMU25230

North American models

This engine conforms to U.S. Environmental Protection Agency (EPA) regulations for marine SI engines. See the label affixed to your engine for details.

EMU25242

Approval label of emission control certificate

This label is attached to the bottom cowling. New Technology; (4-stroke/HPDI) EM

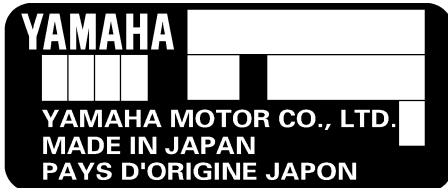

ZMU01692

EMU25190

Key number

If a main key switch is equipped with the motor, the key identification number is stamped on your key as shown in the illustration. Record this number in the space provided for reference in case you need a new key.

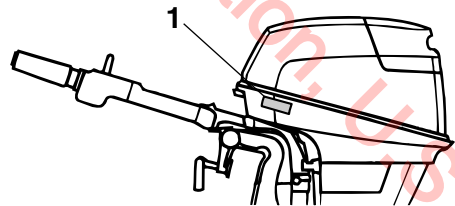

ZMU04352

1. Approval label location

General information

particular label.

EMISSION CONTROL INFORMATION		EM
ENGINE FAMILY :		
THIS ENGINE CONFORMS TO CALIFORNIA AND U.S. EPA EMISSION REGULATIONS FOR SI MARINE ENGINES. REFER TO THE OWNER'S MANUAL FOR MAINTENANCE SPECIFICATIONS AND ADJUSTMENTS.		
FEL : g/kw-hr	IDLE SPEED : rpm IN NEUTRAL	
SPARK PLUG :	SPARK PLUG GAP (mm) :	
DISPLACEMENT : cm ³	FUEL : GASOLINE	
ADVERTISED POWER : kw	VALVE LASH (mm) IN :	EX :
YAMAHA MOTOR CO.,LTD.		

ZMU05159

EMU25262

Manufactured date label

This label is attached to the clamp bracket or the swivel bracket.

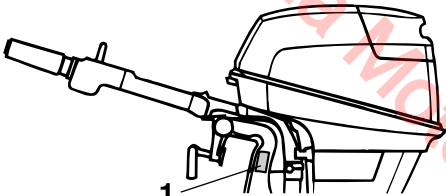

ZMU04353

1. Manufactured date label location

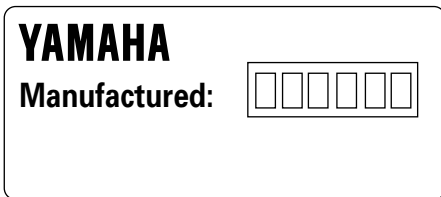

ZMU04346

EMU25272

Star labels

Your outboard motor is labeled with a California Air Resources Board (CARB) star label. See below for a description of your

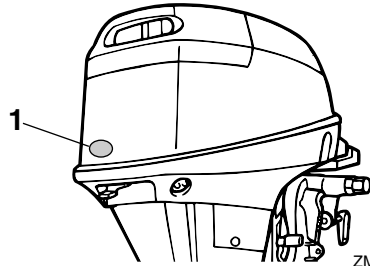

ZMU04354

1. Star labels location

EMU25280

One Star—Low Emission

The one-star label identifies engines that meet the Air Resources Board's 2001 exhaust emission standards. Engines meeting these standards have 75% lower emissions than conventional carbureted two-stroke engines. These engines are equivalent to the U.S. EPA's 2006 standards for marine engines.



ZMU01702

EMU25290

Two Stars—Very Low Emission

The two-star label identifies engines that meet the Air Resources Board's 2004 exhaust emission standards. Engines meeting these standards have 20% lower emissions than One Star-Low-Emission engines.

General information



ZMU01703

EMU25300

Three Stars—Ultra Low Emission

The three-star label identifies engines that meet the Air Resources Board's 2008 exhaust emission standards. Engines meeting these standards have 65% lower emissions than One Star-Low-Emission engines.



ZMU01704

EMU25362

Safety information

- Before mounting or operating the outboard motor, read this entire manual. Reading it should give you an understanding of the motor and its operation.
- Before operating the boat, read any owner's or operator's manuals supplied with it and all labels. Be sure you understand each item before operating.
- Do not overpower the boat with this outboard motor. Overpowering the boat could result in loss of control. The rated power of

the outboard should be equal to or less than the rated horsepower capacity of the boat. If the rated horsepower capacity of the boat is unknown, consult the dealer or boat manufacturer.

- Do not modify the outboard. Modifications could make the motor unfit or unsafe to use.
- Incorrect propeller selection and incorrect use may not only cause engine damage, but also adversely affect fuel consumption. Consult your dealer for correct use.
- Never operate after drinking alcohol or taking drugs. About 50% of all boating fatalities involve intoxication.
- Have an approved personal flotation device (PFD) on board for every occupant. It is a good idea to wear a PFD whenever boating. At a minimum, children and non-swimmers should always wear PFDs, and everyone should wear PFDs when there are potentially hazardous boating conditions.
- Gasoline is highly flammable, and its vapors are flammable and explosive. Handle and store gasoline carefully. Make sure there are no gas fumes or leaking fuel before starting the engine.
- This product emits exhaust gases which contain carbon monoxide, a colorless, odorless gas which may cause brain damage or death when inhaled. Symptoms include nausea, dizziness, and drowsiness. Keep cockpit and cabin areas well ventilated. Avoid blocking exhaust outlets.
- Check throttle, shift, and steering for proper operation before starting the engine.
- Attach the engine stop switch lanyard cord to a secure place on your clothing, or your arm or leg while operating. If you accidentally leave the helm, the cord will pull from

General information

the switch, stopping the engine.

- Know the marine laws and regulations where you will be boating—and obey them. For basic boating rules, see “Rules of the road” on page 5.
- Stay informed about the weather. Check weather forecasts before boating. Avoid boating in hazardous weather.
- Tell someone where you are going: leave a Float Plan with a responsible person. Be sure to cancel the Float Plan when you return.
- Use common sense and good judgment when boating. Know your abilities, and be sure you understand how your boat handles under the different boating conditions you may encounter. Operate within your limits, and the limits of your boat. Always operate at safe speeds, and keep a careful watch for obstacles and other traffic.
- Always watch carefully for swimmers during the engine operation.
- Stay away from swimming areas.
- When a swimmer is in the water near you shift into neutral and shut off the engine.
- Do not illegally discard empty containers used to replace or replenish oil. For the correct processing of empty containers, consult the dealer where you purchased the oil.
- When replacing oils used to lubricate the product (engine or gear oil), be sure to wipe away any spilled oil. Never pour oil without using a funnel or similar device. If necessary, verify the necessary replacement procedure with the dealer.
- Never illegally discard (dump) the product. Yamaha recommends consulting the dealer on discarding the product.

Be informed about boating safety. Additional publications and information can be obtained

from many organizations, including the following:

United States Coast Guard

Consumer Affairs Staff (G-BC)

Office of Boating, Public, and Consumer Affairs

U.S. Coast Guard Headquarters

Washington, D.C. 20593-0001

Boating Safety Hotline: 1-800-368-5647

National Marine Manufacturers Association (NMMA)

401 N. Michigan Ave.

Chicago, IL 60611

Marine Retailers Association of America

155 N. Michigan Ave.

Chicago, IL 60601

EMU25382

Important labels

EMU25395

Warning labels

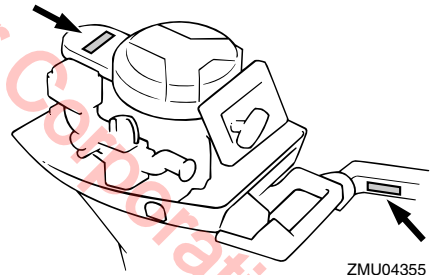

EMU25401

Label

EWM01260



- Be sure shift control is in neutral before starting engine. (except 2HP)
- Do not touch or remove electrical parts when starting or during operation.
- Keep hands, hair, and clothes away from flywheel and other rotating parts while engine is running.

General information

EMU25431

Label

EWM01300



- This engine is equipped with a neutral starting device.
 - The engine will not start unless the shift control is in neutral position.
-

EMU25465

Caution labels

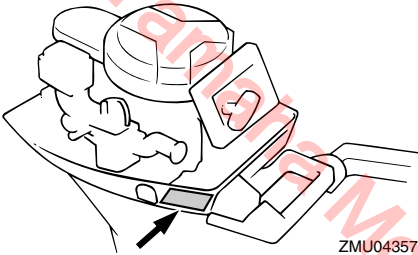

EMU25473

Label

ECM01191

CAUTION:

Transport and store the engine only as shown. Otherwise, engine damage could result from leaking oil.

EMU25500

Basic boating rules (Rules of the road)

Just as there are rules which apply when you are driving on streets and high ways, there are waterway rules which apply when you are driving your boat. These rules are used internationally, and are also enforced by the United States Coast Guard and local agencies. You should be aware of these rules, and follow them whenever you encounter another vessel on the water.

Several sets of rules prevail according to geographic location, but are all basically the

same as the International Rules of the Road. The rules presented here in your Owner's Manual are condensed, and have been provided for your convenience only. Consult your local U.S. Coast Guard Auxiliary or Department of Motor Vehicles for a complete set of rules governing the waters in which you will be using your boat.

EMU25510

Steering and sailing rules and sound signals

Whenever two vessels on the water meet one another, one vessel has the right-of-way; it is called the "stand-on" vessel. The vessel which does not have the right-of-way is called the "give-way" or "burdened" vessel. These rules determine which vessel has the right-of-way, and what each vessel should do.

Stand-on vessel

The vessel with the right-of-way has the duty to continue its course and speed, except to avoid an immediate collision. When you maintain your direction and speed, the other vessel will be able to determine how best to avoid you.

Give-way vessel

The vessel which does not have the right-of-way has the duty to take positive and timely action to stay out of the way of the Stand-On vessel. Normally, you should not cross in front of the vessel with the right-of-way. You should slow down or change directions briefly and pass behind the other vessel. You should always move in such a way that the operator of the other vessel can see what you are doing.

"The general prudential rule"

This rule is called Rule 2 in the International Rules and says,

"In obeying and construing these rules due regard shall be had to all dangers of naviga-

General information

tion and collision, and to any special circumstances, which may render a departure from the above rules necessary in order to avoid immediate danger.”

In other words, follow the standard rules except when a collision will occur unless both vessels try to avoid each other. If that is the case, both vessels become “Give-Way” vessels.

EMU25520

Rules when encountering vessels

There are three main situations which you may encounter with other vessels which could lead to a collision unless the Steering Rules are followed:

Meeting: (you are approaching another vessel head-on)

Crossing: (you are traveling across the other vessel’s path)

Overtaking: (you are passing or being passed by another vessel)

In the following illustration, your boat is in the center. You should give the right-of-way to any vessels shown in white area (you are the Give-Way vessel). Any vessels in the shaded area must yield to you (they are the Give-Way vessels). Both you and the meeting vessel must alter course to avoid each other.

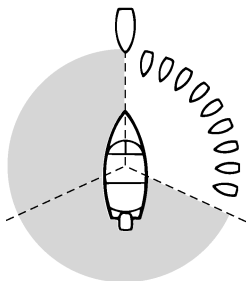

Meeting

If you are meeting another power vessel head on, and are close enough to run the risk

of collision, neither of you has the right-of-way! Both of you should alter course to avoid an accident. You should keep the other vessel on your port (left) side. This rule doesn’t apply if both of you will clear one another if you continue on your set course and speed.

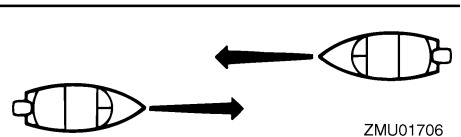
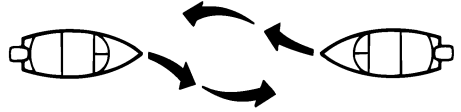

Crossing

When two power driven vessels are crossing each other’s path close enough to run the risk of collision, the vessel which has the other on the starboard (right) side must keep out of the way of the other. If the other vessel is on your right, you must keep out of its way; you are the Give-Way vessel. If the other vessel is on your port (left) side, remember that you should maintain course and direction, provided the other vessel gives you the right-of-way as it should.

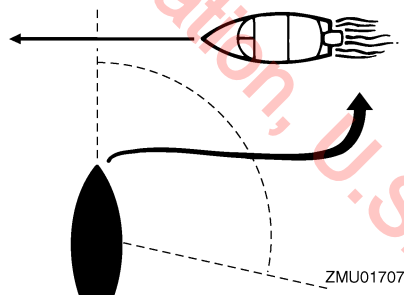

Overtaking

If you are passing another vessel, you are the “Give-Way” vessel. This means that the

General information

other vessel is expected to maintain its course and speed. You must stay out of its way until you are clear of it. Likewise, if another vessel is passing you, you should maintain your speed and direction so that the other vessel can steer itself around you.

EMU25530

Other special situations

There are three other rules you should be aware of when driving your boat around other vessels.

Narrow channels and bends

When navigating in narrow channels, you should keep to the right when it is safe and practical to do so. If the operator of a power-driven vessel is preparing to go around a bend that may obstruct the view of other water vessels, the operator should sound a prolonged blast on the whistle (4 to 6 seconds). If another vessel is around the bend, it too should sound the whistle. Even if no reply is heard, however, the vessel should still proceed around the bend with caution. If you navigate such waters with your boat, you will need to carry a portable air horn, available from local marine supply stores.

Fishing vessel right-of-way

All vessels which are fishing with nets, lines or trawls are considered to be “fishing vessels” under the International Rules. Vessels with trolling lines are not considered fishing vessels. Fishing vessels have the right-of-way regardless of position. Fishing vessels cannot, however, impede the passage of other vessels in narrow channels.

Sailing vessel right-of-way

Sailing vessels should normally be given the right-of-way. The exceptions to this are:

1. When the sailing vessel is overtaking the power-driven vessel, the power-driven vessel has the right-of-way.
2. Sailing vessels should keep clear of any

fishing vessel.

3. In a narrow channel, a sailing vessel should not hamper the safe passage of a power-driven vessel which can navigate only in such a channel.

Reading buoys and other markers

The waters of the United States are marked for safe navigation by the lateral system of buoyage. Simply put, buoys and markers have an arrangement of shapes, colors, numbers and lights to show which side of the buoy a boater should pass on when navigating in a particular direction. The markings on these buoys are oriented from the perspective of being entered from seaward (the boater is going towards the port). This means that red buoys are passed on the starboard (right) side when proceeding from open water into port, and black buoys are to port (left) side. When navigating out of port, your position with respect to the buoys should be reversed; red buoys should be to port and black buoys to starboard.

Many bodies of water used by boaters are entirely within the boundaries of a particular state. The Uniform State Waterway Marking System has been devised for these waters. This system uses buoys and signs with distinctive shapes and colors to show regulatory or advisory information. These markers are white with black letters and orange borders. They signify speed zones, restricted areas, danger areas, and general information.

Remember, markings may vary by geographic location. Always consult local boating authorities before driving your boat in unfamiliar waters.

General information

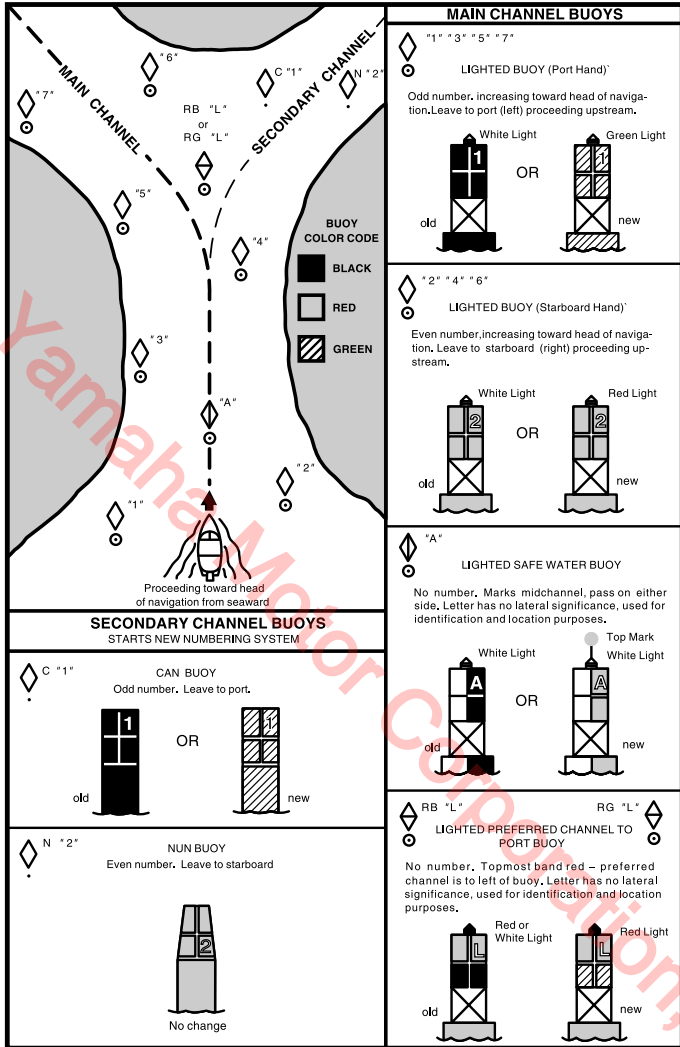

ZMU01708

EMU25540

Fueling instructions

EWM00010



WARNING

GASOLINE AND ITS VAPORS ARE HIGHLY FLAMMABLE AND EXPLOSIVE!

- Do not smoke when refueling, and keep

away from sparks, flames, or other sources of ignition.

- Stop engine before refueling.
- Refuel in a well-ventilated area. Refuel portable fuel tanks off the boat.
- Take care not to spill gasoline. If gasoline spills, wipe it up immediately with

General information

dry rags.

- Do not overfill the fuel tank.
- Tighten the filler cap securely after refueling.
- If you should swallow some gasoline, inhale a lot of gasoline vapor, or get gasoline in your eyes, get immediate medical attention.
- If any gasoline spills onto your skin, immediately wash with soap and water. Change clothing if gasoline spills on it.
- Touch the fuel nozzle to the filler opening or funnel to help prevent electrostatic sparks.

ECM00010

CAUTION:

Use only new clean gasoline which has been stored in clean containers and is not contaminated with water or foreign matter.

EMJ25570

Gasoline

If knocking or pinging occurs, use a different brand of gasoline or premium unleaded fuel.

Recommended gasoline:

Regular unleaded gasoline with a minimum octane rating of 86 (Pump Octane Number) = $(R+M)/2$

Gasohol

There are two types of gasohol: gasohol containing ethanol and that containing methanol. Gasohol containing ethanol can be used if ethanol content does not exceed 10% and the fuel meets minimum octane ratings. Yamaha does not recommend gasohol containing methanol because it can cause fuel system damage or engine performance problems.

EMU31440

Engine oil

Recommended engine oil:

YAMALUBE 4-M FC-W oil or 4-stroke motor oil with a combination of the following SAE and API oil classifications

Engine oil type SAE:

10W-30 or 10W-40

Engine oil grade API:

SE, SF, SG, SH, SJ, SL

Engine oil quantity (excluding oil filter):

1.0 L (1.06 US qt) (0.88 Imp. qt)

NOTE:

If the recommended engine oil grades are not available, select an alternative from the following chart according to the average temperatures in your area.

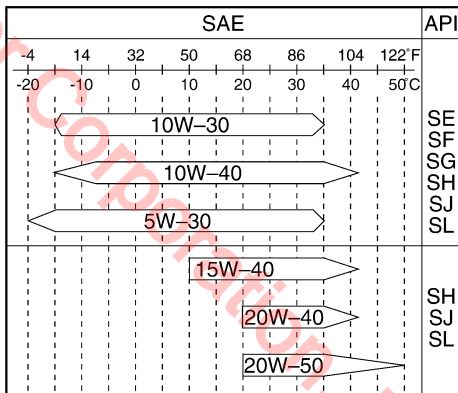

ZMU05190

ECM01050

CAUTION:

All 4-stroke engines are shipped from the factory without engine oil.



ZMU01710

EMU25690

Battery requirement

ECM01060

CAUTION:

Do not use a battery that does not meet the specified capacity. If a battery which does not meet specifications is used, the electric system could perform poorly or be overloaded, causing electric system damage.

For electric start models, choose a battery which meets the following specifications.

EMU25711

Battery specifications

Minimum cold cranking amps (CCA/
SAE):

F9.9ER 245.0 A

T9.9EH 245.0 A

T9.9ER 245.0 A

Minimum marine cranking amps (MCA/
ABYC):

F9.9ER 323.0 A

T9.9EH 323.0 A

T9.9ER 323.0 A

Minimum reserve capacity (RC/SAE):

F9.9ER 52 minutes

T9.9EH 52 minutes

T9.9ER 52 minutes

EMU25730

Without a rectifier or Rectifier Regulator

ECM01090

CAUTION:

A battery cannot be connected to models that do not have a rectifier or Rectifier Regulator.

If you wish to use a battery with the models without a rectifier or Rectifier Regulator, install an optional Rectifier Regulator.

Using a maintenance-free battery with the above models can shorten the life of the battery significantly.

Install an optional Rectifier Regulator or use accessories rated to withstand 18 volts or higher with the above models. Consult your Yamaha dealer for details on installing an optional Rectifier Regulator.

EMU25742

Propeller selection

The performance of your outboard motor will be critically affected by your choice of propeller, as an incorrect choice could adversely affect performance and could also seriously damage the motor. Engine speed depends on the propeller size and boat load. If engine speed is too high or too low for good engine performance, this will have an adverse effect on the engine.

Yamaha outboard motors are fitted with propellers chosen to perform well over a range of applications, but there may be uses where a propeller with a different pitch would be more appropriate. For a greater operating load, a smaller-pitch propeller is more suitable as it enables the correct engine speed to be maintained. Conversely, a larger-pitch propeller is more suitable for a smaller operating load.

Yamaha dealers stock a range of propellers,

General information

and can advise you and install a propeller on your outboard that is best suited to your application.

For instructions on propeller removal and installation, see page 53.

EMU25770

Start-in-gear protection

Yamaha outboard motors or Yamaha-approved remote control units are equipped with start-in-gear protection device(s). This feature permits the engine to be started only when it is in neutral. Always select neutral before starting the engine.

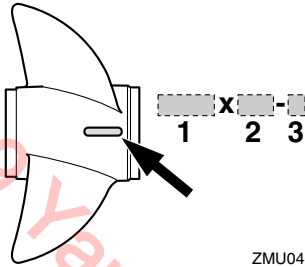

ZMU04605

1. Propeller diameter in inches
2. Propeller pitch in inches
3. Type of propeller (propeller mark)

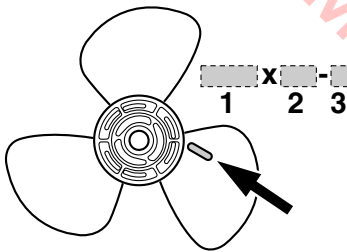

ZMU04604

1. Propeller diameter in inches
2. Propeller pitch in inches
3. Type of propeller (propeller mark)

NOTE:

Select a propeller which will allow the engine to reach the middle or upper half of the operating range at full throttle with the maximum boat load. If operating conditions such as light boat loads then allow the engine r/min to rise above the maximum recommended range, reduce the throttle setting to maintain the engine in the proper operating range.

Basic components

EMU25799

Main components

NOTE:

* May not be exactly as shown; also may not be included as standard equipment on all models.

F9.9, T9.9

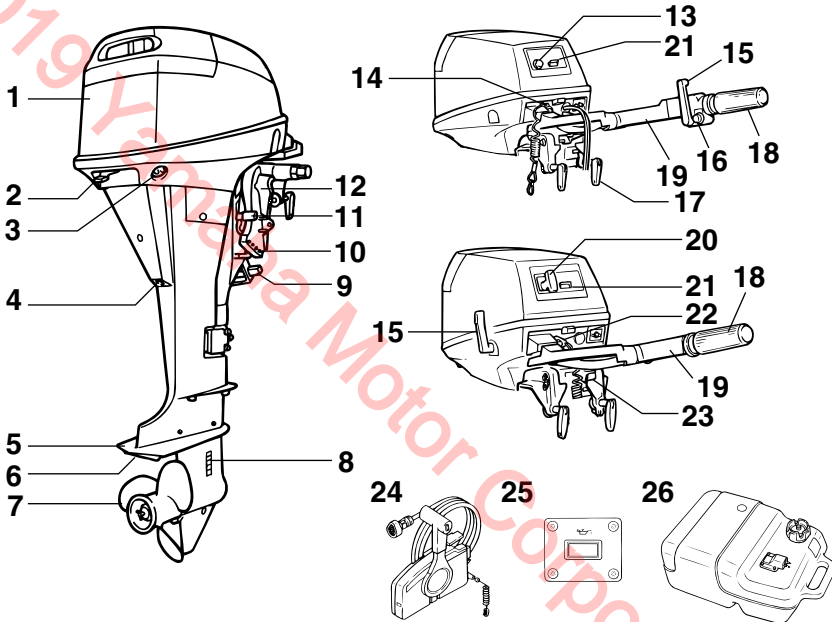

ZMU04360

1. Top cowling
2. Top cowling lock lever(s)
3. Cooling water pilot hole
4. Drain screw
5. Anti-cavitation plate
6. Anode
7. Propeller
8. Cooling water inlet
9. Shallow water lever*
10. Trim rod
11. Tilt support lever
12. Clamp bracket
13. Starter button*
14. Engine stop lanyard switch

15. Gear shift lever*
16. Engine stop button*
17. Transom clamp handle
18. Throttle grip*
19. Tiller handle*
20. Manual starter handle*
21. Oil pressure indicator
22. Engine stop button/Engine stop lanyard switch
23. Tilt lock lever
24. Remote control box (side mount type)*
25. Oil pressure indicator panel
26. Fuel tank*

Basic components

EMU25802

Fuel tank

If your model was equipped with a portable fuel tank, its function is as follows.

EWM00020

WARNING

The fuel tank supplied with this engine is its dedicated fuel reservoir and must not be used as a fuel storage container. Commercial users should conform to relevant licensing or approval authority regulations.

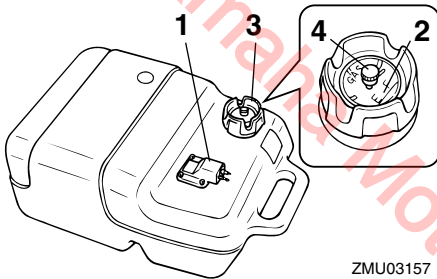

ZMU03157

1. Fuel joint
2. Fuel gauge
3. Fuel tank cap
4. Air vent screw

EMU25830

Fuel joint

This joint is used to connect the fuel line.

EMU25841

Fuel gauge

This gauge is located on either the fuel tank cap or on the fuel joint base. It shows the approximate amount of fuel remaining in the tank.

EMU25850

Fuel tank cap

This cap seals the fuel tank. When removed, the tank can be filled with fuel. To remove the cap, turn it counterclockwise.

EMU25860

Air vent screw

This screw is on the fuel tank cap. To loosen the screw, turn it counterclockwise.

EMU26180

Remote control

The remote control lever actuates both the shifter and the throttle. The electrical switches are mounted on the remote control box.

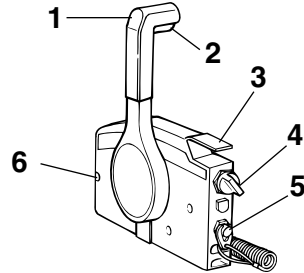

ZMU04862

1. Remote control lever
2. Neutral interlock trigger
3. Neutral throttle lever
4. Main switch / choke switch
5. Engine stop lanyard switch
6. Throttle friction adjuster

EMU26190

Remote control lever

Moving the lever forward from the neutral position engages forward gear. Pulling the lever back from neutral engages reverse. The engine will continue to run at idle until the lever is moved about 35° (a detent can be felt). Moving the lever farther opens the throttle, and the engine will begin to accelerate.

Basic components

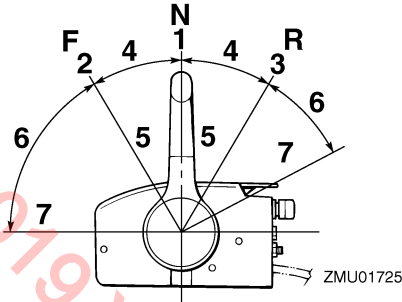

1. Neutral "N"
2. Forward "F"
3. Reverse "R"
4. Shift
5. Fully closed
6. Throttle
7. Fully open

EMU26201

Neutral interlock trigger

To shift out of neutral, first pull the neutral interlock trigger up.

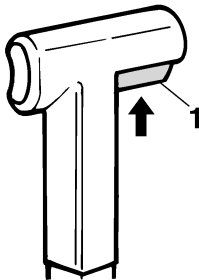

1. Neutral interlock trigger

EMU26211

Neutral throttle lever

To open the throttle without shifting into either forward or reverse, put the remote control lever in the neutral position and lift the neutral throttle lever.

NOTE:

The neutral throttle lever will operate only

when the remote control lever is in neutral. The remote control lever will operate only when the neutral throttle lever is in the closed position.

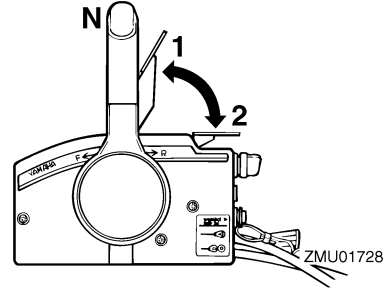

1. Fully open
2. Fully closed

EMU25911

Tiller handle

To change direction, move the tiller handle to the left or right as necessary.

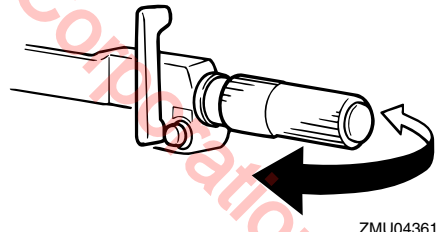

ZMU04361

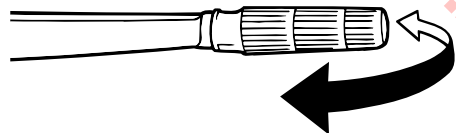

ZMU04449

Basic components

EMU25922

Gear shift lever

Pulling the gear shift lever towards you puts the engine in forward gear so that the boat moves ahead. Pushing the lever away from you puts the engine in reverse gear so that the boat moves astern.

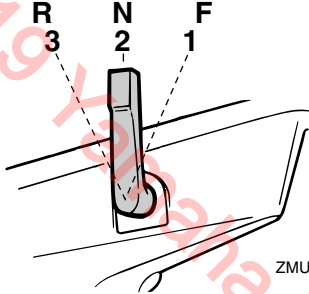

ZMU02902

1. Forward "F"
2. Neutral "N"
3. Reverse "R"

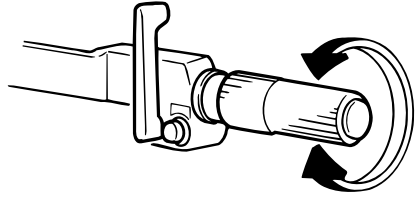

ZMU04363

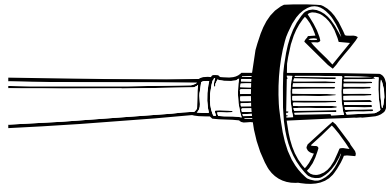

ZMU04448

EMU25961

Throttle indicator

The fuel consumption curve on the throttle indicator shows the relative amount of fuel consumed for each throttle position. Choose the setting that offers the best performance and fuel economy for the desired operation.

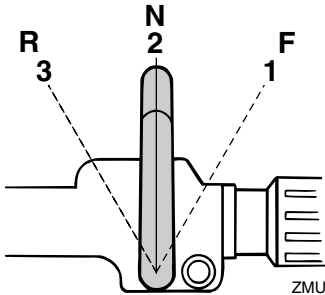

ZMU04362

1. Forward "F"
2. Neutral "N"
3. Reverse "R"

EMU25941

Throttle grip

The throttle grip is on the tiller handle. Turn the grip counterclockwise to increase speed and clockwise to decrease speed.

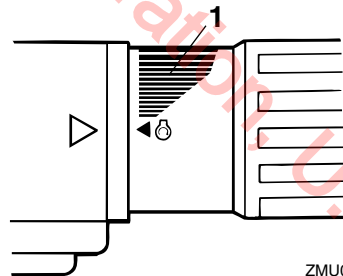

ZMU04450

1. Throttle indicator

EMU25971

Throttle friction adjuster

A friction device provides adjustable resistance to movement of the throttle grip or the remote control lever, and can be set according to operator preference.

To increase resistance, turn the adjuster clockwise. To decrease resistance, turn the adjuster counterclockwise.

EWM00031

WARNING

Do not overtighten the friction adjuster. If there is too much resistance, it could be difficult to move the remote control lever or throttle grip, which could result in an accident.

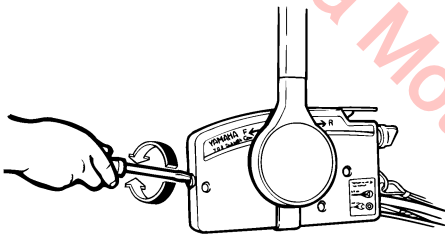

ZMU01714

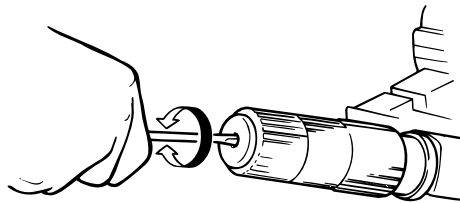

ZMU04364

When constant speed is desired, tighten the adjuster to maintain the desired throttle setting.

EMU25990

Engine stop lanyard switch

The lock plate must be attached to the engine stop switch for the engine to run. The lanyard should be attached to a secure place on the operator's clothing, or arm or leg. Should the operator fall overboard or leave the helm, the lanyard will pull out the lock plate, stopping ignition to the engine. This will prevent the boat from running away under power.

EWM00120

WARNING

- Attach the engine stop switch lanyard to a secure place on your clothing, or your arm or leg while operating.
- Do not attach the lanyard to clothing that could tear loose. Do not route the lanyard where it could become entangled, preventing it from functioning.
- Avoid accidentally pulling the lanyard during normal operation. Loss of engine power means the loss of most steering control. Also, without engine power, the boat could slow rapidly. This could cause people and objects in the boat to be thrown forward.

NOTE:

The engine cannot be started with the lock plate removed.

Basic components

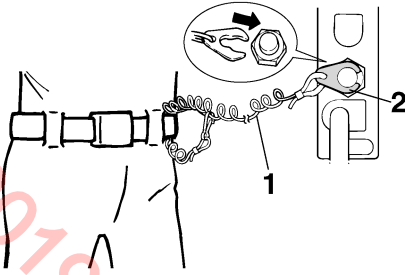

ZMU01716

1. Lanyard
2. Lock plate

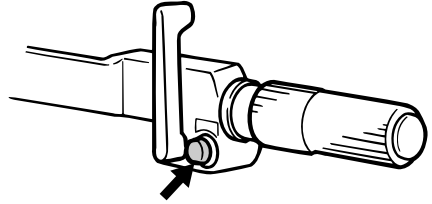

ZMU04367

EMU26070

Manual starter handle

To start the engine, first gently pull the handle out until resistance is felt. From that position, then pull the handle straight out quickly to crank the engine.

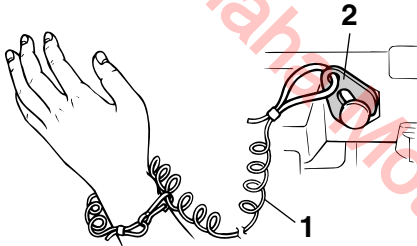

ZMU04365

1. Lanyard
2. Lock plate

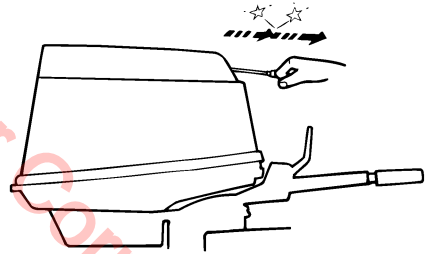

ZMU02735

EMU26001

Engine stop button

To open the ignition circuit and stop the engine, push this button.

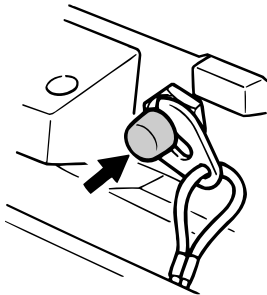

ZMU04366

EMU26080

Starter button

To start the engine with the electric starter, push the starter button.

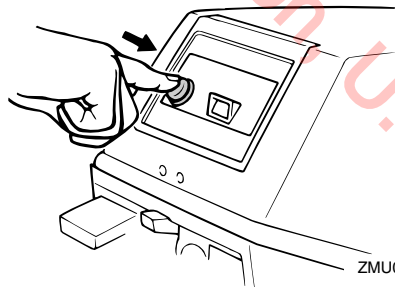

ZMU04368

Basic components

EMU26090

Main switch

The main switch controls the ignition system; its operation is described below.

- “OFF” (off)

With the main switch in the “OFF” (off) position, the electrical circuits are off, and the key can be removed.

- “ON” (on)

With the main switch in the “ON” (on) position, the electrical circuits are on, and the key cannot be removed.

- “START” (start)

With the main switch in the “START” (start) position, the starter motor turns to start the engine. When the key is released, it returns automatically to the “ON” (on) position.

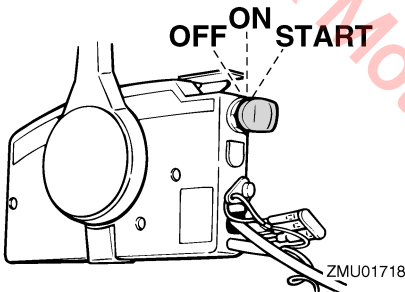

EMU26122

Steering friction adjuster

A friction device provides adjustable resistance to the steering mechanism, and can be set according to operator preference. An adjusting screw or bolt is located on the swivel bracket.

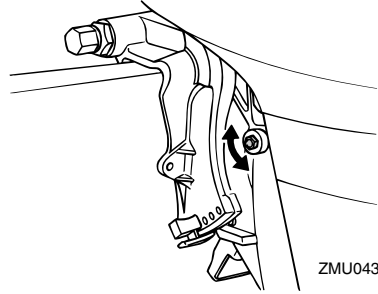

To increase resistance, turn the adjuster clockwise.

To decrease resistance, turn the adjuster counterclockwise.

EWM00040

WARNING

Do not overtighten the friction adjuster. If there is too much resistance, it could be difficult to steer, which could result in an accident.

EMU26170

Steering Lock Device

A boat with a rudder (such as a sailboat) can be steered with the boat's rudder if the engine is locked in the straight-ahead position. Lock the steering lock lever to the steering lock plate.

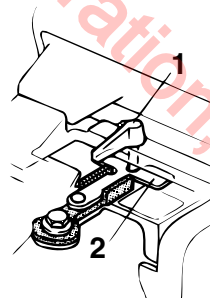

1. Steering lock lever
2. Steering lock plate

Basic components

NOTE:

If the sailboat does not move straight ahead when engine is locked with the steering lock lever and the boat's rudder is set straight, re-adjust the outboard's steering handle angle with the adjustment bolts.

If the engine is forced to turn right or left when the steering is locked, the steering plate is designed to break to protect the outboard motor. If the plate breaks, remove the screw and replace the plate.

NOTE:

A spare plate is contained in the outboard's original packing.

EMU26261

Trim rod (tilt pin)

The position of the trim rod determines the minimum trim angle of the outboard motor in relation to the transom.

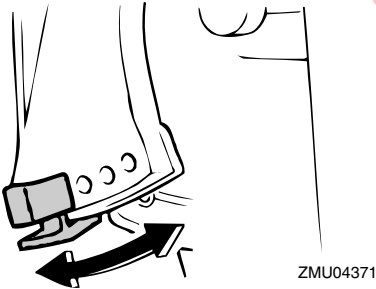

EMU26270

Shallow water lever

Lifting this lever will tilt the motor up partially to provide more clearance when operating in shallow water.

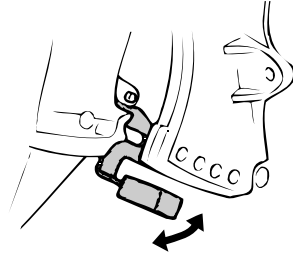

EMU26312

Tilt lock mechanism

The tilt lock mechanism is used to prevent the outboard motor from lifting out of the water when in reverse gear.

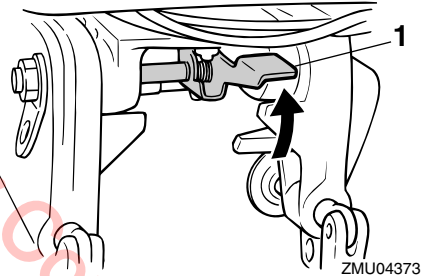

1. Tilt lock lever

To lock it, set the tilt lock lever in the "lock" position. To release, push the tilt lock lever in the "release" position.

EMU26350

Tilt support lever for manual tilt model

To keep the outboard motor in the tilted up position, lock the tilt support lever to the swivel bracket.

Basic components

and add oil as needed. If the lamp goes off when the oil level is correct, consult your Yamaha dealer.

ECM01130

CAUTION:

Do not continue to run the engine if the oil pressure indicator lamp is off. Serious engine damage could occur.

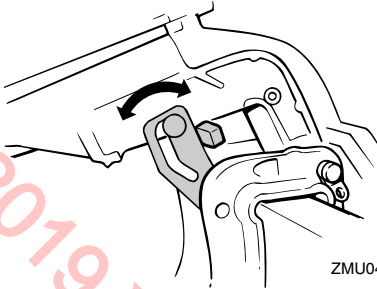

ZMU04374

EMU26372

Top cowling lock lever(s) (turn type)

To remove the engine top cowling, turn the lock lever(s) and lift off the cowling. When installing the cowling, check to be sure it fits properly in the rubber seal. Then lock the cowling again by returning the lever(s) to the lock position.

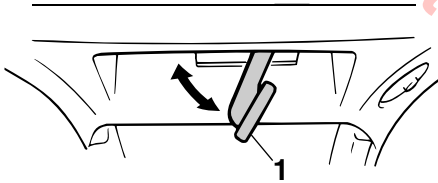

ZMU04375

1. Top cowling lock lever(s)

EMU26511

Low oil pressure warning indicator

The oil pressure lamp is on when the engine is running and oil pressure is normal. If oil pressure drops too low, the lamp goes off. As an additional alert of the low oil pressure condition, the engine runs roughly and will not exceed about 2000 rpm.

If the oil lamp goes out or does not come on when the engine is running, stop the engine as soon as it is safe to do so. Check oil level

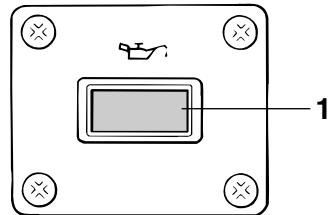

ZMU04442

1. Oil pressure indicator

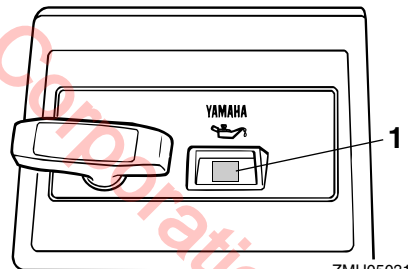

ZMU05031

1. Oil pressure indicator

Operation

EMU26901

Installation

ECM00110

CAUTION:

Incorrect engine height or obstructions to smooth water flow (such as the design or condition of the boat, or accessories such as transom ladders or depth finder transducers) can create airborne water spray while the boat is cruising. Severe engine damage may result if the motor is operated continuously in the presence of airborne water spray.

NOTE:

During water testing check the buoyancy of the boat, at rest, with its maximum load. Check that the static water level on the exhaust housing is low enough to prevent water entry into the powerhead, when water rises due to waves when the outboard is not running.

EMU26910

Mounting the outboard motor

EWM00820

WARNING

- Overpowering a boat could cause severe instability. Do not install an outboard motor with more horsepower than the maximum rating on the capacity plate of the boat. If the boat does not have a capacity plate, consult the boat manufacturer.
- The information presented in this section is intended as reference only. It is not possible to provide complete instructions for every possible boat and motor combination. Proper mounting depends in part on experience and the

specific boat and motor combination.

EWM00830

WARNING

Improper mounting of the outboard motor could result in hazardous conditions such as poor handling, loss of control, or fire hazards. Observe the following:

- For permanently mounted models, your dealer or other person experienced in proper rigging should mount the motor. If you are mounting the motor yourself, you should be trained by an experienced person.
- For portable models, your dealer or other person experienced in proper outboard motor mounting should show you how to mount your motor.

Mount the outboard motor on the center line (keel line) of the boat, and ensure that the boat itself is well balanced. Otherwise the boat will be hard to steer. For boats without a keel or which are asymmetrical, consult your dealer.

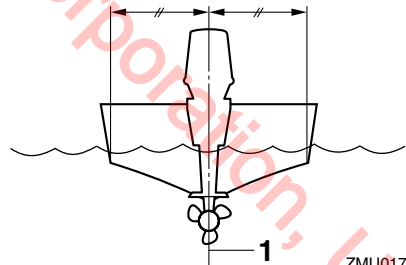

1. Center line (keel line)

EMU26920

Mounting height

To run your boat at optimum efficiency, the water resistance (drag) of the boat and outboard motor must be made as little as possible. The mounting height of the outboard

motor greatly affects the water resistance. If the mounting height is too high, cavitation tends to occur, thus reducing the propulsion; and if the propeller tips cut the air, the engine speed will rise abnormally and cause the engine to overheat. If the mounting height is too low, the water resistance will increase and thereby reduce engine efficiency. Mount the outboard motor so that the anti-cavitation plate is between the bottom of the boat and a level 25 mm (1 in.) below it.

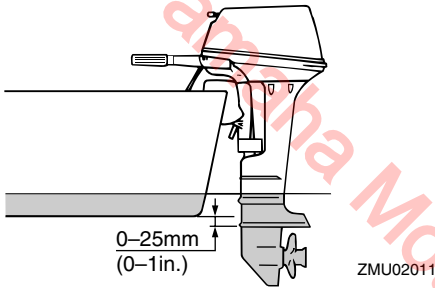

NOTE:

- The optimum mounting height of the outboard motor is affected by the boat and motor combination and the desired use. Test runs at different heights can help determine the optimum mounting height. Consult your Yamaha dealer or boat manufacturer for further information on determining the proper mounting height.
- For instructions on setting the trim angle of the outboard motor, see page 34.

EMU26960

Mounting height for sailboat

When mounting the outboard motor on the motor bracket of a sailboat, check the following points:

- When using the outboard motor, the cavitation plate should be 50 mm (2 in.) or more below the water surface to prevent propeller damage. Because a sailboat can

pitch considerably, mount the outboard motor low enough so that the propeller will not contact the water surface during motor-powered operation.

- When sailing, the outboard motor should be able to be tilted up out of the water so the propeller does not contact the water spray. Disconnect the fuel line.
- Check that the outboard motor does not interfere with the rudder.
- Check that the engine can be easily started and stopped.
- Check the ease of operating the gear shift and throttle control.
- If mounting the outboard motor on a well-type boat, exhaust gases and blow-by gas flow must be allowed to exit the boat. A special kit designed for this purpose can be ordered through your Yamaha dealer.

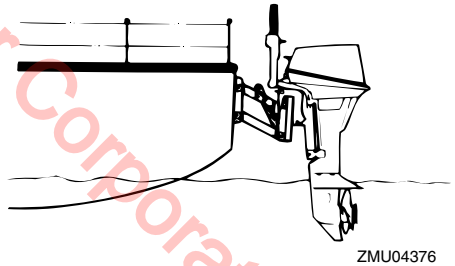

EMU26970

Clamping the outboard motor

1. Place the outboard motor on the transom so that it is positioned as close to the center as possible. Tighten the transom clamp screws evenly and securely. Occasionally check the clamp screws for tightness during operation of the outboard motor because they could be

Operation

come loose due to engine vibration.

EWM00640

WARNING

Loose clamp screws could allow the outboard motor to fall off or move on the transom. This could cause loss of control and serious injury. Make sure the transom screws are tightened securely. Occasionally check the screws for tightness during operation.

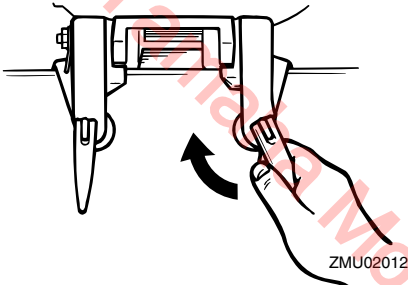

2. If the engine restraint cable attachment is equipped on your engine, an engine restraint cable or chain should be used. Attach one end to the engine restraint cable attachment and the other to a secure mounting point on the boat. Otherwise the engine could be completely lost if it accidentally falls off the transom.

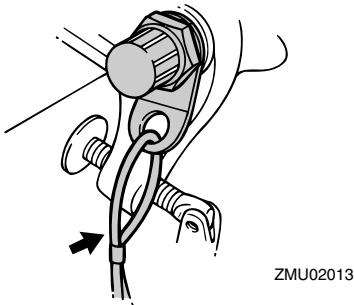

3. Secure the clamp bracket to the transom using the bolts provided with the out-

board (if packed). For details, consult your Yamaha dealer.

EWM00650

WARNING

Avoid using bolts, nuts or washers other than those contained in the engine packaging. If used, they must be of at least the same quality of material and strength and must be tightened securely. After tightening, test run the engine and check their tightness.

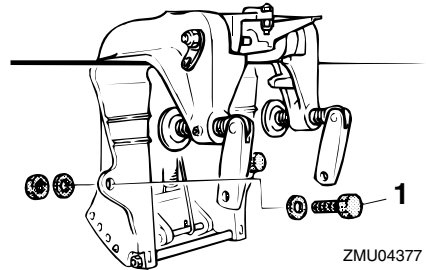

1. Bolts

EMU30173

Breaking in engine

Your new engine requires a period of break-in to allow mating surfaces of moving parts to wear in evenly. Correct break-in will help ensure proper performance and longer engine life.

ECM00800

CAUTION:

Failure to follow the break-in procedure could result in reduced engine life or even severe engine damage.

EMU27081

Procedure for 4-stroke models

Run the engine under load (in gear with a propeller installed) for 10 hours as follows.

1. First hour:

Run the engine at 2000 r/min or at approximately half throttle.

2. Second hour:

Run the engine at 3000 r/min or at approximately three-quarter throttle.

3. Remaining eight hours:

Run the engine at any speed. However, avoid operating at full throttle for more than 5 minutes at a time.

4. After the first 10 hours:

Operate the engine normally.

EMU27103

Preoperation checks

EWM00080

WARNING

If any item in the preoperation check is not working properly, have it inspected and repaired before operating the outboard motor. Otherwise an accident could occur.

ECM00120

CAUTION:

Do not start the engine out of water. Overheating and serious engine damage can occur.

EMU27111

Fuel

- Check to be sure you have plenty of fuel for your trip.
- Make sure there are no fuel leaks or gasoline fumes.
- Check fuel line connections to be sure they are tight (if equipped Yamaha fuel tank or boat tank).
- Be sure the fuel tank is positioned on a secure, flat surface, and that the fuel line is not twisted or flattened, or likely to contact sharp objects (if equipped Yamaha fuel tank or boat tank).

EMU27130

Controls

- Check throttle, shift, and steering for proper operation before starting the engine.
- The controls should work smoothly, without binding or unusual free play.
- Look for loose or damaged connections.
- Check operation of the starter and stop switches when the outboard motor is in the water.

EMU27140

Engine

- Check the engine and engine mounting.
- Look for loose or damaged fasteners.
- Check the propeller for damage.

EMU27163

Checking the engine oil level

1. Put the outboard motor in an upright position (not tilted).
2. Remove oil dipstick and wipe it clean.
3. Completely insert the dipstick and remove it again.
4. Check the oil level using the dipstick to be sure the level falls between the upper and lower marks. Fill with oil if it is below the lower mark, or drain to the specified level if it is above the upper mark.

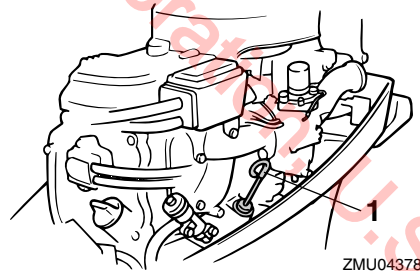

1. Oil dipstick

Operation

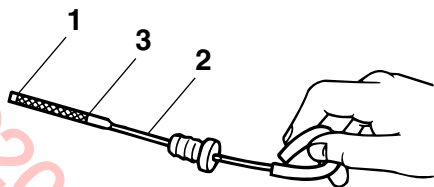

ZMU02082

1. Lower level mark
2. Oil dipstick
3. Upper level mark

NOTE:

Be sure to completely insert the dipstick into the dipstick guide.

EMU27433

Filling fuel

EWM00060



Gasoline and its vapors are highly flammable and explosive. Keep away from sparks, cigarettes, flames, or other sources of ignition.

1. Remove the fuel tank cap.
2. Carefully fill the fuel tank.
3. Securely close the cap after filling the tank. Wipe up any spilled fuel.

Fuel tank capacity:
25 L (6.60 US gal) (5.50 Imp.gal)

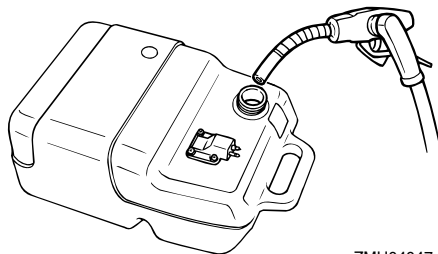

ZMU04047

EMU27270

Ring Free Fuel Additive

Gasoline is a precise blend of many different substances, each chosen to give certain characteristics. Gasoline blends have been changing in recent years in response to concerns about pollution and resulting emissions regulations. One of the most obvious changes has been the elimination of lead from most fuels.

As gasoline has changed, the amount of additives such as aromatics and oxygenates has increased. These additives are important for the engines in passenger cars, but they can have detrimental effects in marine engines, because of increased deposits in the combustion chamber. When enough deposits collect, piston rings begin sticking. Performance drops and engine wear increases dramatically.

While many additives available may reduce deposits, Yamaha recommends the use of **Ring Free Fuel Additive**, available from your Yamaha dealer. **Ring Free Fuel Additive** has repeatedly proven its ability to clean combustion deposits from inside the engine, notably the critical piston-ring-land area, and fuel system components. Follow product labeling for use instructions.

EMU27450

Operating engine

EMU27461

Feeding fuel (portable tank)

EWM00420

WARNING

- Before starting the engine, make sure that the boat is tightly moored and that you can steer clear of any obstructions. Be sure there are no swimmers in the water near you.
- When the air vent screw is loosened, gasoline vapor will be released. Gasoline is highly flammable, and its vapors are flammable and explosive. Refrain from smoking, and keep away from open flames and sparks while loosening the air vent screw.
- This product emits exhaust gases which contain carbon monoxide, a colorless, odorless gas which could cause brain damage or death when inhaled. Symptoms include nausea, dizziness, and drowsiness. Keep cockpit and cabin areas well ventilated. Avoid blocking exhaust outlets.

1. If there is an air vent screw on the fuel tank cap, loosen it 2 or 3 turns.

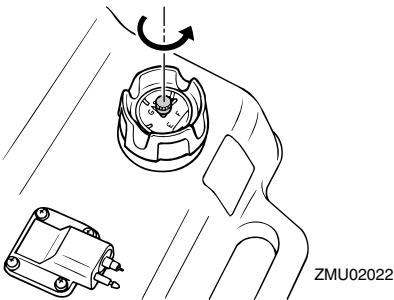

2. If there is a fuel joint on the motor, firmly connect the fuel line to the joint. Then firmly connect the other end of the fuel

line to the joint on the fuel tank.

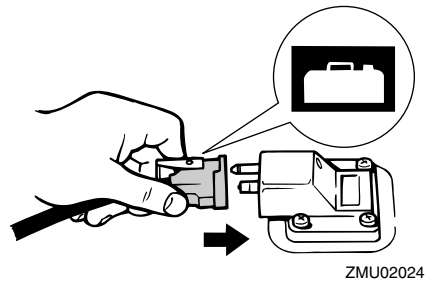
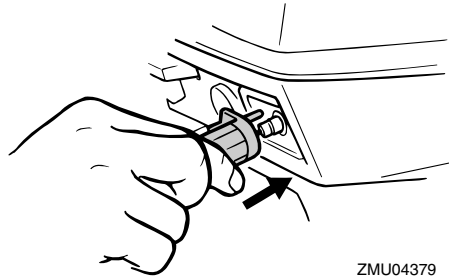

3. If a steering friction adjuster is provided on your outboard motor, securely attach the fuel line to the fuel line clamp.

NOTE:

During engine operation place the tank horizontally, otherwise fuel cannot be drawn from the fuel tank.

4. Squeeze the primer pump with the outlet end up until you feel it become firm.



Operation

EMU27490

Starting engine

EMU27541

Starting engine

1. Place the gear shift lever in neutral.

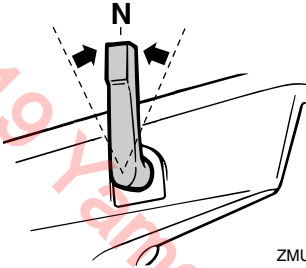

ZMU04380

NOTE:

The start-in-gear protection device prevents the engine from starting except when in neutral.

2. Attach the engine stop switch lanyard to a secure place on your clothing, or your arm or leg. Then install the lock plate on the other end of the lanyard into the engine stop switch.

EWM00120

WARNING

- Attach the engine stop switch lanyard to a secure place on your clothing, or your arm or leg while operating.
- Do not attach the lanyard to clothing that could tear loose. Do not route the lanyard where it could become entangled, preventing it from functioning.
- Avoid accidentally pulling the lanyard during normal operation. Loss of engine power means the loss of most steering control. Also, without engine power, the boat could slow rapidly. This could cause people and objects in the boat to be thrown forward.

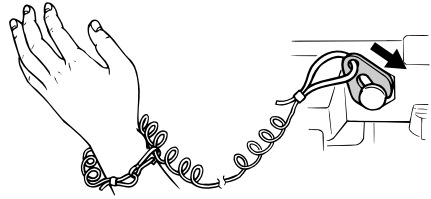

ZMU04381

3. Place the throttle grip in the "START" (start) position.

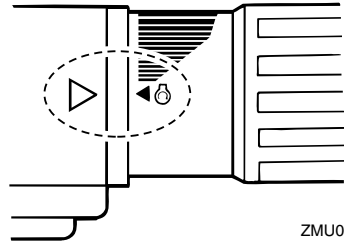

ZMU04382

4. Pull the manual starter handle slowly until you feel resistance. Then give a strong pull straight out to crank and start the engine. Repeat if necessary.

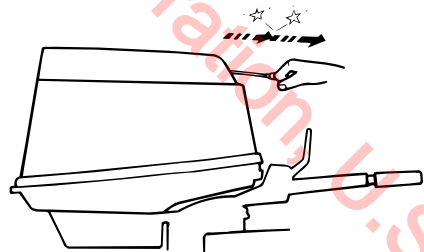

ZMU04383

5. After the engine starts, slowly return the manual starter handle to its original position before releasing it.

NOTE:

- When the engine is cold, it needs to be warmed up. For further information, see page 30.
- If the engine is warm and fails to start, open the throttle slightly and try to start the engine again. If the engine still fails to start, see page 61.

EMU27600

Electric start/prime start models

1. Place the gear shift lever in neutral.

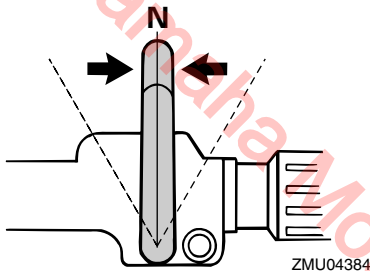

NOTE:

The start-in-gear protection device prevents the engine from starting except when in neutral.

2. Attach the engine stop switch lanyard to a secure place on your clothing, or your arm or leg. Then install the lock plate on the other end of the lanyard into the engine stop switch.

EWMO0120

WARNING

- Attach the engine stop switch lanyard to a secure place on your clothing, or your arm or leg while operating.
- Do not attach the lanyard to clothing that could tear loose. Do not route the lanyard where it could become entangled, preventing it from functioning.
- Avoid accidentally pulling the lanyard

during normal operation. Loss of engine power means the loss of most steering control. Also, without engine power, the boat could slow rapidly. This could cause people and objects in the boat to be thrown forward.

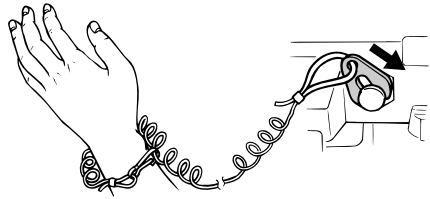

ZMU04385

3. Place the throttle grip in the "START" (start) position. After the engine starts, return the throttle to the fully closed position.

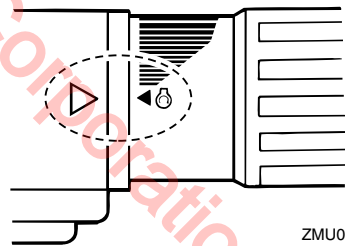

ZMU04386

4. Push the starter button to start the engine.

Operation

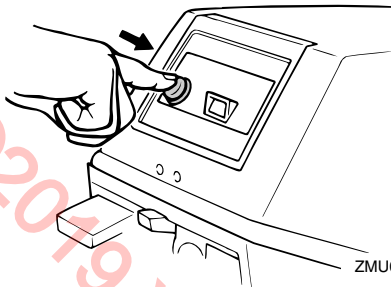

ZMU04387

5. Immediately after the engine starts, release the starter button and allow it to return to its original position.

ECM00160

CAUTION:

- Never push the starter button while the engine is running.
- Do not keep the starter motor turning for more than 5 seconds. If the starter motor is turned continuously for more than 5 seconds, the battery will be quickly discharged, thus making it impossible to start the engine. The starter can also be damaged. If the engine will not start after 5 seconds of cranking, release the starter button, wait 10 seconds, then crank the engine again.

NOTE:

- When the engine is cold, it needs to be warmed up. For further information, see page 30.
- If the engine is warm and fails to start, open the throttle slightly and try to start the engine again. If the engine still fails to start, see page 61.

EMU27662

Electric start and remote control models

1. Place the remote control lever in neutral.

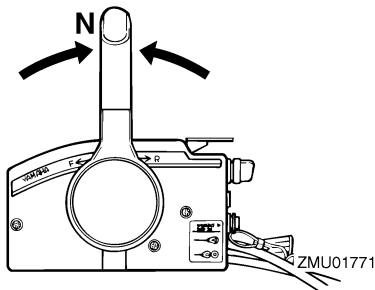

ZMU01771

NOTE:

The start-in-gear protection device prevents the engine from starting except when in neutral.

2. Attach the engine stop switch lanyard to a secure place on your clothing, or your arm or leg. Then install the lock plate on the other end of the lanyard into the engine stop switch.

EWM00120

WARNING

- Attach the engine stop switch lanyard to a secure place on your clothing, or your arm or leg while operating.
- Do not attach the lanyard to clothing that could tear loose. Do not route the lanyard where it could become entangled, preventing it from functioning.
- Avoid accidentally pulling the lanyard during normal operation. Loss of engine power means the loss of most steering control. Also, without engine power, the boat could slow rapidly. This could cause people and objects in the boat to be thrown forward.

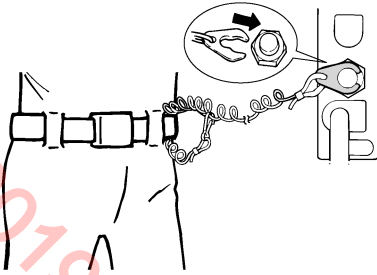

ZMU01772

3. Turn the main switch to “ON” (on).
4. Turn the main switch to “START” (start), and hold it for a maximum of 5 seconds.

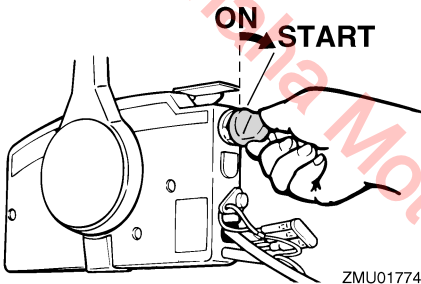

ZMU01774

5. Immediately after the engine starts, release the main switch and allow it to return to “ON” (on).

ECM00191

CAUTION:

- Never turn the main switch to “START” (start) while the engine is running.
- Do not keep the starter motor turning for more than 5 seconds. If the starter motor is turned continuously for more than 5 seconds, the battery will be quickly discharged, thus making it impossible to start the engine. The starter can also be damaged. If the engine will not start after 5 seconds of cranking, return the main switch to “ON” (on), wait 10 seconds, then crank the engine

again.

NOTE:

- When the engine is cold, it needs to be warmed up. For further information, see page 30.
- If the engine is warm and fails to start, open the throttle slightly and try to start the engine again. If the engine still fails to start, see page 61.

EMU27670

Warming up engine

EMU27721

Oil pressure indicator models

1. After starting the engine, allow it to idle for 3 minutes to warm up. Failure to do so will shorten engine life.
2. Be sure the oil pressure indicator stays on after starting the engine.
3. Check for a steady flow of water from the cooling water pilot hole.

ECM01430

CAUTION:

- If the oil pressure indicator goes off after the engine starts, stop the engine. Otherwise, serious engine damage could occur. Check the oil level and add oil if necessary. Consult your Yamaha dealer if the cause cannot be found.
- A continuous flow of water from the pilot hole shows that the water pump is pumping water through the cooling passages. If water is not flowing out of the pilot hole at all times while the engine is running, overheating and serious damage could occur. Stop the engine and check whether the cooling water inlet on the lower case or the cooling water pilot hole is blocked. Consult your Yamaha dealer if the problem cannot be located and corrected.

Operation

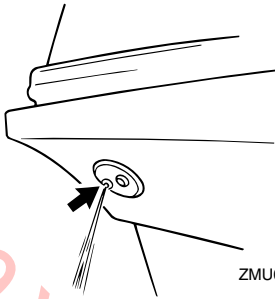

ZMU04393

EMU27740

firmly from neutral to forward.

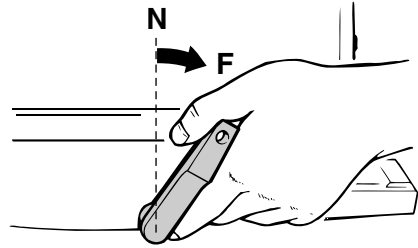

ZMU02866

Shifting

EWM00180

WARNING

Before shifting, make sure there are no swimmers or obstacles in the water near you.

ECM00220

CAUTION:

To change the boat direction or shifting position from forward to reverse or vice-versa, first close the throttle so that the engine idles (or runs at low speeds).

EMU27764

Forward (tiller handle and remote control models)

Tiller handle models

1. Place the throttle grip in the fully closed position.

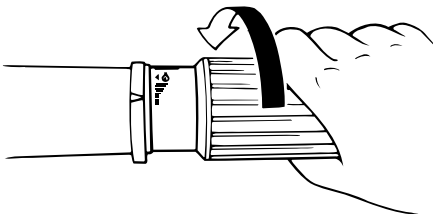

ZMU02030

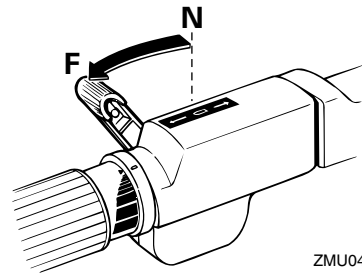

ZMU04394

Remote control models

1. Pull up the neutral interlock trigger (if equipped) and move the remote control lever quickly and firmly from neutral to forward.

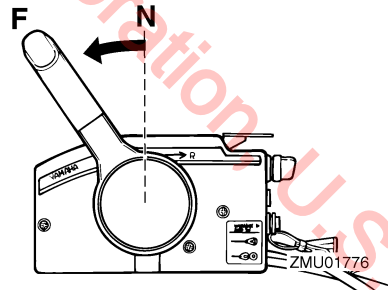

ZMU01776

2. Move the gear shift lever quickly and

EMU27796

Reverse (manual tilt and hydro tilt models)

EWM00190

WARNING

When operating in reverse, go slowly. Do not open the throttle more than half. Otherwise the boat could become unstable, which could result in loss of control and an accident.

Tiller handle models

1. Place the throttle grip in the fully closed position.

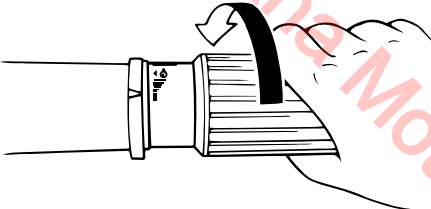

ZMU02030

2. On models equipped with a tilt lock lever, check that it is in the lock/down position.

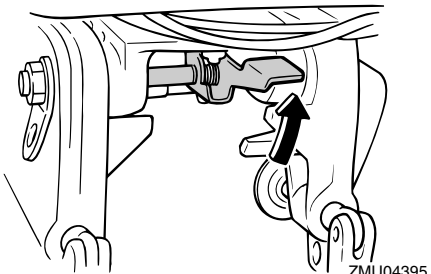

ZMU04395

3. Move the gear shift lever quickly and firmly from neutral to reverse.

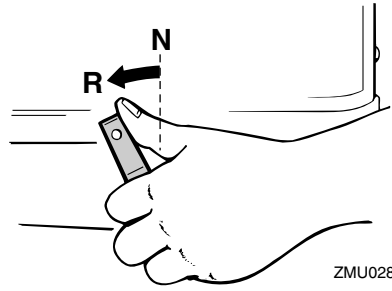

ZMU02867

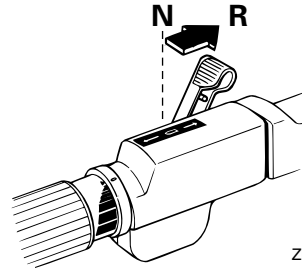

ZMU04396

Remote control models

1. Check that the tilt lock lever is in the lock position.

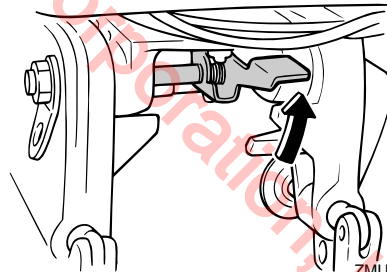

ZMU04397

2. Pull up the neutral interlock trigger (if equipped) and move the remote control lever quickly and firmly from neutral to reverse.

Operation

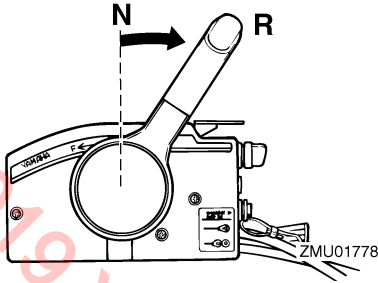

EMU27820

Stopping engine

Before stopping the engine, first let it cool off for a few minutes at idle or low speed. Stopping the engine immediately after operating at high speed is not recommended.

EMU27844

Procedure

1. Push and hold the engine stop button or turn the main switch to "OFF" (off).

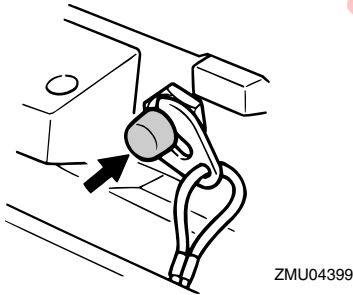

ZMU04399

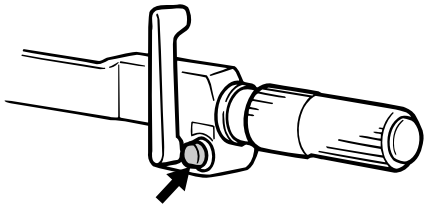

ZMU04398

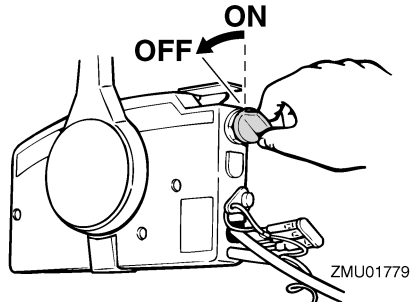

ZMU01779

2. After stopping the engine, disconnect the fuel line if there is a fuel joint on the outboard motor.

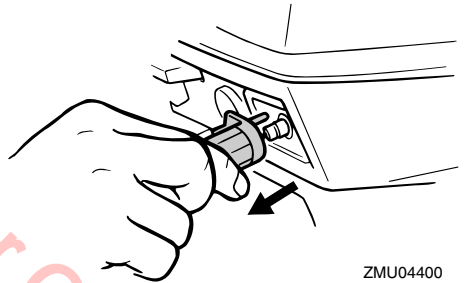

ZMU04400

3. Tighten the air vent screw on the fuel tank cap (if equipped).

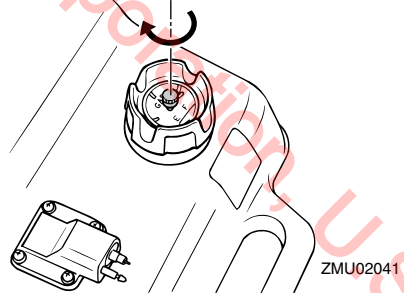

ZMU02041

4. Remove the key if the boat will be left unattended.

NOTE:

The engine can also be stopped by pulling the lanyard and removing the lock plate from

the engine stop switch, then turning the main switch to "OFF" (off).

EMU27861

Trimming outboard motor

The trim angle of the outboard motor helps determine the position of the bow of the boat in the water. Correct trim angle will help improve performance and fuel economy while reducing strain on the engine. Correct trim angle depends upon the combination of boat, engine, and propeller. Correct trim is also affected by variables such as the load in the boat, sea conditions, and running speed.

EWM00740



Excessive trim for the operating conditions (either trim up or trim down) can cause boat instability and can make steering the boat more difficult. This increases the possibility of an accident. If the boat begins to feel unstable or is hard to steer, slow down and/or readjust the trim angle.

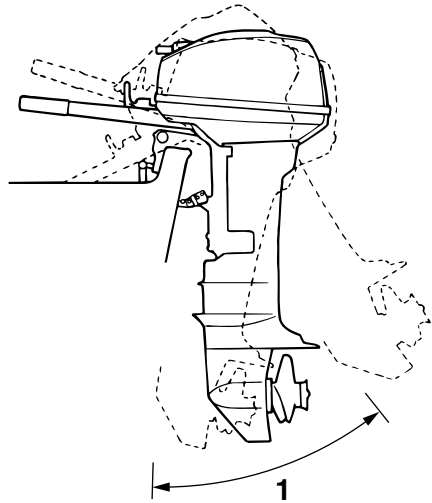

ZMU02858

1. Trim operating angle

EMU27872

Adjusting trim angle for manual tilt models

There are 4 or 5 holes provided in the clamp bracket to adjust the outboard motor trim angle.

1. Stop the engine.
2. Tilt the outboard motor up, and then remove the trim rod from the clamp bracket.

Operation

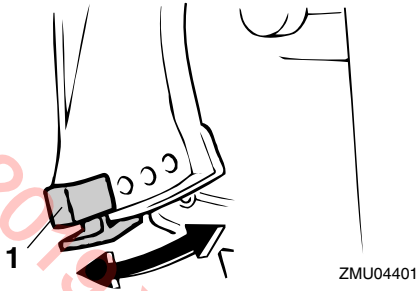

1. Trim rod

3. Reposition the rod in the desired hole. To raise the bow (“trim-out”), move the rod away from the transom. To lower the bow (“trim-in”), move the rod toward the transom.

Make test runs with the trim set to different angles to find the position that works best for your boat and operating conditions.

EWMM00400

WARNING

- Stop the engine before adjusting the trim angle.
- Use care to avoid being pinched when removing or installing the rod.
- Use caution when trying a trim position for the first time. Increase speed gradually and watch for any signs of instability or control problems. Improper trim angle can cause loss of control.

NOTE:

The outboard motor trim angle can be changed approximately 4 degrees by shifting the trim rod one hole.

EMU27911

Adjusting boat trim

When the boat is on plane, a bow-up attitude results in less drag, greater stability and efficiency. This is generally when the keel line of

the boat is up about 3 to 5 degrees. With the bow up, the boat may have a greater tendency to steer to one side or the other. Compensate for this as you steer. The trim tab can also be adjusted to help offset this effect. When the bow of the boat is down, it is easier to accelerate from a standing start onto plane.

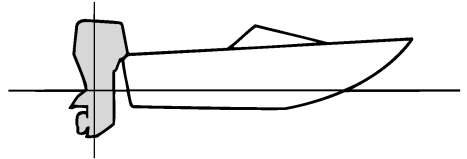

ZMU01784

Bow Up

Too much trim-out puts the bow of the boat too high in the water. Performance and economy are decreased because the hull of the boat is pushing the water and there is more air drag. Excessive trim-out can also cause the propeller to ventilate, which reduces performance further, and the boat may “porpoise” (hop in the water), which could throw the operator and passengers overboard.

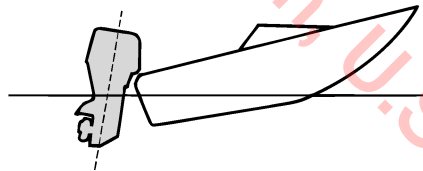

ZMU01785

Bow Down

Too much trim-in causes the boat to “plow” through the water, decreasing fuel economy

and making it hard to increase speed. Operating with excessive trim-in at higher speeds also makes the boat unstable. Resistance at the bow is greatly increased, heightening the danger of “bow steering” and making operation difficult and dangerous.

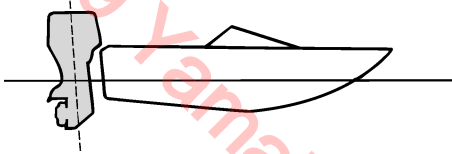

ZMU01786

NOTE:

Depending on the type of boat, the outboard motor trim angle may have little effect on the trim of the boat when operating.

EMU27933

Tilting up and down

If the engine will be stopped for some time or if the boat is moored in shallows, the outboard motor should be tilted up to protect the propeller and casing from damage by collision with obstructions, and also to reduce salt corrosion.

EWM00220

WARNING

Be sure all people are clear of the outboard motor when tilting up and down, also be careful not to pinch any body parts between the drive unit and engine bracket.

EWM00250

WARNING

Leaking fuel is a fire hazard. If there is a fuel joint on the outboard motor, disconnect the fuel line or close the fuel cock if

the engine will be tilted for more than a few minutes. Otherwise fuel may leak.

ECM00241

CAUTION:

- Before tilting the outboard motor, stop the engine by following the procedure on page 33. Never tilt the outboard motor while the engine is running. Severe damage from overheating can result.
- Do not tilt up the engine by pushing the tiller handle (if equipped) because this could break the handle.

EMU27953

Procedure for tilting up (manual tilt models)

1. Place the gear shift lever in neutral.

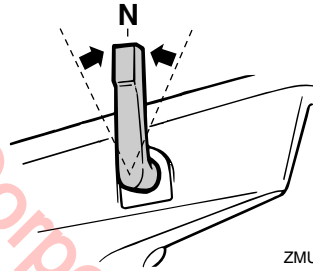

ZMU04451

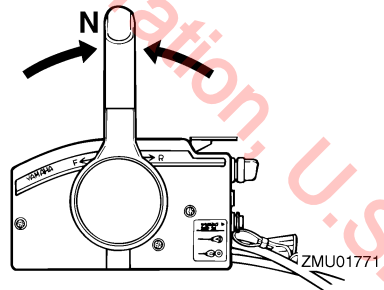

ZMU01771

Operation

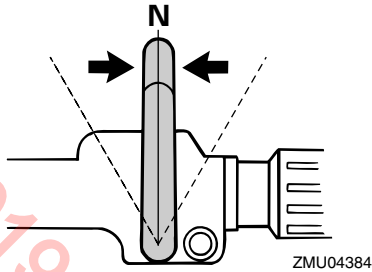

2. Disconnect the fuel line if a fuel joint is provided on the outboard motor.

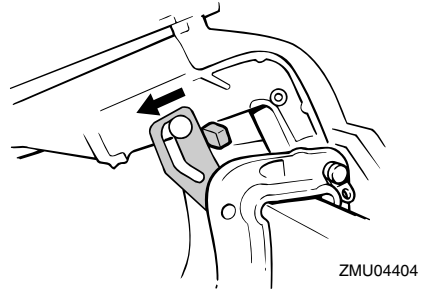

EMU28013

Procedure for tilting down (manual tilt models)

1. Slightly tilt the engine up.
2. On models equipped with a tilt support knob, pull it out.

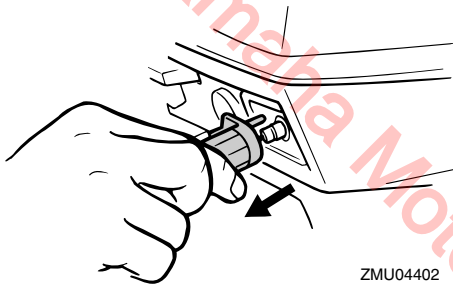

3. Place the tilt lock lever in the release position.

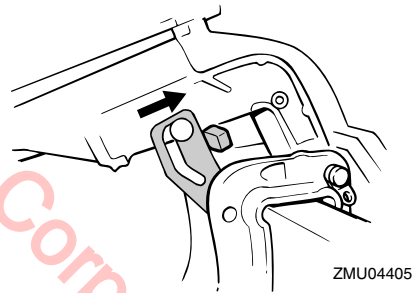

3. Slowly tilt the engine down.

EMU28060

Cruising in shallow water

The outboard motor can be tilted up partially to allow operation in shallow water.

EMU28071

Cruising in shallow water (manual tilt models)

EWM00710

WARNING

4. Hold the rear of the top cowling with one hand, tilt the engine up, and turn the tilt support lever to the lock position and support the engine.

- Place the gear shift in neutral before using the shallow water cruising system.
- Run the boat at the lowest possible speed when using the shallow water cruising system. The tilt lock mecha-

nism does not work while the shallow water cruising system is being used. Hitting an underwater obstacle could cause the outboard motor to lift out of the water, resulting in loss of control.

- Do not rotate the outboard motor 180° and operate the boat in reverse. Place the gear shift in reverse to operate the boat in reverse.
- Use extra care when operating in reverse. Too much reverse thrust can cause the outboard motor to lift out of the water, increasing the chance of accident and personal injury.
- Return the outboard motor to its normal position as soon as the boat is back in deeper water.

ECM00260

CAUTION:

Do not tilt the outboard motor up so that the cooling water inlet on the lower unit is above the surface of the water when setting up for and cruising in shallow water. Otherwise severe damage from overheating can result.

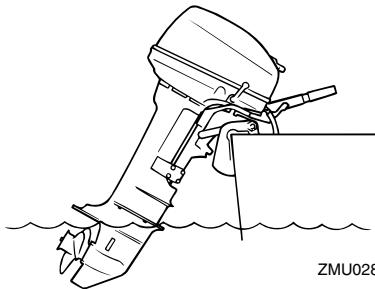

ZMU02868

EMU28152

Procedure

1. Place the gear shift lever in neutral.

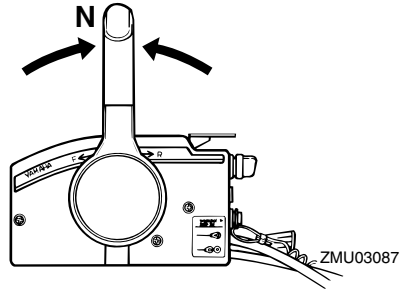

ZMU03087

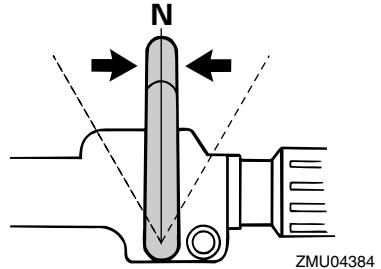

ZMU04384

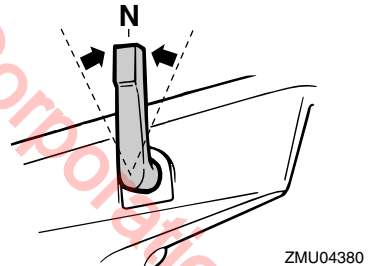

ZMU04380

2. Push the tilt lock lever down to the release position.

Operation

EMU28192

Cruising in other conditions

Cruising in salt water

After operating in salt water, flush the cooling water passages with fresh water to prevent them from becoming clogged with salt deposits.

NOTE:

For cooling system flushing instructions, see page 42.

Cruising in turbid water

Yamaha strongly recommends that you use the optional chromium-plated water pump kit (not available for some models) if you use the outboard motor in turbid or muddy water conditions.

3. Slightly tilt the outboard motor up and pull the shallow water lever toward the transom.

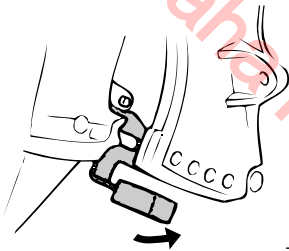
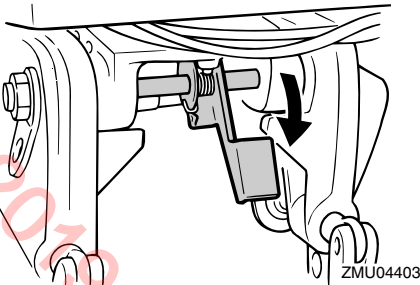

4. To return the outboard motor to the normal position, place the gear shift lever in neutral, then slightly tilt the outboard motor up. Push the shallow water lever down. Set the tilt lock lever to the lock position and slowly tilt the outboard motor down.

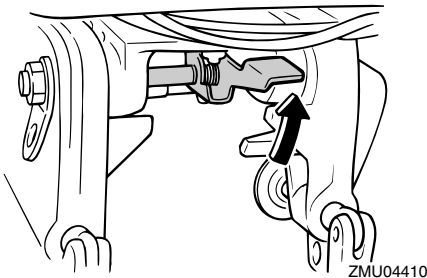

EMU31480

Specifications

NOTE:

“(AL)” stated in the specification data below represents the numerical value for the aluminum propeller installed.

Likewise, “(SUS)” represents the value for stainless steel propeller installed and “(PL)” for plastic propeller installed.

EMU28218

Dimension:

Overall length:

- F9.9ER 575 mm (22.6 in)
- F9.9MH 863 mm (34.0 in)
- T9.9EH 993 mm (39.1 in)
- T9.9ER 575 mm (22.6 in)

Overall width:

- F9.9ER 325 mm (12.8 in)
- F9.9MH 392 mm (15.4 in)
- T9.9EH 430 mm (16.9 in)
- T9.9ER 325 mm (12.8 in)

Overall height S:

- F9.9MH 1004 mm (39.5 in)

Overall height L:

- F9.9ER 1131 mm (44.5 in)
- F9.9MH 1131 mm (44.5 in)
- T9.9EH 1178 mm (46.4 in)
- T9.9ER 1178 mm (46.4 in)

Overall height X:

- T9.9EH 1254 mm (49.4 in)

Transom height S:

- F9.9MH 432 mm (17.0 in)

Transom height L:

- 559 mm (22.0 in)

Transom height X:

- T9.9EH 635 mm (25.0 in)

Weight (AL) S:

- F9.9MH 41.5 kg (91 lb)

Weight (AL) L:

- F9.9ER 44.5 kg (98 lb)

F9.9MH 42.5 kg (94 lb)

T9.9EH 45.0 kg (99 lb)

T9.9ER 45.5 kg (100 lb)

Weight (AL) X:

T9.9EH 45.5 kg (100 lb)

Performance:

Full throttle operating range:

- F9.9ER 4500–5500 r/min
- F9.9MH 4500–5500 r/min
- T9.9EH 4000–5000 r/min
- T9.9ER 4000–5000 r/min

Maximum output:

- F9.9ER 7.3 kW @ 5000 r/min (10 HP @ 5000 r/min)
- F9.9MH 7.3 kW @ 5000 r/min (10 HP @ 5000 r/min)
- T9.9EH 7.3 kW @ 4500 r/min (10 HP @ 4500 r/min)
- T9.9ER 7.3 kW @ 4500 r/min (10 HP @ 4500 r/min)

Idling speed (in neutral):

- F9.9ER 950 ±50 r/min
- F9.9MH 950 ±50 r/min
- T9.9EH 1150 ±50 r/min
- T9.9ER 1150 ±50 r/min

Engine:

Type:

4-stroke L

Displacement:

232.0 cm³ (14.16 cu.in)

Bore × stroke:

59.0 × 42.4 mm (2.32 × 1.67 in)

Ignition system:

CDI

Spark plug with resistor (NGK):

CR6HSA

Spark plug gap:

0.6–0.7 mm (0.024–0.028 in)

Control system:

- F9.9ER Remote control
- F9.9MH Tiller

T9.9EH 21.0 Nm (15.5 ft-lb) (2.14 kgf-m)

T9.9ER 21.0 Nm (15.5 ft-lb) (2.14 kgf-m)

Engine oil drain bolt:

8.0 Nm (5.9 ft-lb) (0.82 kgf-m)

Engine oil filter:

8.0 Nm (5.9 ft-lb) (0.82 kgf-m)

EMU28222

Transporting and storing outboard motor

EWM00690

WARNING

- Leaking fuel is a fire hazard. When transporting and storing the outboard motor, close the air vent screw and fuel cock to prevent fuel from leaking.
- USE CARE when transporting fuel tank, whether in a boat or car.
- DO NOT fill fuel container to maximum capacity. Gasoline will expand considerably as it warms up and can build up pressure in the fuel container. This can cause fuel leakage and a potential fire hazard.

EWM00700

WARNING

Never get under the lower unit while it is tilted, even if a motor support bar is used. Severe injury could occur if the outboard motor accidentally falls.

ECM00660

CAUTION:

Do not use the tilt support lever or knob when trailering the boat. The outboard motor could shake loose from the tilt support and fall. If the motor cannot be trailered in the normal running position, use an additional support device to secure it in the tilt position.

The outboard motor should be trailered and stored in the normal running position. If there is insufficient road clearance in this position, then trailer the outboard motor in the tilt position using a motor support device such as a transom saver bar. Consult your Yamaha dealer for further details.

EMU28235

Clamp screw mounting models

When transporting or storing the outboard motor while removed from a boat, keep the outboard motor in the attitude shown.

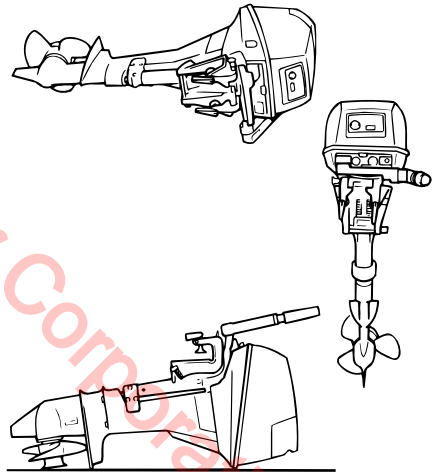

ZMU04411

NOTE:

Place a towel or something similar under the outboard motor to protect it from damage.

EMU28241

Storing outboard motor

When storing your Yamaha outboard motor for prolonged periods of time (2 months or longer), several important procedures must be performed to prevent excessive damage.

Maintenance

It is advisable to have your outboard motor serviced by an authorized Yamaha dealer prior to storage. However, you, the owner, with a minimum of tools, can perform the following procedures.

ECM01080

CAUTION:

- To prevent problems which can be caused by oil entering the cylinder from the sump, keep the outboard motor in the attitude shown when transporting and storing it. If storing or transporting the outboard motor on its side (not upright), put it on a cushion after draining the engine oil.
- Do not place the outboard motor on its side before the cooling water has drained from it completely, otherwise water may enter the cylinder through the exhaust port and cause engine trouble.
- Store the outboard motor in a dry, well-ventilated place, not in direct sunlight.

EMU28303

Procedure

EMU28372

Flushing in a test tank

1. Wash the outboard motor body using fresh water. For further information, see page 45.
2. Fill the fuel tank with fresh fuel and add one ounce of "Yamaha Fuel Conditioner and Stabilizer" (Part No. LUB-FUEL-12-00) to each gallon of fuel.

NOTE:

The use of "Yamaha Fuel Conditioner and Stabilizer" eliminates the need to drain the fuel system. Consult your Yamaha dealer or other qualified mechanic if the fuel system is to be drained instead.

3. Remove the engine top cowling and si-

lencer cover.

4. Install the outboard motor on the test tank.

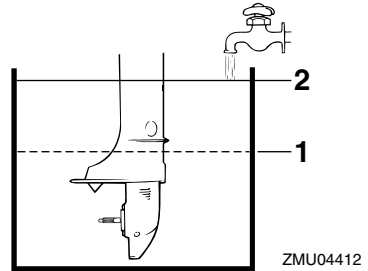

1. Lowest water level
 2. Water surface
5. Fill the tank with fresh water to above the level of the anti-cavitation plate.

ECM00300

CAUTION:

Do not run the engine without supplying it with cooling water. Either the engine water pump will be damaged or the engine will be damaged from overheating. Before starting the engine, be sure to supply water to the cooling water passages.

ECM00290

CAUTION:

If the fresh water level is below the level of the anti-cavitation plate, or if the water supply is insufficient, engine seizure may occur.

6. Cooling system flushing is essential to prevent the cooling system from clogging up with salt, sand, or dirt. In addition, fogging of the engine is mandatory to prevent excessive engine damage due to rust. Perform the flushing and

fogging at the same time.

EWM00090

WARNING

- **Do not touch or remove electrical parts when starting or during operation.**
- **Keep hands, hair, and clothes away from the flywheel and other rotating parts while the engine is running.**

7. Run the engine at a fast idle for 10–15 minutes in neutral position.
8. Just prior to turning off the engine, quickly spray “Yamaha Stor-Rite Engine Fogging Oil” (Part No. LUB-STRRT-12-00) alternately into each carburetor or the fogging hole of the silencer cover, if equipped. When properly done, the engine will smoke excessively and almost stall.
9. Remove the outboard motor from the test tank.
10. Drain the cooling water completely out of the motor. Clean the body thoroughly.
11. Install the silencer cover/cap and top cowling.

EMU28401

Lubrication

1. Grease the spark plug threads and install the spark plug(s) and torque to proper specification. For information on spark plug installation, see page 48.
2. Change the gear oil. For instructions, see page 55. Inspect the oil for the presence of water that indicates a leaky seal. Seal replacement should be performed by an authorized Yamaha dealer prior to use.
3. Grease all grease fittings. For further details, see page 48.

EMU28421

Cleaning and anticorrosion measures

1. Wash down the exterior of the outboard motor with fresh water and dry off completely.
2. Spray the outboard motor exterior with “Yamaha Silicone Protectant” (Part No. LUB-SILCNE-13-00).
3. Wax the cowling with a non-abrasive wax such as “Yamaha Silicone Wax” (Part No. ACC-11000-15-02).

EMU28430

Battery care

EWM00330

WARNING

Battery electrolytic fluid is dangerous; it contains sulfuric acid and therefore is poisonous and highly caustic.

Always follow these preventive measures:

- **Avoid bodily contact with electrolytic fluid as it can cause severe burns or permanent eye injury.**
- **Wear protective eye gear when handling or working near batteries.**

Antidote (EXTERNAL):

- **SKIN - Flush with water.**
- **EYES - Flush with water for 15 minutes and get immediate medical attention.**

Antidote (INTERNAL):

- **Drink large quantities of water or milk followed by milk of magnesia, beaten egg, or vegetable oil. Get immediate medical attention.**

Batteries also generate explosive hydrogen gas; therefore, you should always follow these preventive measures:

- **Charge batteries in a well-ventilated area.**
- **Keep batteries away from fire, sparks, or open flames (for example: welding**

Maintenance

equipment, lighted cigarettes, and so on.)

- **DO NOT SMOKE** when charging or handling batteries.

KEEP BATTERIES AND ELECTROLYTIC FLUID OUT OF REACH OF CHILDREN.

Batteries vary among manufacturers. Therefore the following procedures may not always apply. Consult your battery manufacturer's instructions.

Procedure

1. Disconnect and remove the battery from the boat. Always disconnect the black negative cable first to prevent the risk of shorting.
2. Clean the battery casing and terminals. Fill each cell to the upper level with distilled water.
3. Store the battery on a level surface in a cool, dry, well-ventilated place out of direct sunlight.
4. Once a month, check the specific gravity of the electrolyte and recharge as required to prolong battery life.

EMU28450

Cleaning the outboard motor

After use, wash the exterior of the outboard motor with fresh water. Flush the cooling system with fresh water.

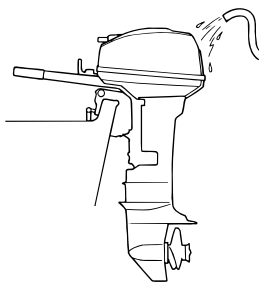

ZMU02871

NOTE:

For cooling system flushing instructions, see

page 42.

EMU28460

Checking painted surface of motor

Check the motor for scratches, nicks, or flaking paint. Areas with damaged paint are more likely to corrode. If necessary, clean and paint the areas. A touch-up paint is available from your Yamaha dealer.

EMU28486

Periodic maintenance

EWM01070



WARNING

Be sure to turn off the engine when you perform maintenance unless otherwise specified. If you or the owner is not familiar with machine servicing, this work should be done by your Yamaha dealer or other qualified mechanic.

Maintenance, replacement, or repair of the emission control devices and systems may be performed by any marine engine repair establishment or individual. All warranty repairs, however, including those to the emission control system, must be performed by an authorized Yamaha marine dealership.

A service manual is available for purchase through your Yamaha dealer for owners who have the mechanical skills, tools, and other equipment necessary to perform maintenance not covered by this owner's manual.

EMU28510

Replacement parts

If replacement parts are necessary, use only genuine Yamaha parts or parts of the same type and of equivalent strength and materials. Any part of inferior quality may malfunction, and the resulting loss of control could endanger the operator and passengers. Yamaha genuine parts and accessories are available from your Yamaha dealer.

EMU28522

Maintenance chart

Frequency of maintenance operations may be adjusted according to the operating conditions, but the following table gives general guidelines. Refer to the sections in this chapter for explanations of each owner-specific action.

NOTE:

When operating in salt water, turbid or muddy water, the engine should be flushed with clean water after each use.

The “●” symbol indicates the check-ups which you may carry out yourself.

The “○” symbol indicates work to be carried out by your Yamaha dealer.

Item	Actions	Initial		Every	
		10 hours (1 month)	50 hours (3 months)	100 hours (6 months)	200 hours (1 year)
Anode(s) (external)	Inspection / replacement		●/○	●/○	
Anode(s) (internal)	Inspection / replacement				○
Battery	Inspection / charging	●/○			
Cooling water passages	Cleaning		●	●	
Cowling clamp	Inspection				●
Fuel filter (disposable)	Inspection / replacement	●/○	●/○	●/○	
Fuel system	Inspection	●	●	●	
Fuel tank (Yamaha portable tank)	Inspection / cleaning				●
Gear oil	Change	●		●	
Greasing points	Greasing			●	
Idling speed (carburetor models)	Inspection	●/○		●/○	
Propeller and cotter pin	Inspection / replacement		●	●	
Shift link / shift cable	Inspection / adjustment				○
Thermostat	Inspection / replacement				○
Throttle link / throttle cable / throttle pick-up timing	Inspection / adjustment				○
Water pump	Inspection / replacement				○

Maintenance

Item	Actions	Initial		Every	
		10 hours (1 month)	50 hours (3 months)	100 hours (6 months)	200 hours (1 year)
Engine oil	Inspection / change	●		●	
Oil filter (built into oil pan)	Inspection / cleaning / change				○
Spark plug(s)	Cleaning / adjustment / replacement	●			●
Timing belt	Inspection / replacement			○	○
Valve clearance (OHC, OHV)	Inspection / adjustment	○		○	

EMU28874

Maintenance chart (additional)

Item	Actions	Every	
		500 hours (2.5 years)	1000 hours (5 years)
Timing belt	Replacement		○
Exhaust guide, exhaust manifold	Inspection / replacement		○

EMU28910

NOTE:

When using lead or high-sulfur gasoline, inspecting valve clearance may be required more frequently than every 500 hours.

EMU28931

Greasing

Yamaha marine grease (Water resistant grease)

F9.9, T9.9

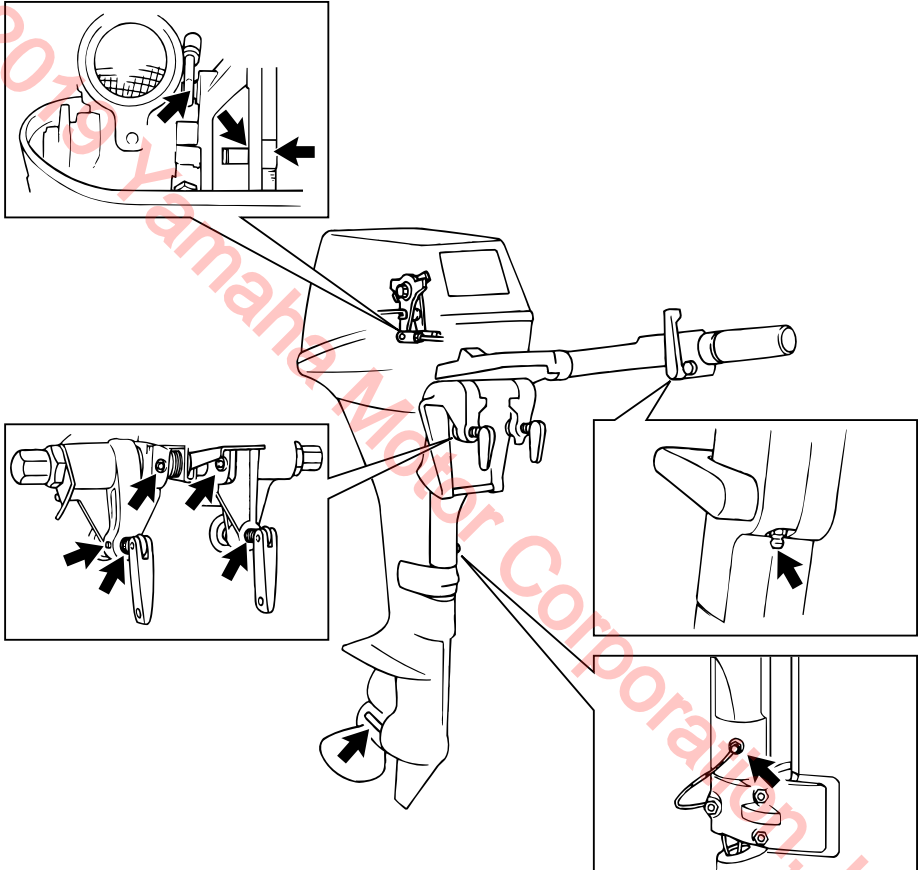

ZMU04413

EMU28952

Cleaning and adjusting spark plug

EWM00560



When removing or installing a spark plug, be careful not to damage the insulator. A damaged insulator could allow external

sparks, which could lead to explosion or fire.

The spark plug is an important engine component and is easy to inspect. The condition of the spark plug can indicate something about the condition of the engine. For exam-

Maintenance

ple, if the center electrode porcelain is very white, this could indicate an intake air leak or carburetion problem in that cylinder. Do not attempt to diagnose any problems yourself. Instead, take the outboard motor to a Yamaha dealer. You should periodically remove and inspect the spark plug because heat and deposits will cause the spark plug to slowly break down and erode. If electrode erosion becomes excessive, or if carbon and other deposits are excessive, you should replace the spark plug with another of the correct type.

Standard spark plug:
CR6HSA

Before fitting the spark plug, measure the electrode gap with a wire thickness gauge; adjust the gap to specification if necessary.

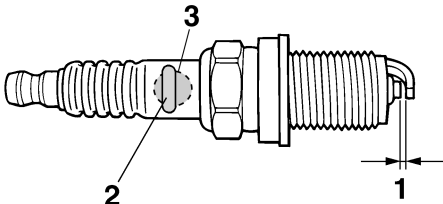

ZMU01797

1. Spark plug gap
2. Spark plug I.D. mark (NGK)
3. Spark plug part number

Spark plug gap:
0.6–0.7 mm (0.024–0.028 in)

When fitting the plug, always clean the gasket surface and use a new gasket. Wipe off any dirt from the threads and screw in the

spark plug to the correct torque.

Spark plug torque:
13.0 Nm (9.6 ft-lb) (1.33 kgf-m)

NOTE:

If a torque-wrench is not available when you are fitting a spark plug, a good estimate of the correct torque is 1/4 to 1/2 a turn past finger-tight. Have the spark plug adjusted to the correct torque as soon as possible with a torque-wrench.

EMU28962

Checking fuel system

EWM00060

WARNING

Gasoline and its vapors are highly flammable and explosive. Keep away from sparks, cigarettes, flames, or other sources of ignition.

EWM00910

WARNING

Leaking fuel can result in fire or explosion.

- Check for fuel leakage regularly.
- If any fuel leakage is found, the fuel system must be repaired by a qualified mechanic. Improper repairs can make the outboard unsafe to operate.

Check the fuel lines for leaks, crack, or malfunction. If a problem is found, your Yamaha dealer or other qualified mechanic should repair it immediately.

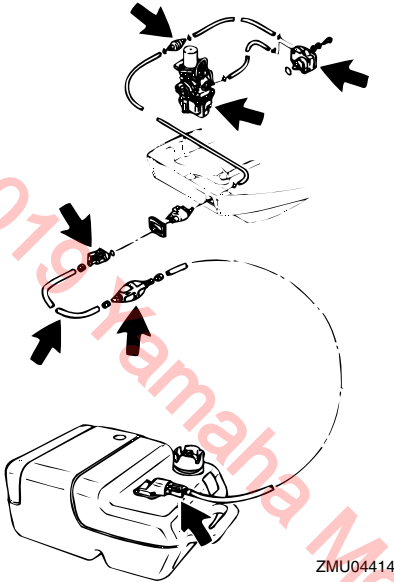

Checkpoints

- Fuel system parts leakage
- Fuel line joint leakage
- Fuel line cracks or other damage
- Fuel connector leakage

EMU28990

Checking fuel filter

Check the fuel filter periodically. The fuel filter is a one piece, disposable type. If foreign matter is found in the filter, replace it. For replacement of the fuel filter, consult your Yamaha dealer.

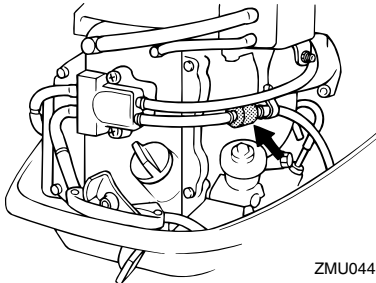

EMU29041

Inspecting idling speed

EWM00451

WARNING

- Do not touch or remove electrical parts when starting or during operation.
- Keep hands, hair, and clothes away from the flywheel and other rotating parts while the engine is running.

ECM00490

CAUTION:

This procedure must be performed while the outboard motor is in the water. A flushing attachment or test tank can be used.

A diagnostic tachometer should be used for this procedure. Results may vary depending on whether testing is conducted with the flushing attachment, in a test tank, or with the outboard motor in the water.

1. Start the engine and allow it to warm up fully in neutral until it is running smoothly.

NOTE:

Correct idling speed inspection is only possible if the engine is fully warmed up. If not warmed up fully, the idle speed will measure higher than normal. If you have difficulty verifying the idle speed, or the idle speed requires adjustment, consult a Yamaha dealer or other qualified mechanic.

2. Verify whether the idle speed is set to specification. For idle speed specifications, see page 40.

EMU29093

Changing engine oil

EWM00760

WARNING

- Avoid draining the engine oil immediately after stopping the engine. The oil

Maintenance

is hot and should be handled with care to avoid burns.

- Be sure the outboard motor is securely fastened to the transom or a stable stand.

ECM01240

CAUTION:

Change the engine oil after the first 10 hours of operation, and every 100 hours or at 6-month intervals thereafter. Otherwise the engine will wear quickly.

NOTE:

Change the engine oil when the oil is still warm.

1. Put the outboard motor in an upright position (not tilted).

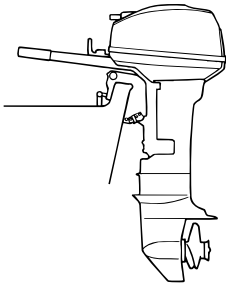

ZMU04416

2. Prepare a suitable container that holds a larger amount than the engine oil capacity. Loosen and remove the drain screw while holding the container under the drain hole. Then remove the oil filler cap. Let the oil drain completely. Wipe up any spilled oil immediately.

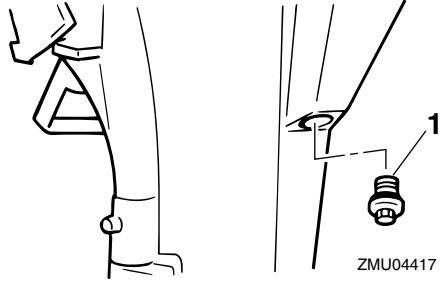

ZMU04417

1. Drain screw

Drain screw tightening torque:
8.0 Nm (5.9 ft-lb) (0.82 kgf-m)

3. Put a new gasket on the oil drain screw. Apply a light coat of oil to the gasket and install the drain screw.

NOTE:

If a torque wrench is not available when you are installing the drain screw, finger tighten the screw just until the gasket comes into contact with the surface of the drain hole. Then tighten 1/4 to 1/2 turn more. Tighten the drain screw to the correct torque with a torque wrench as soon as possible.

4. Add the correct amount of oil through the filler hole. Install the filler cap.

Recommended engine oil:
4-stroke outboard motor oil
Engine oil quantity (excluding oil filter):
1.0 L (1.06 US qt) (0.88 Imp.qt)

ECM00970

CAUTION:

- Do not overfill the oil, and be sure the outboard motor is upright (not tilted) when checking and changing the engine oil.
- If the oil level is above the upper level

mark, drain until the level meets the specified capacity. Overfilling the oil could cause leakage or damage.

5. Start the engine and watch to make sure the oil pressure indicator turns on. Make sure that there are no oil leaks.

ECM01420

CAUTION:

If the oil pressure indicator does not turn on, or if there are oil leaks, stop the engine and find the cause. Continued operation with a problem could cause severe engine damage. Consult your Yamaha dealer if the problem cannot be located and corrected.

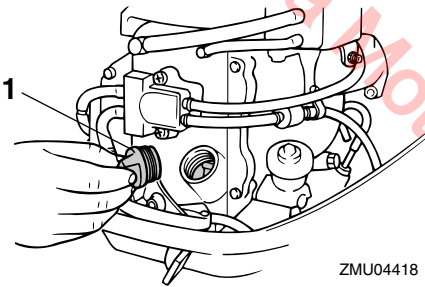

ZMU04418

1. Oil filler cap
6. Turn off the engine and wait 3 minutes. Recheck the oil level using the dipstick to be sure the level falls between the upper and lower marks. Fill with oil if it is below the lower mark, or drain to the specified level if it is above the upper mark.

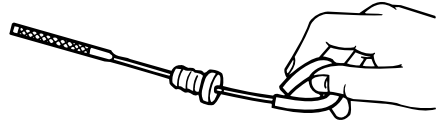

ZMU02058

7. Dispose of used oil according to local regulations.

NOTE:

- For more information on the disposal of used oil, consult your Yamaha dealer.
- Change the oil more often when operating the engine under adverse conditions such as extended trolling.

EMU29112

Checking wiring and connectors

- Check that each grounding wire is properly secured.
- Check that each connector is engaged securely.

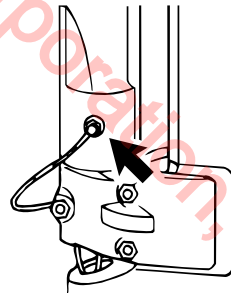

ZMU04419

EMU29120

Exhaust leakage

Start the engine and check that no exhaust leaks from the joints between the exhaust cover, cylinder head, and body cylinder.

Maintenance

EMU29130

Water leakage

Start the engine and check that no water leaks from the joints between the exhaust cover, cylinder head, and body cylinder.

EMU29140

Engine oil leakage

Check for oil leaks on the around the engine.

NOTE:

If any leaks are found, consult your Yamaha dealer.

EMU29171

Checking propeller

EWM00321

WARNING

You could be seriously injured if the engine accidentally starts when you are near the propeller.

- Before inspecting, removing, or installing the propeller, remove the spark plug caps from the spark plugs. Also, place the shift control in neutral, turn the main switch to "OFF" (off) and remove the key, and remove the lanyard from the engine stop switch. Turn off the battery cut-off switch if your boat has one.
- Do not use your hand to hold the propeller when loosening or tightening the propeller nut. Put a wood block between the anti-cavitation plate and the propeller to prevent the propeller from turning.

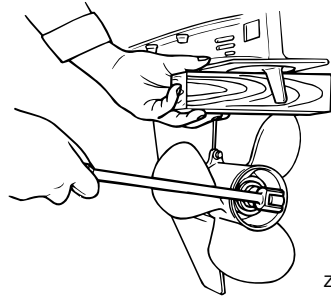
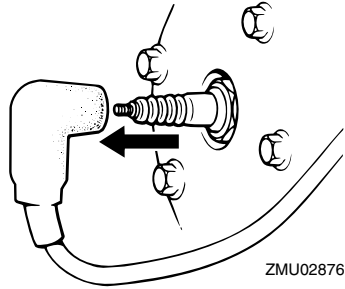

Checkpoints

- Check each of the propeller blades for wear, erosion from cavitation or ventilation, or other damage.
- Check the propeller shaft for damage.
- Check the splines / shear pin for wear or damage.
- Check for fish line tangled around the propeller shaft.

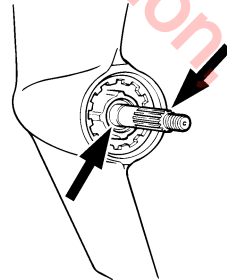

- Check the propeller shaft oil seal for damage.

NOTE:

If the shear pin equipped: it is designed to break if the propeller hits a hard underwater obstacle to help protect the propeller and drive mechanism. The propeller will then spin freely on the shaft. If this happens, the shear pin must be replaced.

EMU30660

Removing the propeller

EMU29194

Spline models

1. Straighten the cotter pin and pull it out using a pair of pliers.
2. Remove the propeller nut, washer, and spacer (if equipped).

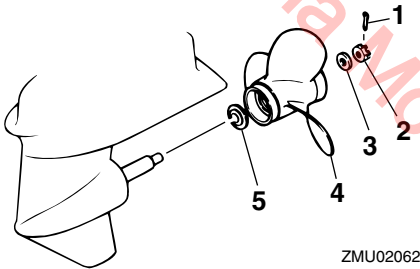

1. Cotter pin
2. Propeller nut
3. Washer
4. Propeller
5. Thrust washer

3. Remove the propeller and thrust washer.

EMU29212

Dual thrust models

1. Straighten the cotter pin and pull it out using a pair of pliers.

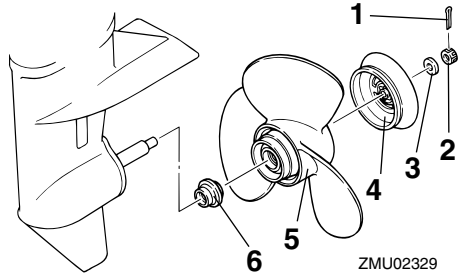

1. Cotter pin
2. Propeller nut
3. Washer
4. Deflector
5. Propeller
6. Thrust washer

2. Remove the propeller nut and washer.
3. Remove the deflector, propeller, and thrust washer.

EMU30670

Installing the Propeller

EMU29231

Spline models

ECM00340

CAUTION:

- Be sure to install the thrust washer before installing the propeller, otherwise the lower case and propeller boss could be damaged.
- Be sure to use a new cotter pin and bend the ends over securely. Otherwise the propeller could come off during operation and be lost.

1. Apply Yamaha marine grease or a corrosion resistant grease to the propeller shaft.
2. Install the spacer (if equipped), thrust washer, and propeller on the propeller shaft.
3. Install the spacer (if equipped) and the washer. Tighten the propeller nut to the

Maintenance

specified torque.

- Align the propeller nut with the propeller shaft hole. Insert a new cotter pin in the hole and bend the cotter pin ends.

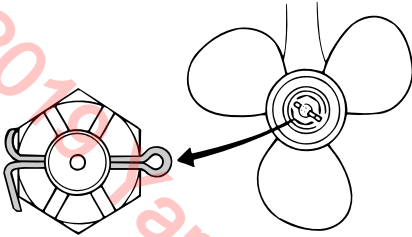

ZMU02063

NOTE:

If the propeller nut does not align with the propeller shaft hole after tightening to the specified torque, tighten the nut further to align it with the hole.

EMU29262

Dual thrust models

ECM00340

CAUTION:

- Be sure to install the thrust washer before installing the propeller, otherwise the lower case and propeller boss could be damaged.
- Be sure to use a new cotter pin and bend the ends over securely. Otherwise the propeller could come off during operation and be lost.

- Apply Yamaha marine grease or a corrosion resistant grease to the propeller shaft.
- Install the thrust washer and propeller on the propeller shaft. Install the deflector on the propeller.
- Install the washer and tighten the propeller nut to the specified torque.
- Align the propeller nut with the propeller

shaft hole. Insert a new cotter pin in the hole and bend the cotter pin ends.

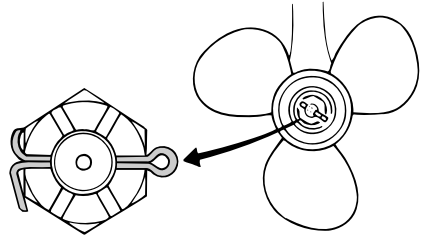

ZMU02063

NOTE:

If the propeller nut does not align with the propeller shaft hole after tightening to the specified torque, tighten the nut further to align it with the hole.

EMU29282

Changing gear oil

EWM00800

WARNING

- Be sure the outboard motor is securely fastened to the transom or a stable stand. You could be severely injured if the outboard motor falls on you.
- Never get under the lower unit while it is tilted, even when the tilt support lever or knob is locked. Severe injury could occur if the outboard motor accidentally falls.

- Tilt the outboard motor so that the gear oil drain screw is at the lowest point possible.
- Place a suitable container under the gear case.
- Remove the gear oil drain screw and gasket.

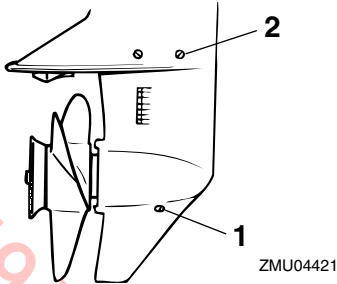

1. Gear oil drain screw
2. Oil level plug

NOTE:

- If a magnetic gear oil drain screw is equipped, remove all metal particles from the screw before installing it.
 - Always use new gaskets. Do not reuse the removed gaskets.
4. Remove the oil level plug and gasket to allow the oil to drain completely.

ECM00710

CAUTION:

Inspect the used oil after it has been drained. If the oil is milky, water is getting into the gear case which can cause gear damage. Consult a Yamaha dealer for repair of the lower unit seals.

NOTE:

For disposal of used oil, consult your Yamaha dealer.

5. With the outboard motor in a vertical position, and using a flexible or pressurized filling device, inject the gear oil into

the gear oil drain screw hole.

Recommended gear oil:

Hypoid gear oil SAE#90

Gear oil quantity:

F9.9ER 185.0 cm³ (6.25 US oz) (6.52 Imp.oz)

F9.9MH 185.0 cm³ (6.25 US oz) (6.52 Imp.oz)

T9.9EH 320.0 cm³ (10.82 US oz) (11.29 Imp.oz)

T9.9ER 320.0 cm³ (10.82 US oz) (11.29 Imp.oz)

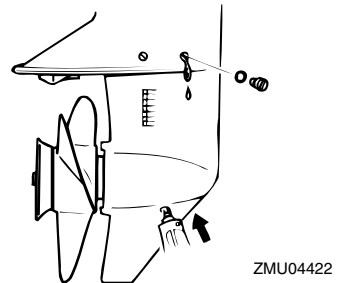

6. Put a new gasket on the oil level plug. When the oil begins to flow out of the oil level plug hole, insert and tighten the oil level plug.
7. Put a new gasket on the gear oil drain screw. Insert and tighten the gear oil drain screw.

EMU29302

Cleaning fuel tank

EWWM00920

WARNING

Gasoline is highly flammable, and its vapors are flammable and explosive.

- If you have any question about properly doing this procedure, consult your Yamaha dealer.
- Keep away from sparks, cigarettes, flames, or other sources of ignition

Maintenance

when cleaning the fuel tank.

- Remove the fuel tank from the boat before cleaning it. Work only outdoors in an area with good ventilation.
- Wipe up any spilled fuel immediately.
- Reassemble the fuel tank carefully. Improper assembly can result in a fuel leak, which could result in a fire or explosion hazard.
- Dispose of old gasoline according to local regulations.

1. Empty the fuel tank into an approved container.
2. Pour a small amount of suitable solvent into the tank. Install the cap and shake the tank. Drain the solvent completely.
3. Remove the screws holding the fuel joint assembly. Pull the assembly out of the tank.

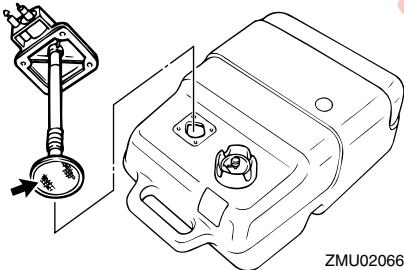

4. Clean the filter (located on the end of the suction pipe) in a suitable cleaning solvent. Allow the filter to dry.
5. Replace the gasket with a new one. Reinstall the fuel joint assembly and tighten the screws firmly.

EMU29312

Inspecting and replacing anode(s)

Yamaha outboard motors are protected from corrosion by sacrificial anodes. Inspect the external anodes periodically. Remove scales from the surfaces of the anodes. Consult a

Yamaha dealer for replacement of external anodes.

ECM00720

CAUTION:

Do not paint anodes, as this would render them ineffective.

NOTE:

Inspect ground leads attached to external anodes on equipped models. Consult a Yamaha dealer for inspection and replacement of internal anodes attached to the power unit.

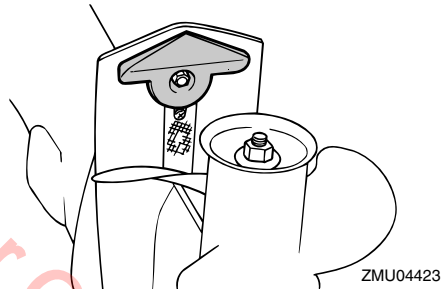

EMU29320

Checking battery (for electric start models)

EWM00330

WARNING

Battery electrolytic fluid is dangerous; it contains sulfuric acid and therefore is poisonous and highly caustic.

Always follow these preventive measures:

- Avoid bodily contact with electrolytic fluid as it can cause severe burns or permanent eye injury.
- Wear protective eye gear when handling or working near batteries.

Antidote (EXTERNAL):

- SKIN - Flush with water.
- EYES - Flush with water for 15 minutes

and get immediate medical attention.

Antidote (INTERNAL):

- Drink large quantities of water or milk followed by milk of magnesia, beaten egg, or vegetable oil. Get immediate medical attention.

Batteries also generate explosive hydrogen gas; therefore, you should always follow these preventive measures:

- Charge batteries in a well-ventilated area.
- Keep batteries away from fire, sparks, or open flames (for example: welding equipment, lighted cigarettes, and so on.)
- **DO NOT SMOKE** when charging or handling batteries.

KEEP BATTERIES AND ELECTROLYTIC FLUID OUT OF REACH OF CHILDREN.

ECM00360

CAUTION:

- A poorly maintained battery will quickly deteriorate.
- Ordinary tap water contains minerals harmful to a battery, and should not be used for topping up.

1. Check the electrolyte level at least once a month. Fill to the manufacturer's recommended level when necessary. Top up only with distilled water (or pure de-ionized water suitable to use in batteries).

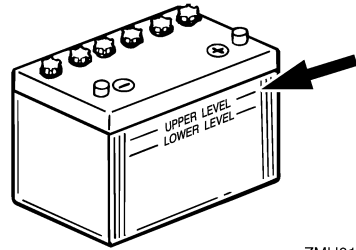

ZMU01810

2. Always keep the battery in a good state of charge. Installing a voltmeter will help you monitor your battery. If you will not use the boat for a month or more, remove the battery from the boat and store it in a cool, dark place. Completely recharge the battery before using it.
3. If the battery will be stored for longer than a month, check the specific gravity of the fluid at least once a month and recharge the battery when it is low.

NOTE:

Consult a Yamaha dealer when charging or re-charging batteries.

EMU29331

Connecting the battery

EWM00570



Mount the battery holder securely in a dry, well-ventilated, vibration-free location in the boat. Install a fully charged battery in the holder.

ECM01121

CAUTION:

- Make sure the main switch (on applicable models) is "OFF" (off) before working on the battery.
- Reversal of the battery cables will damage the electrical parts.
- Connect the red battery cable first

Maintenance

when installing the battery and disconnect the black battery cable first when removing it. Otherwise, the electrical parts can be damaged.

- The electrical contacts of the battery and cables must be clean and properly connected, or the battery will not start the engine.

Connect the red battery cable to the POSITIVE (+) terminal first. Then connect the black battery cable to the NEGATIVE (-) terminal.

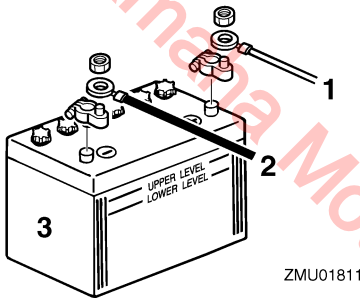

1. Red cable
2. Black cable
3. Battery

EMU29370

Disconnecting the battery

Disconnect the BLACK cable from the NEGATIVE (-) terminal first. Then disconnect the RED cable from the POSITIVE (+) terminal.

EMU29380

Charging battery

If an accessory battery charging is required, precede the following steps for connecting the charging circuit to the battery. The charge leads and fuse holder for making the circuit are provided in the packing.

1. Remove the top cowling and remove the CDI unit cover.

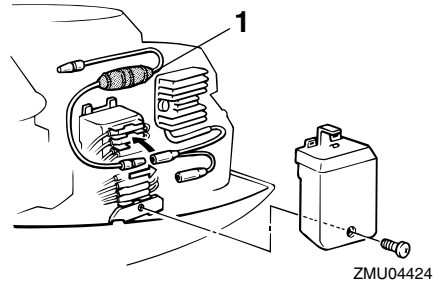

1. Fuse holder
2. Connect one of the fuse holder terminals to the red free terminal fixed with the red lead from the rectifier regulator.

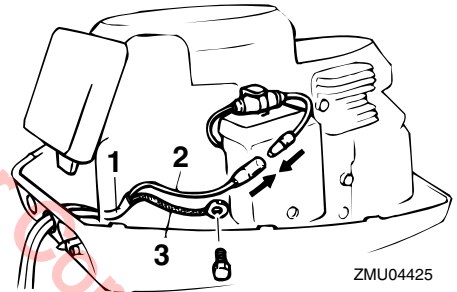

1. Charge lead
2. Red lead
3. Black lead
3. Reinstall the CDI unit cover and fit the fuse holder onto the top side of the cover.
4. Connect the other fuse holder terminal to the red terminal of the charge lead. Secure the black terminal (ground) of the charge lead to the engine, together with the CDI unit ground terminal.
5. Pull out the charge lead through the grommet on the port and front side of the bottom cowling.
6. To connect the cables to the battery, see

page 57 for the correct procedure.

EMU29390

Checking top cowling

Check the fitting of the top cowling by pushing it with both hands. If it is loose have it repaired by your Yamaha dealer.

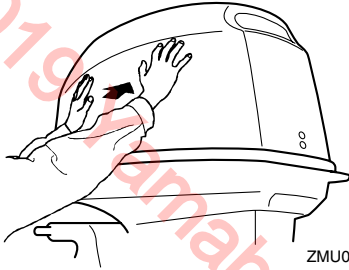

ZMU02068

EMU29400

Coating the boat bottom

A clean hull improves boat performance. The boat bottom should be kept as clean of marine growth as possible. If necessary, the boat bottom can be coated with an anti-fouling paint approved for your area to inhibit marine growth.

Do not use anti-fouling paint which includes copper or graphite. These paints can cause more rapid engine corrosion.

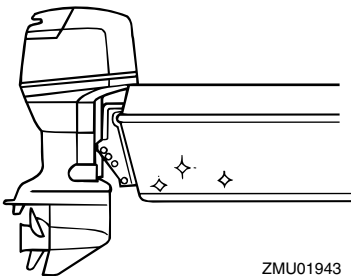

ZMU01943

Trouble Recovery

EMU29424

Troubleshooting

A problem in the fuel, compression, or ignition systems can cause poor starting, loss of power, or other problems. This section describes basic checks and possible remedies, and covers all Yamaha outboard motors. Therefore some items may not apply to your model.

If your outboard motor requires repair, bring it to your Yamaha dealer.

If the engine trouble warning indicator is flashing, consult your Yamaha dealer.

Starter will not operate.

Q. Is battery capacity weak or low?

A. Check battery condition. Use battery of recommended capacity.

Q. Are battery connections loose or corroded?

A. Tighten battery cables and clean battery terminals.

Q. Is fuse for electric start relay or electric circuit blown?

A. Check for cause of electric overload and repair. Replace fuse with one of correct amperage.

Q. Are starter components faulty?

A. Have serviced by a Yamaha dealer.

Q. Is shift lever in gear?

A. Shift to neutral.

Engine will not start (starter operates).

Q. Is fuel tank empty?

A. Fill tank with clean, fresh fuel.

Q. Is fuel contaminated or stale?

A. Fill tank with clean, fresh fuel.

Q. Is fuel filter clogged?

A. Clean or replace filter.

Q. Is starting procedure incorrect?

A. See page 27.

Q. Has fuel pump malfunctioned?

A. Have serviced by a Yamaha dealer.

Q. Are spark plug(s) fouled or of incorrect type?

A. Inspect spark plug(s). Clean or replace with recommended type.

Q. Are spark plug cap(s) fitted incorrectly?

A. Check and re-fit cap(s).

Q. Is ignition wiring damaged or poorly connected?

A. Check wires for wear or breaks. Tighten all loose connections. Replace worn or broken wires.

Q. Are ignition parts faulty?

A. Have serviced by a Yamaha dealer.

Q. Is engine stop switch lanyard not attached?

A. Attach lanyard.

Q. Are engine inner parts damaged?

A. Have serviced by a Yamaha dealer.

Engine idles irregularly or stalls.

Q. Are spark plug(s) fouled or of incorrect type?

A. Inspect spark plug(s). Clean or replace with recommended type.

Trouble Recovery

Q. Is fuel system obstructed?

A. Check for pinched or kinked fuel line or other obstructions in fuel system.

Q. Is fuel contaminated or stale?

A. Fill tank with clean, fresh fuel.

Q. Is fuel filter clogged?

A. Clean or replace filter.

Q. Have ignition parts failed?

A. Have serviced by a Yamaha dealer.

Q. Has warning system activated?

A. Find and correct cause of warning.

Q. Is spark plug gap incorrect?

A. Inspect and adjust as specified.

Q. Is ignition wiring damaged or poorly connected?

A. Check wires for wear or breaks. Tighten all loose connections. Replace worn or broken wires.

Q. Is specified engine oil not being used?

A. Check and replace oil as specified.

Q. Is thermostat faulty or clogged?

A. Have serviced by a Yamaha dealer.

Q. Are carburetor adjustments incorrect?

A. Have serviced by a Yamaha dealer.

Q. Is fuel pump damaged?

A. Have serviced by a Yamaha dealer.

Q. Is air vent screw on fuel tank closed?

A. Open air vent screw.

Q. Is choke knob pulled out?

A. Return to home position.

Q. Is motor angle too high?

A. Return to normal operating position.

Q. Is carburetor clogged?

A. Have serviced by a Yamaha dealer.

Q. Is fuel joint connection incorrect?

A. Connect correctly.

Q. Is throttle valve adjustment incorrect?

A. Have serviced by a Yamaha dealer.

Q. Is battery cable disconnected?

A. Connect securely.

Warning buzzer sounds or indicator lights.

Q. Is cooling system clogged?

A. Check water intake for restriction.

Q. Is engine oil level low?

A. Fill oil tank with specified engine oil.

Q. Is heat range of spark plug incorrect?

A. Inspect spark plug and replace it with recommended type.

Q. Is specified engine oil not being used?

A. Check and replace oil with specified type.

Q. Is engine oil contaminated or deteriorated?

A. Replace oil with fresh, specified type.

Q. Is oil filter clogged?

A. Have serviced by a Yamaha dealer.

Q. Has oil feed/injection pump malfunctioned?

Trouble Recovery

A. Have serviced by a Yamaha dealer.

Q. Is load on boat improperly distributed?

A. Distribute load to place boat on an even plane.

Q. Is water pump or thermostat faulty?

A. Have serviced by a Yamaha dealer.

Q. Is there excess water in fuel filter cup?

A. Drain filter cup.

Engine power loss.

Q. Is propeller damaged?

A. Have propeller repaired or replaced.

Q. Is propeller pitch or diameter incorrect?

A. Install correct propeller to operate outboard at its recommended speed (r/min) range.

Q. Is trim angle incorrect?

A. Adjust trim angle to achieve most efficient operation.

Q. Is motor mounted at incorrect height on transom?

A. Have motor adjusted to proper transom height.

Q. Has warning system activated?

A. Find and correct cause of warning.

Q. Is boat bottom fouled with marine growth?

A. Clean boat bottom.

Q. Are spark plug(s) fouled or of incorrect type?

A. Inspect spark plug(s). Clean or replace with recommended type.

Q. Are weeds or other foreign matter tangled on gear housing?

A. Remove foreign matter and clean lower unit.

Q. Is fuel system obstructed?

A. Check for pinched or kinked fuel line or other obstructions in fuel system.

Q. Is fuel filter clogged?

A. Clean or replace filter.

Q. Is fuel contaminated or stale?

A. Fill tank with clean, fresh fuel.

Q. Is spark plug gap incorrect?

A. Inspect and adjust as specified.

Q. Is ignition wiring damaged or poorly connected?

A. Check wires for wear or breaks. Tighten all loose connections. Replace worn or broken wires.

Q. Have electrical parts failed?

A. Have serviced by a Yamaha dealer.

Q. Is specified fuel not being used?

A. Replace fuel with specified type.

Q. Is specified engine oil not being used?

A. Check and replace oil with specified type.

Q. Is thermostat faulty or clogged?

A. Have serviced by a Yamaha dealer.

Q. Is air vent screw closed?

A. Open the air vent screw.

Q. Is fuel pump damaged?

A. Have serviced by a Yamaha dealer.

Trouble Recovery

Q. Is fuel joint connection incorrect?

A. Connect correctly.

Q. Is heat range of spark plug incorrect?

A. Inspect spark plug and replace it with recommended type.

Q. Is high pressure fuel pump drive belt broken?

A. Have serviced by a Yamaha dealer.

Q. Is engine not responding properly to shift lever position?

A. Have serviced by a Yamaha dealer.

Engine vibrates excessively.

Q. Is propeller damaged?

A. Have propeller repaired or replaced.

Q. Is propeller shaft damaged?

A. Have serviced by a Yamaha dealer.

Q. Are weeds or other foreign matter tangled on propeller?

A. Remove and clean propeller.

Q. Is motor mounting bolt loose?

A. Tighten bolt.

Q. Is steering pivot loose or damaged?

A. Tighten or have serviced by a Yamaha dealer.

EMU29433

Temporary action in emergency

EMU29440

Impact damage

EWM00870



The outboard motor can be seriously

damaged by a collision while operating or trailering. Damage could make the outboard motor unsafe to operate.

If the outboard motor hits an object in the water, follow the procedure below.



1. Stop the engine immediately.
2. Inspect the control system and all components for damage. Also inspect the boat for damage.
3. Whether damage is found or not, return to the nearest harbor slowly and carefully.
4. Have a Yamaha dealer inspect the outboard motor before operating it again.

EMU29462

Replacing fuse

If the fuse has blown on an electric start model, open the fuse holder and replace the fuse with a new one of the proper amperage.

EWM00630



Be sure to use the specified fuse. An incorrect fuse or a piece of wire could allow excessive current flow. This could cause electric system damage and a fire hazard.

Trouble Recovery

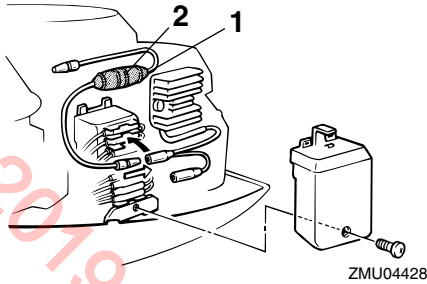

1. Fuse holder
2. Fuse (20 A)

NOTE:

Consult your Yamaha dealer if the new fuse immediately blows again.

EMU29532

Starter will not operate

If the starter mechanism does not operate (the engine cannot be cranked with the starter), the engine can be started with an emergency starter rope.

EWM01021

⚠ WARNING

- Use this procedure only in an emergency to return to the nearest port for repairs.
- When the emergency starter rope is used to start the engine, the start-in-gear protection device does not operate. Make sure the remote control lever is in neutral. Otherwise the boat could unexpectedly start to move, which could result in an accident.
- Attach the engine stop switch lanyard to a secure place on your clothing, or your arm or leg while operating the boat.
- Do not attach the lanyard to clothing that could tear loose. Do not route the cord where it could become entangled,

preventing it from functioning.

- Avoid accidentally pulling the lanyard during normal operation. Loss of engine power means the loss of most steering control. Also, without engine power, the boat could slow rapidly. This could cause people and objects in the boat to be thrown forward.
- Make sure no one is standing behind you when pulling the starter rope. It could whip behind you and injure someone.
- An unguarded, rotating flywheel is very dangerous. Keep loose clothing and other objects away when starting the engine. Use the emergency starter rope only as instructed. Do not touch the flywheel or other moving parts when the engine is running. Do not install the starter mechanism or top cowling after the engine is running.
- Do not touch the ignition coil, spark plug wire, spark plug cap, or other electrical components when starting or operating the motor. You could get an electrical shock.

EMU29651

Emergency starting engine

1. Remove the top cowling.
2. Temporarily pull out the lock pin, loosen the bolt, then remove the flywheel cover.

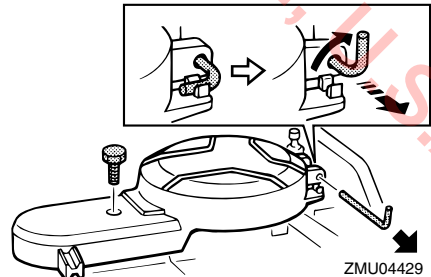

ZMU04429

Trouble Recovery

3. Lock the front panel with the lock pin.
4. Prepare the engine for starting. For further information, see page 27. Be sure the engine is in neutral and that the engine stop switch lanyard lock plate is attached to the engine stop switch. The main switch must be "ON" (on), if equipped.

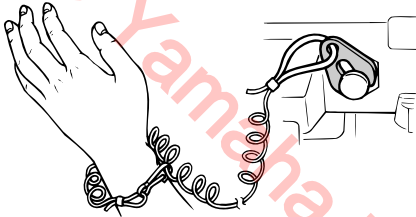

ZMU04445

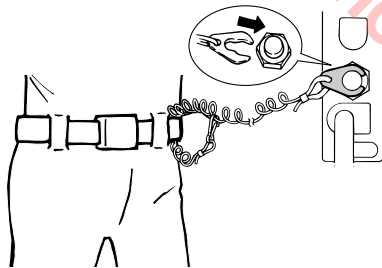

ZMU02334

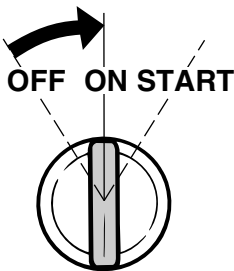

ZMU01906

dures.

5. Insert the knotted end of the emergency starter rope into the notch in the flywheel rotor and wind the rope several turns around the flywheel clockwise.
6. Pull the rope slowly until resistance is felt.
7. Give a strong pull straight out to crank and start the engine. Repeat if necessary.

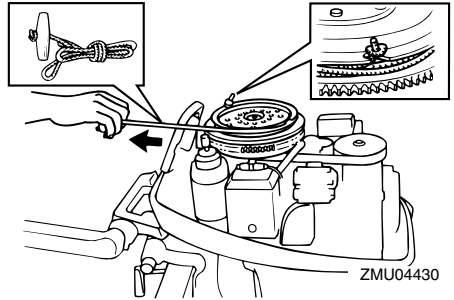

ZMU04430

EMU29670

Engine fails to operate

EMU29711

Cold engine fails to start

1. Place the gear shift lever or remote control lever in neutral.

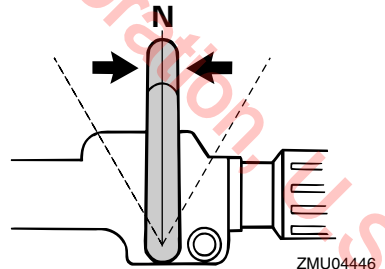

ZMU04446

NOTE:

See page 66 for cold engine starting procedure.

Trouble Recovery

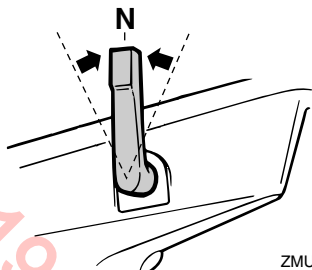

ZMU04451

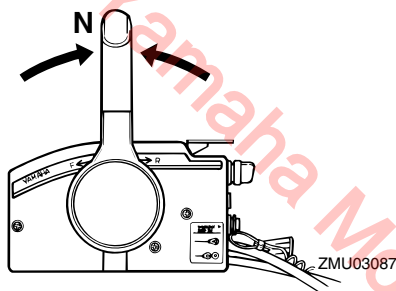

ZMU03087

2. Open the throttle halfway. On models with a neutral throttle limiter, open the throttle as far as it will go.
3. Start the engine.
4. If the engine still will not start, open and close the throttle two or three times to feed additional fuel to the intake manifold by operating the accelerator pump of the carburetor.
5. Open the throttle halfway and start the engine again.

EMU29760

Treatment of submerged motor

If the outboard motor is submerged, immediately take it to a Yamaha dealer. Otherwise some corrosion may begin almost immediately.

If you cannot immediately take the outboard motor to a Yamaha dealer, follow the procedure below in order to minimize engine damage.

EMU29783

Procedure

1. Thoroughly wash away mud, salt, seaweed, and so on, with fresh water.

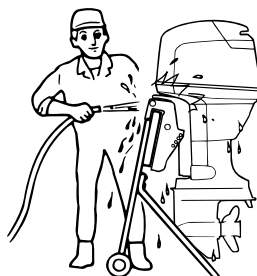

ZMU02075

2. Remove the spark plug(s), then face the spark plug holes downward to allow any water, mud, or contaminants to drain.

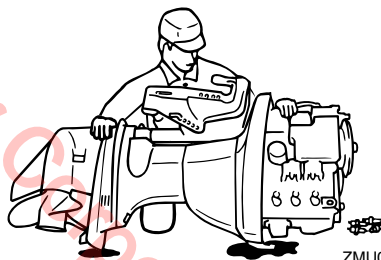

ZMU02076

3. Drain the fuel from the carburetor, fuel filter, and fuel line. Drain the engine oil completely.
4. Fill the sump with the fresh engine oil.

Engine oil capacity:

1.0 L (1.06 US qt) (0.88 Imp. qt)

5. Feed engine fogging oil or engine oil through the carburetor(s) and spark plug holes while cranking the engine with the manual starter or emergency starter rope.
6. Take the outboard motor to a Yamaha

dealer as soon as possible.

ECM00400

CAUTION: _____

**Do not attempt to run the outboard motor
until it has been completely inspected.**

©2019 Yamaha Motor Corporation, U.S.A.

Consumer information

EMU29811

Important warranty information for U.S.A. and Canada

Welcome to the Yamaha Family!

Congratulations on the purchase of your new Yamaha marine power. Yamaha is committed to exceptional customer satisfaction, and we want your ownership experience to be a satisfying one. Please read the following warranty information to help ensure satisfaction with your Yamaha.

Yamaha is ready to stand behind your purchase with strong warranty coverage. To be sure you receive all the benefits of warranty, please take the following steps:

1. Be sure your new Yamaha is registered for warranty. Your boat dealer should do this at the time of sale. Make sure your dealer gives you a copy of the completed Yamaha registration card for your records. If you are unsure whether or not your Yamaha is registered, complete the Warranty Registration card found inside the cover of the Owner's Manual. Mail it to the distributor for the country in which you live (see step 6 for the correct address). If your Yamaha is not properly registered, a warranty repair could be unnecessarily delayed while registration records are checked.
2. Read the Limited Warranty statement which follows these instructions. This warranty applies to Yamaha outboard motors sold in the United States, whether purchased separately or when supplied as original equipment by a boat builder. The terms also apply to original equipment packages sold in Canada, with coverage provided by Yamaha Motor Canada (see "Warranty Guide" for Canadian models). This warranty explains the conditions of the warranty, including the obligations that your dealer and you as the owner have under the warranty. For example, your Yamaha outboard must receive a proper pre-delivery inspection (PDI) by the selling dealer. Failure to take this important step could jeopardize warranty coverage!
3. If you need warranty repairs, you must take your Yamaha outboard to an authorized Yamaha outboard dealer. Be aware that not all selling boat dealers are authorized Yamaha dealers. Only authorized dealers have the factory training, special tools, and Yamaha support needed to perform warranty repairs.
4. If you are away from home, or your selling dealer is not an authorized Yamaha dealer, use the following toll-free numbers to find the nearest Yamaha dealer.

United States Dealer Locations: 1-800-692-6242

Canada Dealer Locations: 1-800-267-8577

ZMU01682

Consumer information

5. Your warranty applies specifically to repairs made in the country of purchase. If your U.S.-purchased Yamaha needs warranty service while in Canada, or your Canadian purchased Yamaha needs service while in the United States, Yamaha will assist the local dealer whenever possible. However, some products available in one country may not be sold or serviced in the other.
6. If you need any additional information about your Yamaha or warranty coverage which your dealer cannot provide, please contact us directly.

Yamaha Motor Corporation, USA.
1270 Chastain Road
Kennesaw, GA 30144
Attention: Customer Relations Department

Telephone No. (866) 894-1626
Fax No. (770) 420-6106

Yamaha Motor Canada Ltd.
480 Gordon Baker Road
Toronto, Ontario
M2H 3B4
Attention: Customer Relations Department

Telephone No. (416) 498-1911
Fax No. (416) 491-3122

ZMU01683

Consumer information

EMU29830

YAMAHA MOTOR CORPORATION, U.S.A. FOUR-STROKE OUTBOARD MOTOR THREE-YEAR LIMITED WARRANTY

Yamaha Motor Corporation, U.S.A. hereby warrants that new Yamaha 1999-or-later model four-stroke outboard motors originally distributed by Yamaha Motor Corporation, U.S.A. will be free from defects in material and workmanship for the period of time stated herein, subject to certain stated limitations. Warranty coverage for outboards distributed by non-US Yamaha affiliated companies may be different.

PERIOD OF WARRANTY. Any new Yamaha 1999-or-later model four-stroke outboard motor purchased and registered with Yamaha Motor Corporation, U.S.A. for pleasure use in the United States, will be warranted against defects in material or workmanship for a period of three (3) years from the date of purchase, subject to exclusions noted herein. Any Yamaha outboard motor purchased and utilized for commercial applications will be warranted for a period of one (1) year from the date of purchase, subject to exclusions noted herein. Yamaha peripheral equipment included with the motor, such as gauges, fuel tanks, and hoses, remote control boxes, and wiring external from the motor unit, will be warranted for one (1) year from the date of purchase of either pleasure or commercial use. Replacement parts used in warranty repairs will be warranted for the balance of the applicable warranty period.

The second and third year of warranty (if applicable) shall be limited to covering the cost of parts and labor for major components only. The major components covered are:

Power Unit Section

- Power Head
- Intake Manifold
- Carburetor Assembly and its Related Components
- Fuel Injection System and its Related Components
- Fuel and Oil Pump Assemblies
- Ignition System (Standard and Microcomputer)

Lower Unit Section

- Exhaust System
- Upper Casing
- Lower Unit Assembly

Bracket Section

- Bracket System
- Power Trim and Tilt Assembly

WARRANTY REGISTRATION. To be eligible for warranty coverage, the outboard motor must be registered with Yamaha Motor Corporation, U.S.A. Warranty registration can be accomplished by any authorized Yamaha Outboard Motor Dealer. Upon receipt of the registration, an Owner's Warranty Card will be sent by Yamaha to the registered purchaser.

OBTAINING REPAIRS UNDER WARRANTY. To receive repairs under this warranty, a valid Owner's Warranty Card must be presented to an authorized Yamaha Outboard Motor Dealer.

During the period of warranty, any authorized Yamaha outboard dealer will, free of charge, repair or replace, at Yamaha's option, any parts adjudged defective by Yamaha due to faulty workmanship or material from the factory. All replaced parts will become the property of Yamaha Motor Corporation, U.S.A.

CUSTOMER'S RESPONSIBILITY. Under the terms of this warranty, the customer will be responsible for ensuring that the outboard motor is properly operated, maintained, and stored as specified in the applicable Owner's Manual.

The owner of the outboard motor shall give notice to an authorized Yamaha Outboard Motor Dealer of any and all apparent defects within ten (10) days of discovery and make the motor available at that time for inspection and repairs at the dealer's place of business.

GENERAL EXCLUSIONS FROM WARRANTY. This warranty will not cover the repair of damage if the damage is a result of abuse or neglect of the product. Examples of abuse and neglect include, but are not limited to:

1. Racing or competition use, modification of original parts, abnormal strain.
2. Lack of proper maintenance and off season storage as described in the Owner's Manual, installation of parts or accessories that are not equivalent in design and quality genuine Yamaha parts.
3. Operation of the motor at an rpm other than specified, use of lubricants or oils that are not suitable for outboard motor use.
4. Damage as a result of accidents, collisions, contact with foreign materials, or submersion.
5. Growth of marine organism on motor surfaces.
6. Normal deterioration.

ZMU01687

Consumer information

SPECIFIC PARTS EXCLUDED FROM WARRANTY. Parts replaced due to normal wear or routine maintenance such as oil, spark plugs, shear pins, propellers, hubs, fuel and oil filters, brushes for the starter motor and power tilt motor, water pump impellers, and anodes, are not covered by warranty.

Charges for removal of the motor from a boat and transporting the motor to and from an authorized Yamaha Outboard Motor Dealer are excluded from warranty coverage.

Specific parts excluded from the second and third year of warranty (if applicable) are:

- Top and Bottom Cowling
- Electric Components (other than ignition system)
- Rubber Components (such as hoses, tubes, rubber seals, fittings, and clamps)

TRANSFER OF WARRANTY. Transfer of the warranty from the original purchaser to any subsequent purchaser is possible by having the motor inspected by an authorized Yamaha Outboard Motor Dealer and requesting the dealer to submit a change of registration to Yamaha Motor Corporation, U.S.A. within ten (10) days of the transfer.

YAMAHA MOTOR CORPORATION, U.S.A. MAKES NO OTHER WARRANTY OF ANY KIND, EXPRESSED OR IMPLIED. ALL IMPLIED WARRANTIES OF MERCHANTABILITY AND FITNESS FOR A PARTICULAR PURPOSE WHICH EXCEED THE OBLIGATIONS AND TIME LIMITS STATED IN THIS WARRANTY ARE HEREBY DISCLAIMED BY YAMAHA MOTOR CORPORATION, U.S.A. AND EXCLUDED FROM THIS WARRANTY.

SOME STATES DO NOT ALLOW LIMITATIONS ON HOW LONG AN IMPLIED WARRANTY LASTS, SO THE ABOVE LIMITATIONS MAY NOT APPLY TO YOU. ALSO EXCLUDED FROM THIS WARRANTY ARE ANY INCIDENTAL OR CONSEQUENTIAL DAMAGES INCLUDING LOSS OF USE. SOME STATES DO NOT ALLOW THE EXCLUSION OR LIMITATION OF INCIDENTAL OR CONSEQUENTIAL DAMAGES, SO THE ABOVE EXCLUSION MAY NOT APPLY TO YOU.

THIS WARRANTY GIVES YOU SPECIFIC LEGAL RIGHTS, AND YOU MAY ALSO HAVE OTHER RIGHTS WHICH VARY FROM STATE TO STATE.

YAMAHA MOTOR CORPORATION, USA.
1270 Chastain Road
Kennesaw, GA 30144

ZMU01688

Consumer information

EMU29841

IMPORTANT WARRANTY INFORMATION IF YOU USE YOUR YAMAHA OUTSIDE THE USA OR CANADA

Welcome to the Yamaha Family!

Congratulations on the purchase of your new Yamaha Products. Yamaha is committed to exceptional customer satisfaction, and we want your ownership experience to be a satisfying one. Please read the following warranty information to help ensure satisfaction with your Yamaha.

This model was manufactured as a USA specification model, and the warranty statement shown in this manual is for the United States market.

Please note the following information:

1. As explained in the Limited Warranty Statement, the Yamaha warranty covers your Yamaha when it is registered and used in the United States or Canada.
2. If you need repairs while temporarily using your Yamaha in another country, contact the local authorized Yamaha distributor for that country. Yamaha will work with that distributor to make the needed repairs as quickly as possible. If you have to pay for a repair that you believe your warranty would have covered at home, present all repair orders, receipts, or other related documents to your local dealer when you return home. He will be able to contact Yamaha on your behalf to see if any refund can be provided.

NOTE:

Your Yamaha model may not be sold in some countries. Therefore, a Yamaha dealer outside the United States or Canada may not have all of the replacement parts or technical information available to provide proper service. This may unavoidably delay repairs. Thank you for your understanding should this happen.

3. If your Yamaha is registered or used primarily outside the United States or Canada, the warranty printed in this manual does not apply to you. Contact the dealer who sold the Yamaha marine power unit to you for customer support information.

ZMU05199

©2019 Yamaha Motor Corporation, U.S.A.

©2019 Yamaha Motor Corporation, U.S.A.



YAMAHA MOTOR CORPORATION, USA

Printed in Japan

April 2006-0.1 × 1 

Printed on recycled paper