



©2019 Yamaha Motor Corporation, U.S.A.

25

# OWNER'S MANUAL

**U.S.A. Edition**  
LIT-18626-06-93  
6L2-28199-1R

EMU25060

**⚠ WARNING**

The engine exhaust from this product contains chemicals known to the State of California to cause cancer, birth defects or other reproductive harm.

YAMAHA

LIT-CALIF-65-01

ZMU01690

**Read this owner's manual carefully before operating your outboard motor.**

# Important manual information

EMU31280

## To the owner

Thank you for choosing a Yamaha outboard motor. This Owner's Manual contains information needed for proper operation, maintenance and care. A thorough understanding of these simple instructions will help you obtain maximum enjoyment from your new Yamaha. If you have any question about the operation or maintenance of your outboard motor, please consult a Yamaha dealer.

In this Owner's Manual particularly important information is distinguished in the following ways.

 The Safety Alert Symbol means ATTENTION! BECOME ALERT! YOUR SAFETY IS INVOLVED!

EWM00780

### **WARNING**

**Failure to follow WARNING instructions could result in severe injury or death to the machine operator, a bystander, or a person inspecting or repairing the outboard motor.**

ECM00700

### **CAUTION:**

**A CAUTION indicates special precautions that must be taken to avoid damage to the outboard motor.**

### **NOTE:**

A NOTE provides key information to make procedures easier or clearer.

Yamaha continually seeks advancements in product design and quality. Therefore, while this manual contains the most current product information available at the time of printing, there may be minor discrepancies between your machine and this manual. If there is any question concerning this manu-

al, please consult your Yamaha dealer.

### **NOTE:**

The 25MH, 25EH, 25ER and the standard accessories are used as a base for the explanations and illustrations in this manual. Therefore some items may not apply to every model.

EMU25110

25

**OWNER'S MANUAL**

**©2006 by Yamaha Motor Corporation, USA**

**1st edition, March 2006**

**All rights reserved.**

**Any reprinting or unauthorized use without the written permission of Yamaha Motor Corporation, USA is expressly prohibited.**

**Printed in Japan**

**P/N LIT-18626-06-93**

# Table of contents

---

<b>General information</b> .....	1	Starter button .....	16
Identification numbers record .....	1	Main switch .....	16
Outboard motor serial number .....	1	Steering friction adjuster .....	17
Key number.....	1	Trim tab with anode.....	17
Emission control information .....	1	Trim rod (tilt pin) .....	17
North American models.....	1	Shallow water lever .....	18
Safety information .....	2	Tilt lock mechanism.....	18
Important labels .....	3	Tilt support bar .....	18
Warning labels .....	3	Top cowling lock lever(s) (turn type).....	18
Basic boating rules (Rules of the road) .....	4	Warning indicator .....	18
Steering and sailing rules and sound signals .....	4	Warning system .....	19
Rules when encountering vessels ....	5	Overheat warning.....	19
Other special situations.....	6	<b>Operation</b> .....	<b>20</b>
Fueling instructions .....	7	Installation.....	20
Gasoline.....	8	Mounting the outboard motor .....	20
Engine oil .....	8	Clamping the outboard motor.....	21
Battery requirement.....	8	Breaking in engine .....	22
Battery specifications .....	8	Gasoline and engine oil mixing chart (25:1).....	22
Without a rectifier or Rectifier Regulator .....	8	Procedure for pre-mixed models ....	22
Propeller selection.....	9	Preoperation checks .....	23
Start-in-gear protection .....	10	Fuel .....	23
<b>Basic components</b> .....	<b>11</b>	Oil.....	23
Main components.....	11	Controls.....	23
Fuel tank .....	11	Engine .....	23
Fuel joint .....	12	Filling fuel and engine oil .....	23
Fuel gauge .....	12	Filling fuel for portable tank .....	23
Fuel tank cap .....	12	Ring Free Fuel Additive.....	24
Air vent screw .....	12	Gasoline and oil mixing (100:1).....	24
Remote control.....	12	Operating engine .....	25
Remote control lever.....	12	Feeding fuel (portable tank) .....	25
Neutral interlock trigger .....	13	Starting engine .....	26
Neutral throttle lever.....	13	Warming up engine .....	33
Choke switch.....	13	Choke start models .....	33
Tiller handle .....	13	Shifting .....	33
Gear shift lever.....	14	Forward (tiller handle and remote control models) .....	33
Throttle grip.....	14	Reverse (manual tilt and hydro tilt models) .....	34
Throttle indicator .....	14	Stopping engine .....	35
Throttle friction adjuster.....	14	Procedure.....	35
Engine stop lanyard switch .....	15	Trimming outboard motor.....	36
Engine stop button .....	15	Adjusting trim angle for manual tilt models .....	36
Choke knob for pull type .....	16		
Manual starter handle .....	16		

# Table of contents

Adjusting boat trim .....	37	Checking battery (for electric start models) .....	56
Tilting up and down .....	38	Connecting the battery .....	57
Procedure for tilting up (manual tilt models) .....	38	Disconnecting the battery .....	58
Procedure for tilting down (manual tilt models) .....	39	Checking top cowling .....	58
Cruising in shallow water .....	39	Coating the boat bottom .....	58
Cruising in shallow water (manual tilt models) .....	39	<b>Trouble Recovery.....</b>	<b>59</b>
Cruising in other conditions .....	41	Troubleshooting .....	59
<b>Maintenance.....</b>	<b>42</b>	Temporary action in emergency ...	62
Specifications .....	42	Impact damage .....	62
Transporting and storing outboard motor .....	43	Replacing fuse .....	62
Clamp screw mounting models .....	44	Starter will not operate .....	63
Storing outboard motor .....	44	Emergency starting engine .....	63
Procedure .....	44	Treatment of submerged motor ...	65
Lubrication (except oil injection models) .....	45	Procedure.....	65
Cleaning and anticorrosion measures .....	45	<b>Consumer information .....</b>	<b>66</b>
Battery care.....	46	Important warranty information for U.S.A. and Canada .....	66
Cleaning the outboard motor .....	46	YAMAHA MOTOR CORPORATION, U.S.A. OUTBOARD MOTOR TWO YEAR LIMITED WARRANTY .....	68
Checking painted surface of motor.....	46	IMPORTANT WARRANTY INFORMATION IF YOU USE YOUR YAMAHA OUTSIDE THE USA OR CANADA .....	71
Periodic maintenance.....	47		
Replacement parts .....	47		
Maintenance chart .....	48		
Greasing .....	49		
Cleaning and adjusting spark plug .....	50		
Checking fuel system .....	50		
Inspecting fuel filter .....	51		
Cleaning fuel filter .....	51		
Inspecting idling speed .....	52		
Checking wiring and connectors .....	52		
Exhaust leakage .....	52		
Water leakage .....	52		
Checking propeller .....	53		
Removing the propeller .....	54		
Installing the Propeller .....	54		
Changing gear oil .....	54		
Cleaning fuel tank .....	55		
Inspecting and replacing anode(s).....	56		

# General information

EMU25170

## Identification numbers record

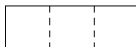

EMU25183

### Outboard motor serial number

The outboard motor serial number is stamped on the label attached to the port side of the clamp bracket.

Record your outboard motor serial number in the spaces provided to assist you in ordering spare parts from your Yamaha dealer or for reference in case your outboard motor is stolen.

ZMU01693

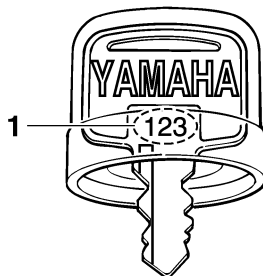

ZMU01694

1. Key number

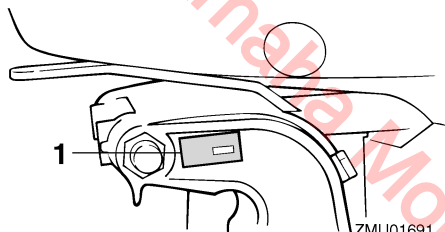

ZMU01691

1. Outboard motor serial number location

EMU25221

## Emission control information

EMU25230

### North American models

This engine conforms to U.S. Environmental Protection Agency (EPA) regulations for marine SI engines. See the label affixed to your engine for details.

EMU30390

### Approval label of emission control certificate

This label is attached to the bottom cowling. Existing Technology; N/A

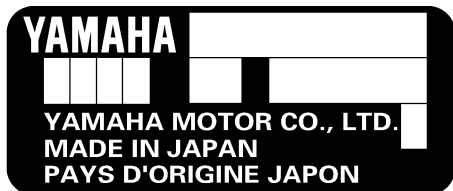

ZMU01692

EMU25190

### Key number

If a main key switch is equipped with the motor, the key identification number is stamped on your key as shown in the illustration. Record this number in the space provided for reference in case you need a new key.

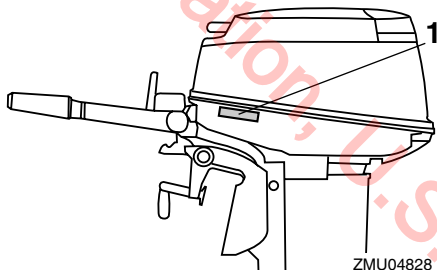

ZMU04828

1. Approval label location

# General information

EMISSION CONTROL INFORMATION			
ENGINE FAMILY : [.....]			
THIS ENGINE CONFORMS TO [.....] U.S. EPA REGULATIONS FOR MARINE SI ENGINES. REFER TO THE OWNERS MANUAL FOR MAINTENANCE SPECIFICATIONS AND ADJUSTMENTS.			
FEL : [.....] g/kWh	IDLE SPEED : [.....] rpm IN NEUTRAL		
SPARK PLUG : [.....]	SPARK PLUG GAP (mm) : [.....]		
DISPLACEMENT : [.....] cm <sup>3</sup>	FUEL : GASOLINE		
ADVERTISED POWER : [.....] kW	VALVE LASH (mm) : IN : N/A EX : N/A		
YAMAHA MOTOR CO.,LTD. [.....]			

ZMU05230

EMU25262

## Manufactured date label

This label is attached to the clamp bracket or the swivel bracket.

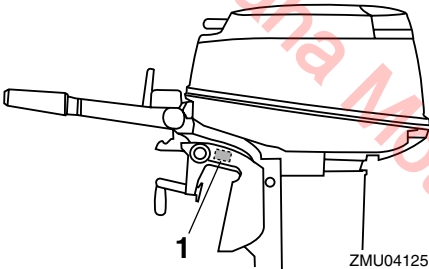

1. Manufactured date label location

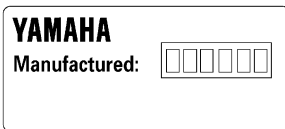

ZMU01701

EMU25362

## Safety information

- Before mounting or operating the outboard motor, read this entire manual. Reading it

should give you an understanding of the motor and its operation.

- Before operating the boat, read any owner's or operator's manuals supplied with it and all labels. Be sure you understand each item before operating.
- Do not overpower the boat with this outboard motor. Overpowering the boat could result in loss of control. The rated power of the outboard should be equal to or less than the rated horsepower capacity of the boat. If the rated horsepower capacity of the boat is unknown, consult the dealer or boat manufacturer.
- Do not modify the outboard. Modifications could make the motor unfit or unsafe to use.
- Incorrect propeller selection and incorrect use may not only cause engine damage, but also adversely affect fuel consumption. Consult your dealer for correct use.
- Never operate after drinking alcohol or taking drugs. About 50% of all boating fatalities involve intoxication.
- Have an approved personal flotation device (PFD) on board for every occupant. It is a good idea to wear a PFD whenever boating. At a minimum, children and non-swimmers should always wear PFDs, and everyone should wear PFDs when there are potentially hazardous boating conditions.
- Gasoline is highly flammable, and its vapors are flammable and explosive. Handle and store gasoline carefully. Make sure there are no gas fumes or leaking fuel before starting the engine.
- This product emits exhaust gases which contain carbon monoxide, a colorless, odorless gas which may cause brain damage or death when inhaled. Symptoms in-

# General information

clude nausea, dizziness, and drowsiness. Keep cockpit and cabin areas well ventilated. Avoid blocking exhaust outlets.

- Check throttle, shift, and steering for proper operation before starting the engine.
- Attach the engine stop switch lanyard cord to a secure place on your clothing, or your arm or leg while operating. If you accidentally leave the helm, the cord will pull from the switch, stopping the engine.
- Know the marine laws and regulations where you will be boating—and obey them. For basic boating rules, see “Rules of the road” on page 4.
- Stay informed about the weather. Check weather forecasts before boating. Avoid boating in hazardous weather.
- Tell someone where you are going: leave a Float Plan with a responsible person. Be sure to cancel the Float Plan when you return.
- Use common sense and good judgment when boating. Know your abilities, and be sure you understand how your boat handles under the different boating conditions you may encounter. Operate within your limits, and the limits of your boat. Always operate at safe speeds, and keep a careful watch for obstacles and other traffic.
- Always watch carefully for swimmers during the engine operation.
- Stay away from swimming areas.
- When a swimmer is in the water near you shift into neutral and shut off the engine.
- Do not illegally discard empty containers used to replace or replenish oil. For the correct processing of empty containers, consult the dealer where you purchased the oil.
- When replacing oils used to lubricate the product (engine or gear oil), be sure to

wipe away any spilt oil. Never pour oil without using a funnel or similar device. If necessary, verify the necessary replacement procedure with the dealer.

- Never illegally discard (dump) the product. Yamaha recommends consulting the dealer on discarding the product.

Be informed about boating safety. Additional publications and information can be obtained from many organizations, including the following:

## **United States Coast Guard**

Consumer Affairs Staff (G-BC)

Office of Boating, Public, and Consumer Affairs

U.S. Coast Guard Headquarters

Washington, D.C. 20593-0001

Boating Safety Hotline: 1-800-368-5647

## **National Marine Manufacturers Association (NMMA)**

401 N. Michigan Ave.

Chicago, IL 60611

## **Marine Retailers Association of America**

155 N. Michigan Ave.

Chicago, IL 60601

EMU25382

## Important labels

EMU25395

## Warning labels

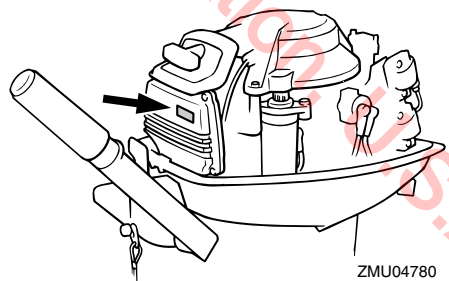

ZMU04780



# General information

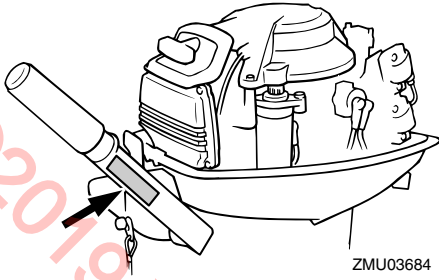

EMU25401

## Label

EWM01260



- Be sure shift control is in neutral before starting engine. (except 2HP)
- Do not touch or remove electrical parts when starting or during operation.
- Keep hands, hair, and clothes away from flywheel and other rotating parts while engine is running.

EMU25431

## Label

EWM01300



- This engine is equipped with a neutral starting device.
- The engine will not start unless the shift control is in neutral position.

EMU25500

## Basic boating rules (Rules of the road)

Just as there are rules which apply when you are driving on streets and highways, there are waterway rules which apply when you are driving your boat. These rules are used internationally, and are also enforced by the United States Coast Guard and local agencies. You should be aware of these rules, and follow them whenever you encounter another vessel on the water.

Several sets of rules prevail according to geographic location, but are all basically the same as the International Rules of the Road. The rules presented here in your Owner's Manual are condensed, and have been provided for your convenience only. Consult your local U.S. Coast Guard Auxiliary or Department of Motor Vehicles for a complete set of rules governing the waters in which you will be using your boat.

EMU25510

## Steering and sailing rules and sound signals

Whenever two vessels on the water meet one another, one vessel has the right-of-way; it is called the "stand-on" vessel. The vessel which does not have the right-of-way is called the "give-way" or "burdened" vessel. These rules determine which vessel has the right-of-way, and what each vessel should do.

### Stand-on vessel

The vessel with the right-of-way has the duty to continue its course and speed, except to avoid an immediate collision. When you maintain your direction and speed, the other vessel will be able to determine how best to avoid you.

### Give-way vessel

The vessel which does not have the right-of-way has the duty to take positive and timely action to stay out of the way of the Stand-On vessel. Normally, you should not cross in front of the vessel with the right-of-way. You should slow down or change directions briefly and pass behind the other vessel. You should always move in such a way that the operator of the other vessel can see what you are doing.

### "The general prudential rule"

This rule is called Rule 2 in the International Rules and says,

# General information

“In obeying and construing these rules due regard shall be had to all dangers of navigation and collision, and to any special circumstances, which may render a departure from the above rules necessary in order to avoid immediate danger.”

In other words, follow the standard rules except when a collision will occur unless both vessels try to avoid each other. If that is the case, both vessels become “Give-Way” vessels.

EMU25520

## Rules when encountering vessels

There are three main situations which you may encounter with other vessels which could lead to a collision unless the Steering Rules are followed:

**Meeting:** (you are approaching another vessel head-on)

**Crossing:** (you are traveling across the other vessel's path)

**Overtaking:** (you are passing or being passed by another vessel)

In the following illustration, your boat is in the center. You should give the right-of-way to any vessels shown in white area (you are the Give-Way vessel). Any vessels in the shaded area must yield to you (they are the Give-Way vessels). Both you and the meeting vessel must alter course to avoid each other.

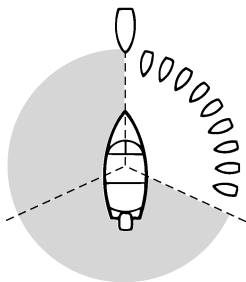

## Meeting

If you are meeting another power vessel head on, and are close enough to run the risk of collision, neither of you has the right-of-way! Both of you should alter course to avoid an accident. You should keep the other vessel on your port (left) side. This rule doesn't apply if both of you will clear one another if you continue on your set course and speed.

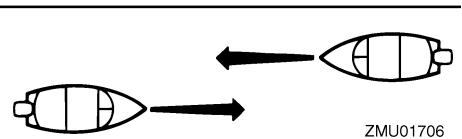
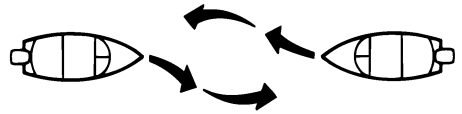

## Crossing

When two power driven vessels are crossing each other's path close enough to run the risk of collision, the vessel which has the other on the starboard (right) side must keep out of the way of the other. If the other vessel is on your right, you must keep out of its way; you are the Give-Way vessel. If the other vessel is on your port (left) side, remember that you should maintain course and direction, provided the other vessel gives you the right-of-way as it should.

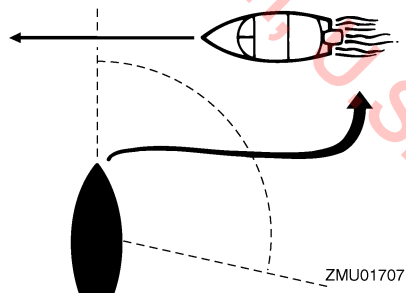

## Overtaking

If you are passing another vessel, you are the “Give-Way” vessel. This means that the other vessel is expected to maintain its course and speed. You must stay out of its way until you are clear of it. Likewise, if another vessel is passing you, you should maintain your speed and direction so that the other vessel can steer itself around you.

EMU25530

## Other special situations

There are three other rules you should be aware of when driving your boat around other vessels.

### Narrow channels and bends

When navigating in narrow channels, you should keep to the right when it is safe and practical to do so. If the operator of a power-driven vessel is preparing to go around a bend that may obstruct the view of other water vessels, the operator should sound a prolonged blast on the whistle (4 to 6 seconds). If another vessel is around the bend, it too should sound the whistle. Even if no reply is heard, however, the vessel should still proceed around the bend with caution. If you navigate such waters with your boat, you will need to carry a portable air horn, available from local marine supply stores.

### Fishing vessel right-of-way

All vessels which are fishing with nets, lines or trawls are considered to be “fishing vessels” under the International Rules. Vessels with trolling lines are not considered fishing vessels. Fishing vessels have the right-of-way regardless of position. Fishing vessels cannot, however, impede the passage of other vessels in narrow channels.

### Sailing vessel right-of-way

Sailing vessels should normally be given the right-of-way. The exceptions to this are:

1. When the sailing vessel is overtaking

the power-driven vessel, the power-driven vessel has the right-of-way.

2. Sailing vessels should keep clear of any fishing vessel.
3. In a narrow channel, a sailing vessel should not hamper the safe passage of a power-driven vessel which can navigate only in such a channel.

## Reading buoys and other markers

The waters of the United States are marked for safe navigation by the lateral system of buoyage. Simply put, buoys and markers have an arrangement of shapes, colors, numbers and lights to show which side of the buoy a boater should pass on when navigating in a particular direction. The markings on these buoys are oriented from the perspective of being entered from seaward (the boater is going towards the port). This means that red buoys are passed on the starboard (right) side when proceeding from open water into port, and black buoys are to port (left) side. When navigating out of port, your position with respect to the buoys should be reversed; red buoys should be to port and black buoys to starboard.

Many bodies of water used by boaters are entirely within the boundaries of a particular state. The Uniform State Waterway Marking System has been devised for these waters. This system uses buoys and signs with distinctive shapes and colors to show regulatory or advisory information. These markers are white with black letters and orange borders. They signify speed zones, restricted areas, danger areas, and general information.

Remember, markings may vary by geographic location. Always consult local boating authorities before driving your boat in unfamiliar waters.

# General information

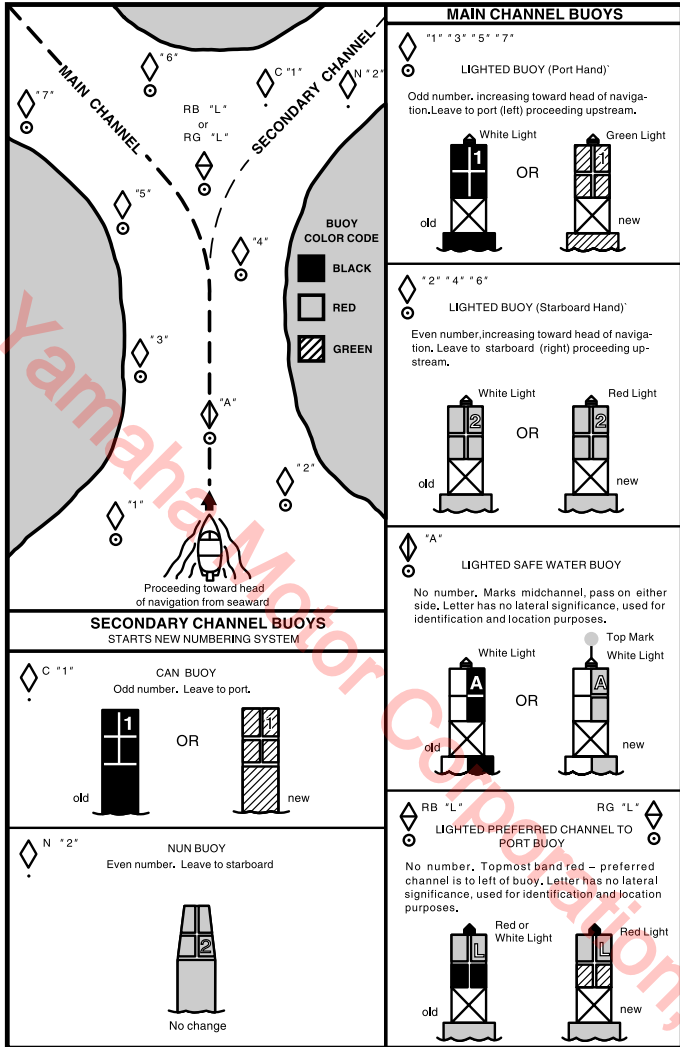

ZMU01708

EMU25540

## Fueling instructions

EWM00010



**WARNING**

**GASOLINE AND ITS VAPORS ARE HIGHLY FLAMMABLE AND EXPLOSIVE!**

- Do not smoke when refueling, and keep

away from sparks, flames, or other sources of ignition.

- Stop engine before refueling.
- Refuel in a well-ventilated area. Refuel portable fuel tanks off the boat.
- Take care not to spill gasoline. If gasoline spills, wipe it up immediately with

# General information

dry rags.

- Do not overfill the fuel tank.
- Tighten the filler cap securely after refueling.
- If you should swallow some gasoline, inhale a lot of gasoline vapor, or get gasoline in your eyes, get immediate medical attention.
- If any gasoline spills onto your skin, immediately wash with soap and water. Change clothing if gasoline spills on it.
- Touch the fuel nozzle to the filler opening or funnel to help prevent electrostatic sparks.

ECM00010

## CAUTION:

Use only new clean gasoline which has been stored in clean containers and is not contaminated with water or foreign matter.

EMU25570

## Gasoline

If knocking or pinging occurs, use a different brand of gasoline or premium unleaded fuel.

Recommended gasoline:

Regular unleaded gasoline with a minimum octane rating of 86 (Pump Octane Number) =  $(R+M)/2$

## Gasohol

There are two types of gasohol: gasohol containing ethanol and that containing methanol. Gasohol containing ethanol can be used if ethanol content does not exceed 10% and the fuel meets minimum octane ratings. Yamaha does not recommend gasohol containing methanol because it can cause fuel system damage or engine performance problems.

EMU25650

## Engine oil

Recommended engine oil:

YAMALUBE 2-stroke outboard motor oil

If the recommended engine oil is not available, another 2-stroke engine oil with an NMMA-certified TC-W3 rating may be used.

EMU25690

## Battery requirement

ECM01060

### CAUTION:

Do not use a battery that does not meet the specified capacity. If a battery which does not meet specifications is used, the electric system could perform poorly or be overloaded, causing electric system damage.

For electric start models, choose a battery which meets the following specifications.

EMU25711

## Battery specifications

Minimum cold cranking amps (CCA/SAE):

25EH 245.0 A

25ER 245.0 A

Minimum marine cranking amps (MCA/ABYC):

25EH 323.0 A

25ER 323.0 A

Minimum reserve capacity (RC/SAE):

25EH 52 minutes

25ER 52 minutes

EMU25730

## Without a rectifier or Rectifier Regulator

ECM01090

### CAUTION:

A battery cannot be connected to models

# General information

## that do not have a rectifier or Rectifier Regulator.

If you wish to use a battery with the models without a rectifier or Rectifier Regulator, install an optional Rectifier Regulator.

Using a maintenance-free battery with the above models can shorten the life of the battery significantly.

Install an optional Rectifier Regulator or use accessories rated to withstand 18 volts or higher with the above models. Consult your Yamaha dealer for details on installing an optional Rectifier Regulator.

EMU25742

## Propeller selection

The performance of your outboard motor will be critically affected by your choice of propeller, as an incorrect choice could adversely affect performance and could also seriously damage the motor. Engine speed depends on the propeller size and boat load. If engine speed is too high or too low for good engine performance, this will have an adverse effect on the engine.

Yamaha outboard motors are fitted with propellers chosen to perform well over a range of applications, but there may be uses where a propeller with a different pitch would be more appropriate. For a greater operating load, a smaller-pitch propeller is more suitable as it enables the correct engine speed to be maintained. Conversely, a larger-pitch propeller is more suitable for a smaller operating load.

Yamaha dealers stock a range of propellers, and can advise you and install a propeller on your outboard that is best suited to your application.

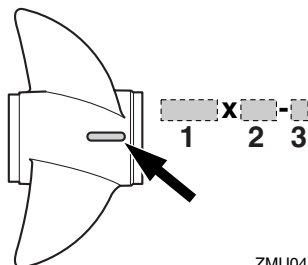

ZMU04605

1. Propeller diameter in inches
2. Propeller pitch in inches
3. Type of propeller (propeller mark)

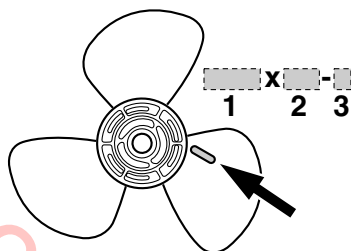

ZMU04604

1. Propeller diameter in inches
2. Propeller pitch in inches
3. Type of propeller (propeller mark)

## NOTE:

Select a propeller which will allow the engine to reach the middle or upper half of the operating range at full throttle with the maximum boat load. If operating conditions such as light boat loads then allow the engine r/min to rise above the maximum recommended range, reduce the throttle setting to maintain the engine in the proper operating range.

For instructions on propeller removal and installation, see page 53.

EMU25770

## **Start-in-gear protection**

Yamaha outboard motors or Yamaha-approved remote control units are equipped with start-in-gear protection device(s). This feature permits the engine to be started only when it is in neutral. Always select neutral before starting the engine.

©2019 Yamaha Motor Corporation, U.S.A.

# Basic components

EMU25797

## Main components

### NOTE:

\* May not be exactly as shown; also may not be included as standard equipment on all models.

25

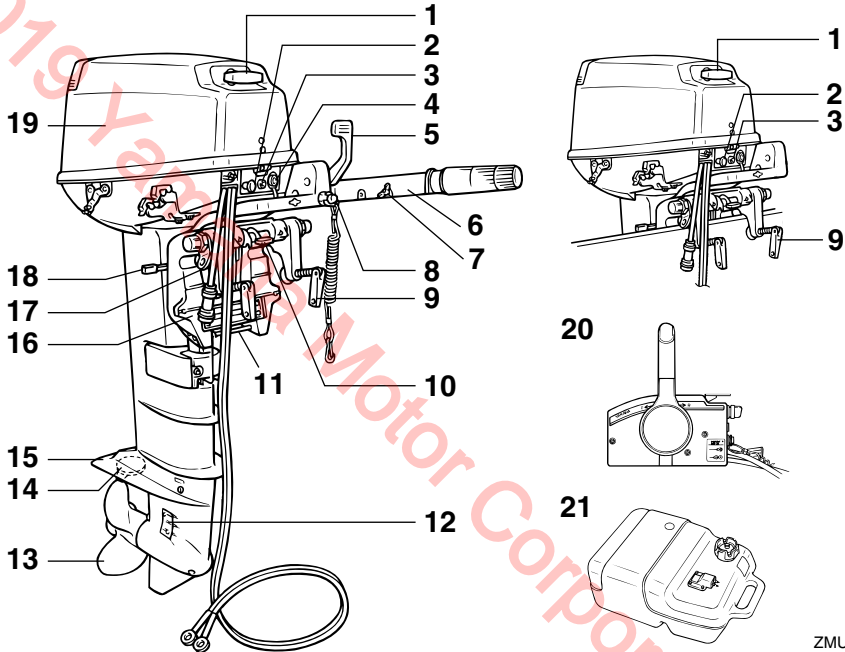

1. Manual starter handle\*
2. Choke knob
3. Warning indicator
4. Starter button\*
5. Gear shift lever\*
6. Tiller handle\*
7. Throttle friction adjuster\*
8. Engine stop button/Engine stop lanyard switch\*
9. Transom clamp handle
10. Tilt lock lever
11. Trim rod
12. Cooling water inlet
13. Propeller
14. Trim tab (anode)

15. Anti-cavitation plate
16. Clamp bracket
17. Rope attachment
18. Shallow water lever
19. Top cowling
20. Remote control box (side mount type)\*
21. Fuel tank\*

EMU25802

### Fuel tank

If your model was equipped with a portable

ZMU04829



# Basic components

fuel tank, its function is as follows.

EWM00020

## WARNING

The fuel tank supplied with this engine is its dedicated fuel reservoir and must not be used as a fuel storage container. Commercial users should conform to relevant licensing or approval authority regulations.

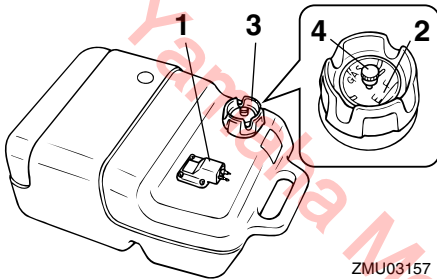

1. Fuel joint
2. Fuel gauge
3. Fuel tank cap
4. Air vent screw

EMU25830

## Fuel joint

This joint is used to connect the fuel line.

EMU25841

## Fuel gauge

This gauge is located on either the fuel tank cap or on the fuel joint base. It shows the approximate amount of fuel remaining in the tank.

EMU25850

## Fuel tank cap

This cap seals the fuel tank. When removed, the tank can be filled with fuel. To remove the cap, turn it counterclockwise.

EMU25860

## Air vent screw

This screw is on the fuel tank cap. To loosen the screw, turn it counterclockwise.

EMU26180

## Remote control

The remote control lever actuates both the shifter and the throttle. The electrical switches are mounted on the remote control box.

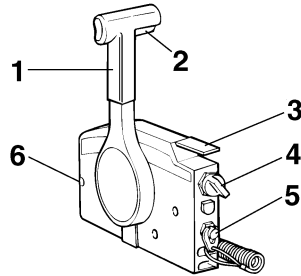

1. Remote control lever
2. Neutral interlock trigger
3. Neutral throttle lever
4. Main switch / choke switch
5. Engine stop lanyard switch
6. Throttle friction adjuster

EMU26190

## Remote control lever

Moving the lever forward from the neutral position engages forward gear. Pulling the lever back from neutral engages reverse. The engine will continue to run at idle until the lever is moved about 35° (a detent can be felt). Moving the lever farther opens the throttle, and the engine will begin to accelerate.

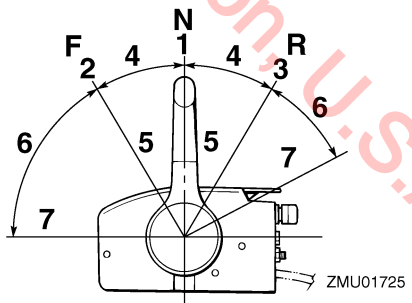

1. Neutral "N"

# Basic components

2. Forward "F"
3. Reverse "R"
4. Shift
5. Fully closed
6. Throttle
7. Fully open

EMU26201

## Neutral interlock trigger

To shift out of neutral, first pull the neutral interlock trigger up.

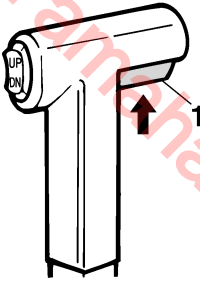

ZMU01727

1. Neutral interlock trigger

EMU26211

## Neutral throttle lever

To open the throttle without shifting into either forward or reverse, put the remote control lever in the neutral position and lift the neutral throttle lever.

### NOTE:

The neutral throttle lever will operate only when the remote control lever is in neutral. The remote control lever will operate only when the neutral throttle lever is in the closed position.

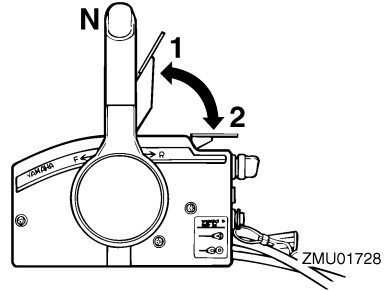

ZMU01728

1. Fully open
2. Fully closed

EMU26221

## Choke switch

To activate the choke system, press in the main switch while the key is turned to the "ON" (on) or "START" (start) position. The choke system will then supply the rich fuel mixture required to start the engine. When the key is released, the choke will switch off automatically.

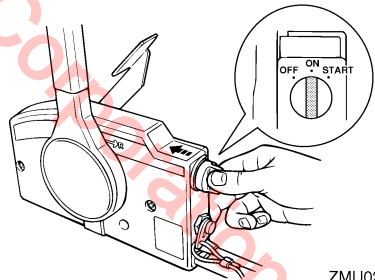

ZMU02206

EMU25911

## Tiller handle

To change direction, move the tiller handle to the left or right as necessary.

# Basic components

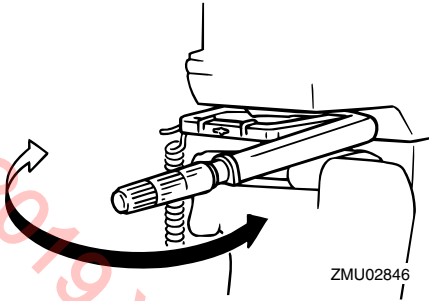

EMU25922

## Gear shift lever

Pulling the gear shift lever towards you puts the engine in forward gear so that the boat moves ahead. Pushing the lever away from you puts the engine in reverse gear so that the boat moves astern.

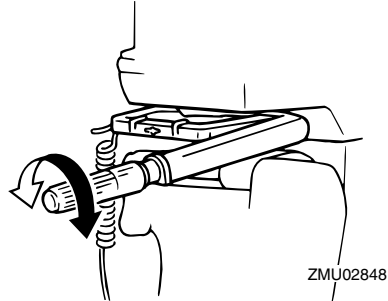

EMU25961

## Throttle indicator

The fuel consumption curve on the throttle indicator shows the relative amount of fuel consumed for each throttle position. Choose the setting that offers the best performance and fuel economy for the desired operation.

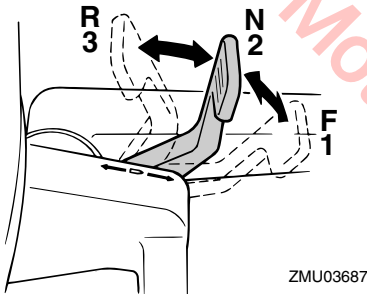

1. Forward "F"
2. Neutral "N"
3. Reverse "R"

EMU25941

## Throttle grip

The throttle grip is on the tiller handle. Turn the grip counterclockwise to increase speed and clockwise to decrease speed.

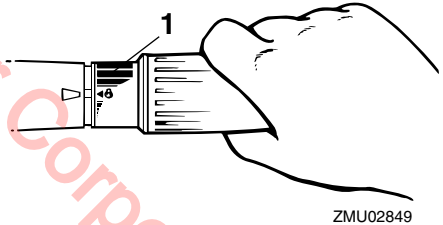

1. Throttle indicator

EMU25971

## Throttle friction adjuster

A friction device provides adjustable resistance to movement of the throttle grip or the remote control lever, and can be set according to operator preference.

To increase resistance, turn the adjuster clockwise. To decrease resistance, turn the adjuster counterclockwise.

EWM00031



**Do not overtighten the friction adjuster. If**

# Basic components

there is too much resistance, it could be difficult to move the remote control lever or throttle grip, which could result in an accident.

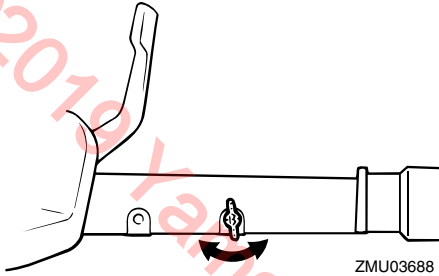

When constant speed is desired, tighten the adjuster to maintain the desired throttle setting.

EMU25990

## Engine stop lanyard switch

The lock plate must be attached to the engine stop switch for the engine to run. The lanyard should be attached to a secure place on the operator's clothing, or arm or leg. Should the operator fall overboard or leave the helm, the lanyard will pull out the lock plate, stopping ignition to the engine. This will prevent the boat from running away under power.

EWM00120

### WARNING

- Attach the engine stop switch lanyard to a secure place on your clothing, or your arm or leg while operating.
- Do not attach the lanyard to clothing that could tear loose. Do not route the lanyard where it could become entangled, preventing it from functioning.
- Avoid accidentally pulling the lanyard during normal operation. Loss of engine power means the loss of most steering control. Also, without engine

power, the boat could slow rapidly. This could cause people and objects in the boat to be thrown forward.

### NOTE:

The engine cannot be started with the lock plate removed.

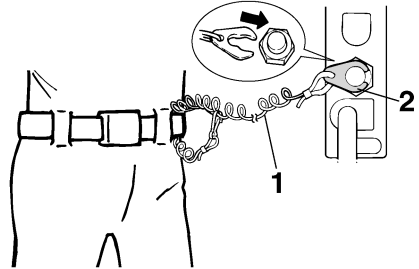

ZMU01716

1. Lanyard
2. Lock plate

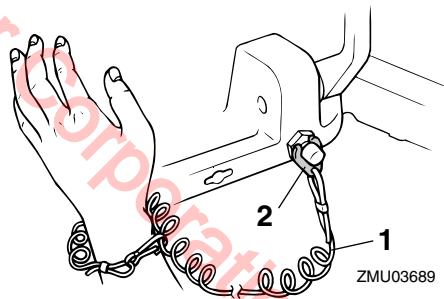

ZMU03689

1. Lanyard
2. Lock plate

EMU26001

## Engine stop button

To open the ignition circuit and stop the engine, push this button.

# Basic components

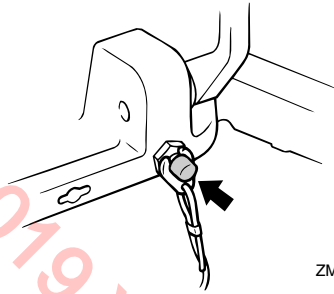

ZMU03690

EMU26011

## Choke knob for pull type

To supply the engine with the rich fuel mixture required to start, pull out this knob.

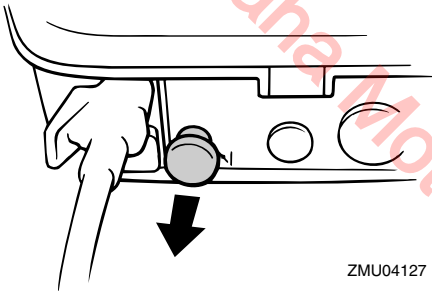

ZMU04127

EMU26070

## Manual starter handle

To start the engine, first gently pull the handle out until resistance is felt. From that position, then pull the handle straight out quickly to crank the engine.

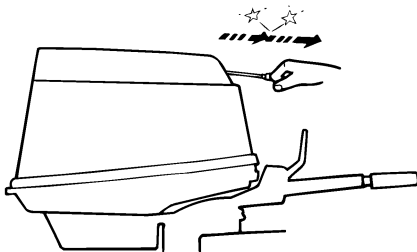

ZMU02735

EMU26080

## Starter button

To start the engine with the electric starter, push the starter button.

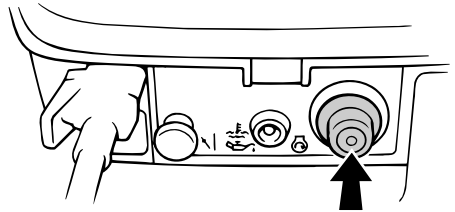

ZMU04856

EMU26090

## Main switch

The main switch controls the ignition system; its operation is described below.

- "OFF" (off)

With the main switch in the "OFF" (off) position, the electrical circuits are off, and the key can be removed.

- "ON" (on)

With the main switch in the "ON" (on) position, the electrical circuits are on, and the key cannot be removed.

- "START" (start)

With the main switch in the "START" (start) position, the starter motor turns to start the engine. When the key is released, it returns automatically to the "ON" (on) position.

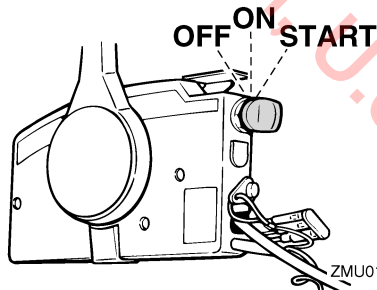

ZMU01718

# Basic components

EMU26122

## Steering friction adjuster

A friction device provides adjustable resistance to the steering mechanism, and can be set according to operator preference. An adjusting screw or bolt is located on the swivel bracket.

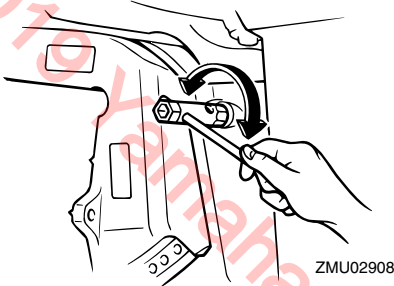

To increase resistance, turn the adjuster clockwise.

To decrease resistance, turn the adjuster counterclockwise.

EWM00040

### **WARNING**

**Do not overtighten the friction adjuster. If there is too much resistance, it could be difficult to steer, which could result in an accident.**

EMU26241

## Trim tab with anode

The trim tab should be adjusted so that the steering control can be turned to either the right or left by applying the same amount of force.

EWM00040

### **WARNING**

**An improperly adjusted trim tab could cause difficult steering. Always test run after the trim tab has been installed or replaced to be sure steering is correct. Be sure you have tightened the bolt after adjusting the trim tab.**

If the boat tends to veer the left (port side), turn the trim tab rear end to the port side "A" in the figure. If the boat tends to veer the right (starboard side), turn the trim tab end to the starboard side "B" in the figure.

ECM00840

### **CAUTION:**

**The trim tab also serves as an anode to protect the engine from electrochemical corrosion. Never paint the trim tab as it will become ineffective as an anode.**

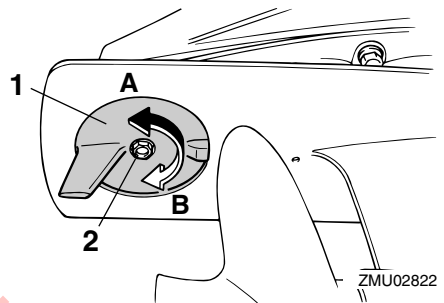

1. Trim tab
2. Bolt

EMU26261

## Trim rod (tilt pin)

The position of the trim rod determines the minimum trim angle of the outboard motor in relation to the transom.

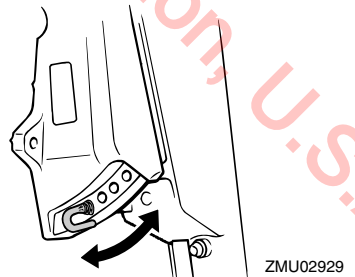

# Basic components

EMU26270

## Shallow water lever

Lifting this lever will tilt the motor up partially to provide more clearance when operating in shallow water.

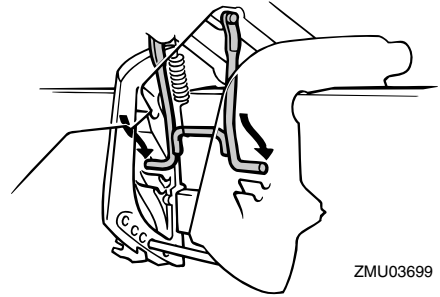
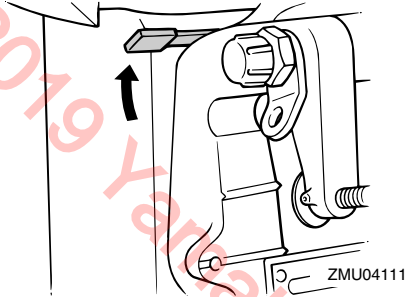

EMU26372

## Top cowling lock lever(s) (turn type)

To remove the engine top cowling, turn the lock lever(s) and lift off the cowling. When installing the cowling, check to be sure it fits properly in the rubber seal. Then lock the cowling again by returning the lever(s) to the lock position.

EMU30530

## Tilt lock mechanism

The tilt lock mechanism is used to prevent the outboard motor from lifting out of the water when in reverse gear.

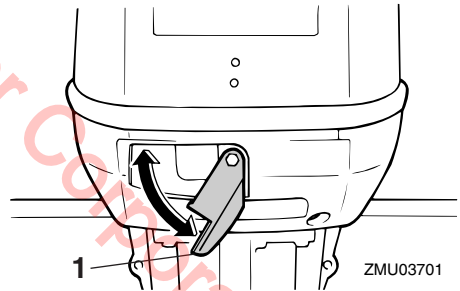
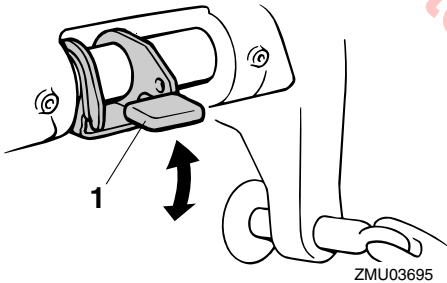

1. Top cowling lock lever(s)

1. Tilt lock lever

To lock it, set the tilt lock lever in the lock position. To release, push the tilt lock lever in the release position.

EMU26330

## Tilt support bar

The tilt support bar keeps the outboard motor in the tilted up position.

EMU26301

## Warning indicator

If the engine develops a condition which is cause for warning, the indicator lights up. For details on how to read the warning indicator, see page 19.

# Basic components

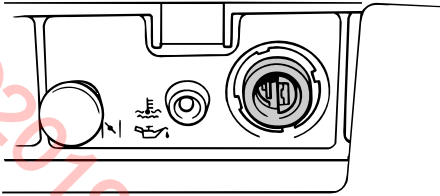

ZMU03703

EMU26801

## Warning system

ECM00090

### CAUTION:

**Do not continue to operate the engine if a warning device has activated. Consult your Yamaha dealer if the problem cannot be located and corrected.**

EMU26816

## Overheat warning

This engine has an overheat warning device. If the engine temperature rises too high, the warning device will activate.

### Activation of warning device

- The engine speed will automatically decrease to about 2000 r/min.
- If equipped with an overheat warning indicator, it will light or blink.

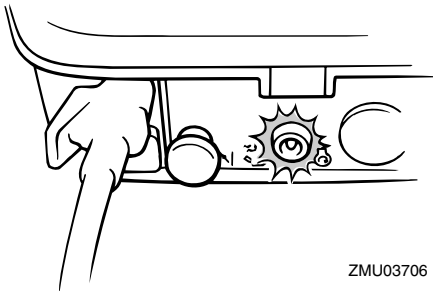

ZMU03706

- The buzzer will sound (if equipped on the tiller handle, remote control box, or main switch panel).

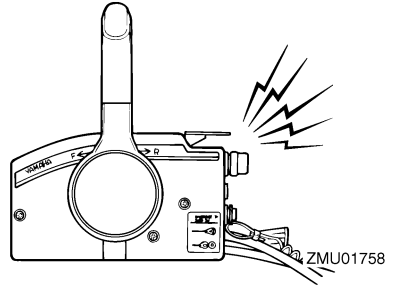

ZMU01758

If the warning system has activated, stop the engine and check the cooling water inlet for clogging.

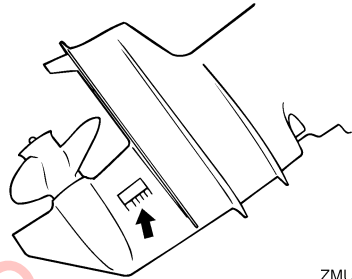

ZMU02392



EMU26901

## Installation

ECM00110

### CAUTION:

Incorrect engine height or obstructions to smooth water flow (such as the design or condition of the boat, or accessories such as transom ladders or depth finder transducers) can create airborne water spray while the boat is cruising. Severe engine damage may result if the motor is operated continuously in the presence of airborne water spray.

### NOTE:

During water testing check the buoyancy of the boat, at rest, with its maximum load. Check that the static water level on the exhaust housing is low enough to prevent water entry into the powerhead, when water rises due to waves when the outboard is not running.

EMU26910

## Mounting the outboard motor

EWM00820

### WARNING

- Overpowering a boat could cause severe instability. Do not install an outboard motor with more horsepower than the maximum rating on the capacity plate of the boat. If the boat does not have a capacity plate, consult the boat manufacturer.
- The information presented in this section is intended as reference only. It is not possible to provide complete instructions for every possible boat and motor combination. Proper mounting depends in part on experience and the

specific boat and motor combination.

EWM00830

### WARNING

Improper mounting of the outboard motor could result in hazardous conditions such as poor handling, loss of control, or fire hazards. Observe the following:

- For permanently mounted models, your dealer or other person experienced in proper rigging should mount the motor. If you are mounting the motor yourself, you should be trained by an experienced person.
- For portable models, your dealer or other person experienced in proper outboard motor mounting should show you how to mount your motor.

Mount the outboard motor on the center line (keel line) of the boat, and ensure that the boat itself is well balanced. Otherwise the boat will be hard to steer. For boats without a keel or which are asymmetrical, consult your dealer.

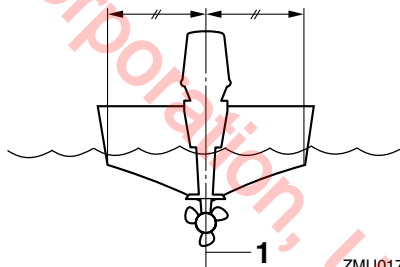

1. Center line (keel line)

EMU26920

## Mounting height

To run your boat at optimum efficiency, the water resistance (drag) of the boat and outboard motor must be made as little as possible. The mounting height of the outboard

# Operation

motor greatly affects the water resistance. If the mounting height is too high, cavitation tends to occur, thus reducing the propulsion; and if the propeller tips cut the air, the engine speed will rise abnormally and cause the engine to overheat. If the mounting height is too low, the water resistance will increase and thereby reduce engine efficiency. Mount the outboard motor so that the anti-cavitation plate is between the bottom of the boat and a level 25 mm (1 in.) below it.

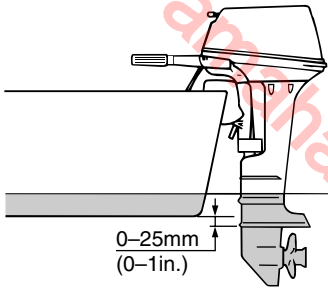

come loose due to engine vibration.

EWM00640

## **WARNING**

**Loose clamp screws could allow the outboard motor to fall off or move on the transom. This could cause loss of control and serious injury. Make sure the transom screws are tightened securely. Occasionally check the screws for tightness during operation.**

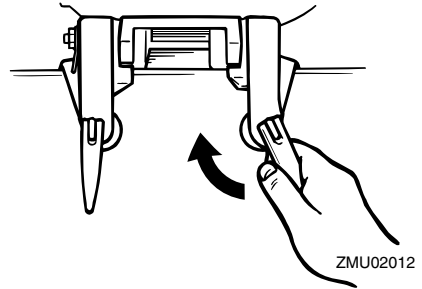

### **NOTE:**

- The optimum mounting height of the outboard motor is affected by the boat and motor combination and the desired use. Test runs at different heights can help determine the optimum mounting height. Consult your Yamaha dealer or boat manufacturer for further information on determining the proper mounting height.
- For instructions on setting the trim angle of the outboard motor, see page 36.

EMU26970

### **Clamping the outboard motor**

1. Place the outboard motor on the transom so that it is positioned as close to the center as possible. Tighten the transom clamp screws evenly and securely. Occasionally check the clamp screws for tightness during operation of the outboard motor because they could be-

2. If the engine restraint cable attachment is equipped on your engine, an engine restraint cable or chain should be used. Attach one end to the engine restraint cable attachment and the other to a secure mounting point on the boat. Otherwise the engine could be completely lost if it accidentally falls off the transom.

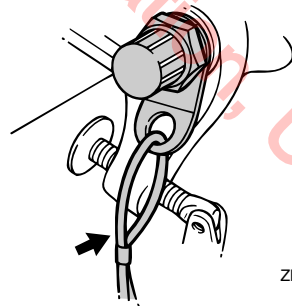

3. Secure the clamp bracket to the transom using the bolts provided with the out-

board (if packed). For details, consult your Yamaha dealer.

EWM00650

## **WARNING**

**Avoid using bolts, nuts or washers other than those contained in the engine packaging. If used, they must be of at least the same quality of material and strength and must be tightened securely. After tightening, test run the engine and check their tightness.**

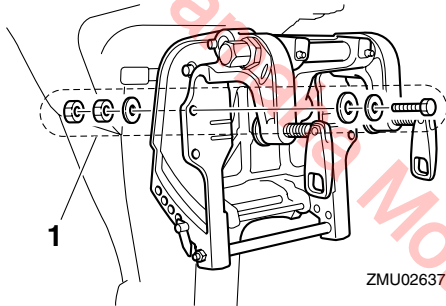

ZMU02637

1. Bolts

ECM00173

## **Breaking in engine**

Your new engine requires a period of break-in to allow mating surfaces of moving parts to wear in evenly. Correct break-in will help ensure proper performance and longer engine life.

ECM00800

## **CAUTION:**

**Failure to follow the break-in procedure could result in reduced engine life or even severe engine damage.**

EMU27050

## **Gasoline and engine oil mixing chart (25:1)**

	25:1			
	1 L (0.26 US gal, 0.22 Imp gal)	12 L (3.2 US gal, 2.6 Imp gal)	14 L (3.7 US gal, 3.1 Imp gal)	24 L (6.3 US gal, 5.3 Imp gal)
	0.04 L (0.04 US qt, 0.04 Imp qt)	0.48 L (0.51 US qt, 0.42 Imp qt)	0.56 L (0.59 US qt, 0.49 Imp qt)	0.96 L (1.01 US qt, 0.84 Imp qt)

ZMU02393

- : Gasoline
- : Engine oil

ECM00150

## **CAUTION:**

**Be sure to mix gasoline and oil completely, otherwise the engine may be damaged.**

EMU27074

## **Procedure for pre-mixed models**

Run the engine under load (in gear with a propeller installed) for 10 hours as follows.

- First 10 minutes:
  - Run the engine at the lowest possible speed. A fast idle in neutral is best.
- Next 50 minutes:
  - Do not exceed half throttle (approximately 3000 r/min). Vary engine speed occasionally. If you have an easy-planing boat, accelerate at full throttle onto plane, then immediately reduce the throttle to 3000 r/min or less.
- Next two hours:
  - Accelerate at full throttle onto plane, then reduce engine speed to three-quarter throttle (approximately 4000 r/min). Vary engine speed occasionally. Run at full throttle for one minute, then allow about 10 minutes of operation at three-quarter throttle or less to let the engine

# Operation

---

cool.

4. Remaining seven hours:  
Run the engine at any speed. However, avoid operating at full throttle for more than 5 minutes at a time.
5. After the first 10 hours:  
Operate the engine normally. Use the standard premix ratio of gasoline and oil. For details on mixing fuel and oil, see page 23.

EMU27102

## Preoperation checks

EWM00080

### **WARNING**

If any item in the preoperation check is not working properly, have it inspected and repaired before operating the outboard motor. Otherwise an accident could occur.

ECM00120

### **CAUTION:**

Do not start the engine out of water. Overheating and serious engine damage can occur.

EMU27111

## Fuel

- Check to be sure you have plenty of fuel for your trip.
- Make sure there are no fuel leaks or gasoline fumes.
- Check fuel line connections to be sure they are tight (if equipped Yamaha fuel tank or boat tank).
- Be sure the fuel tank is positioned on a secure, flat surface, and that the fuel line is not twisted or flattened, or likely to contact sharp objects (if equipped Yamaha fuel tank or boat tank).

EMU27120

## Oil

- Check to be sure you have plenty of oil for

your trip.

EMU27130

## Controls

- Check throttle, shift, and steering for proper operation before starting the engine.
- The controls should work smoothly, without binding or unusual free play.
- Look for loose or damaged connections.
- Check operation of the starter and stop switches when the outboard motor is in the water.

EMU27140

## Engine

- Check the engine and engine mounting.
- Look for loose or damaged fasteners.
- Check the propeller for damage.

EMU27233

## Filling fuel and engine oil

EMU27242

### Filling fuel for portable tank

EWM00060

### **WARNING**

Gasoline and its vapors are highly flammable and explosive. Keep away from sparks, cigarettes, flames, or other sources of ignition.

1. Remove the fuel tank cap.
2. Fill the fuel tank carefully.
3. Close the cap securely after refueling. Wipe up any spilled fuel.

Fuel tank capacity (if equipped Yamaha fuel tank): 25 L (6.60 US gal) (5.50 Imp.gal)
---

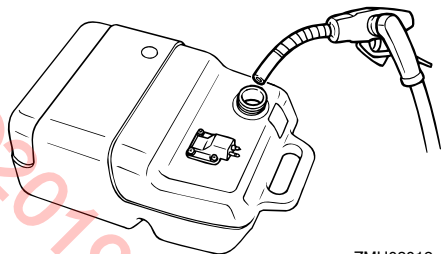

ZMU03012

EMU27270

## Ring Free Fuel Additive

Gasoline is a precise blend of many different substances, each chosen to give certain characteristics. Gasoline blends have been changing in recent years in response to concerns about pollution and resulting emissions regulations. One of the most obvious changes has been the elimination of lead from most fuels.

As gasoline has changed, the amount of additives such as aromatics and oxygenates has increased. These additives are important for the engines in passenger cars, but they can have detrimental effects in marine engines, because of increased deposits in the combustion chamber. When enough deposits collect, piston rings begin sticking. Performance drops and engine wear increases dramatically.

While many additives available may reduce deposits, Yamaha recommends the use of **Ring Free Fuel Additive**, available from your Yamaha dealer. **Ring Free Fuel Additive** has repeatedly proven its ability to clean combustion deposits from inside the engine, notably the critical piston-ring-land area, and fuel system components. Follow product labeling for use instructions.

EMU27404

## Gasoline and oil mixing (100:1)

	Gasoline to engine oil ratio
Break-in period	See page 22
After break-in	100:1

If equipped with a portable fuel tank

1. Pour oil into the portable fuel tank, and then add gasoline.

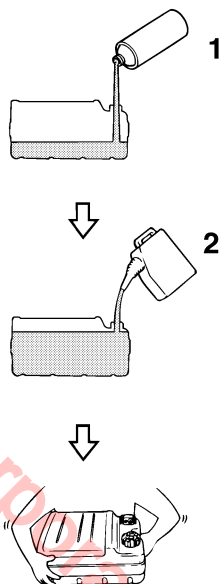

ZMU02394

1. Engine oil
2. Gasoline
2. Replace the fuel tank cap and close tightly.
3. Shake the fuel tank to mix the fuel thoroughly.
4. Make sure that the oil and gasoline are mixed.

If equipped with a built-in fuel tank

1. Pour oil into a clean fuel can, and then add gasoline.

# Operation

2. Replace the fuel can cap and close tightly.
3. Shake the fuel can to mix the fuel thoroughly.
4. Make sure that the oil and gasoline are mixed.
5. Pour the gasoline and oil mixture into the built-in fuel tank.

ECM00810

## CAUTION:

- Avoid using any oil other than the specified type.
- Use a thoroughly blended fuel-oil mixture.
- If the mixture is not thoroughly mixed, or if the mixing ratio is incorrect, the following problems could occur. **Low oil ratio:** Lack of oil could cause major engine trouble, such as piston seizure.
- **High oil ratio:** Too much oil could cause fouled spark plugs, smoky exhaust, and heavy carbon deposits.

## NOTE:

If using a permanently installed tank, pour the oil gradually as the gasoline is being added to the tank.

EMU27450

## Operating engine

EMU27461

### Feeding fuel (portable tank)

EWMO0420

## WARNING

- Before starting the engine, make sure that the boat is tightly moored and that you can steer clear of any obstructions. Be sure there are no swimmers in the water near you.
- When the air vent screw is loosened, gasoline vapor will be released. Gasoline is highly flammable, and its vapors

are flammable and explosive. Refrain from smoking, and keep away from open flames and sparks while loosening the air vent screw.

- This product emits exhaust gases which contain carbon monoxide, a colorless, odorless gas which could cause brain damage or death when inhaled. Symptoms include nausea, dizziness, and drowsiness. Keep cockpit and cabin areas well ventilated. Avoid blocking exhaust outlets.

1. If there is an air vent screw on the fuel tank cap, loosen it 2 or 3 turns.

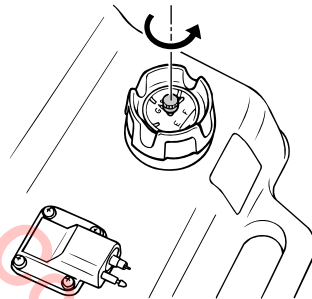

ZMU02022

2. If there is a fuel joint on the motor, firmly connect the fuel line to the joint. Then firmly connect the other end of the fuel line to the joint on the fuel tank.

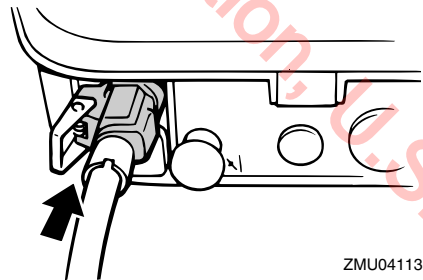

ZMU04113

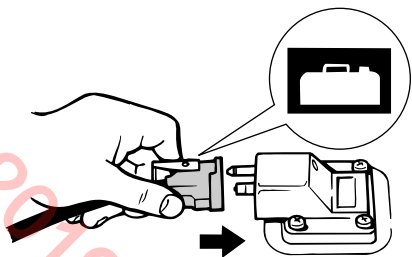

ZMU02024

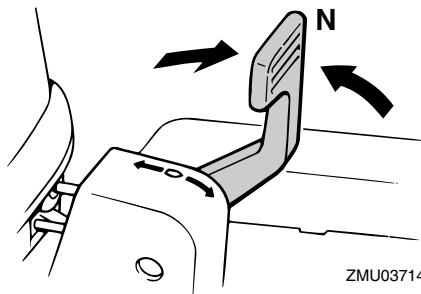

ZMU03714

3. If a steering friction adjuster is provided on your outboard motor, securely attach the fuel line to the fuel line clamp.

**NOTE:**

During engine operation place the tank horizontally, otherwise fuel cannot be drawn from the fuel tank.

4. Squeeze the primer pump with the outlet end up until you feel it become firm.



ZMU02025

EMU27490

## Starting engine

EMU27505

### Manual start models (tiller control)

1. Place the gear shift lever in neutral.

**NOTE:**

The start-in-gear protection device prevents the engine from starting except when in neutral.

2. Attach the engine stop switch lanyard to a secure place on your clothing, or your arm or leg. Then install the lock plate on the other end of the lanyard into the engine stop switch.

EWM00120

**WARNING**

- Attach the engine stop switch lanyard to a secure place on your clothing, or your arm or leg while operating.
- Do not attach the lanyard to clothing that could tear loose. Do not route the lanyard where it could become entangled, preventing it from functioning.
- Avoid accidentally pulling the lanyard during normal operation. Loss of engine power means the loss of most steering control. Also, without engine power, the boat could slow rapidly. This could cause people and objects in the boat to be thrown forward.

# Operation

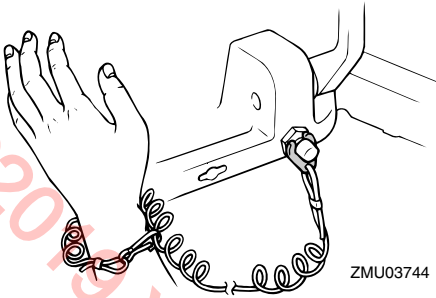

3. Place the throttle grip in the "START" (start) position.

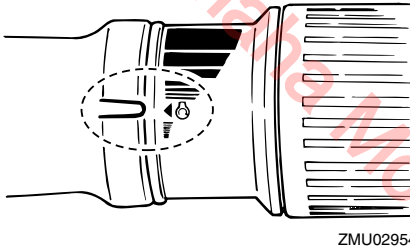

4. Pull out / turn the choke knob fully. After the engine starts, replace / return the knob to the home position.

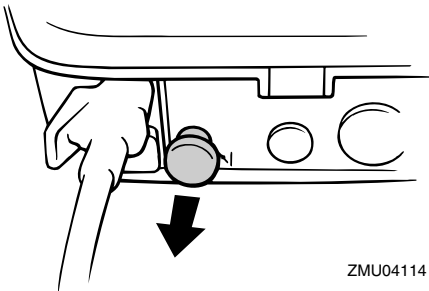

## NOTE:

- It is not necessary to use the choke when starting a warm engine.
- If the choke knob is left in the "START" (start) position while the engine is running,

the engine will run poorly or stall.

5. Pull the manual starter handle slowly until you feel resistance. Then give a strong pull straight out to crank and start the engine. Repeat if necessary.

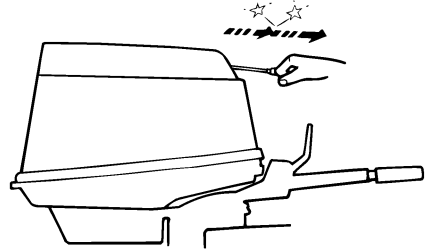

6. After the engine starts, slowly return the manual starter handle to its original position before releasing it.
7. Slowly return the throttle grip to the fully closed position.

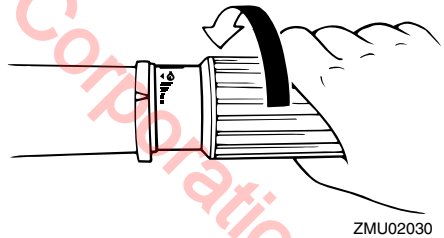

## NOTE:

- When the engine is cold, it needs to be warmed up. For further information, see page 33.
- If the engine does not start on the first try, repeat the procedure. If the engine fails to start after 4 or 5 tries, open the throttle a small amount (between 1/8 and 1/4) and try again. Also if the engine is warm and fails to start, open the throttle a same



amount and try to start the engine again. If the engine still fails to start, see page 59.

EMU27562

## Electric start models

1. Place the gear shift lever in neutral.

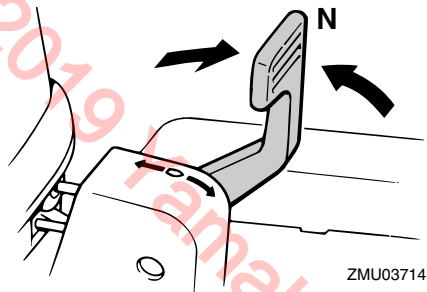

### NOTE:

The start-in-gear protection device prevents the engine from starting except when in neutral.

2. Attach the engine stop switch lanyard to a secure place on your clothing, or your arm or leg. Then install the lock plate on the other end of the lanyard into the engine stop switch.

EWM00120

### **WARNING**

- Attach the engine stop switch lanyard to a secure place on your clothing, or your arm or leg while operating.
- Do not attach the lanyard to clothing that could tear loose. Do not route the lanyard where it could become entangled, preventing it from functioning.
- Avoid accidentally pulling the lanyard during normal operation. Loss of engine power means the loss of most steering control. Also, without engine power, the boat could slow rapidly. This could cause people and objects in the boat to be thrown forward.

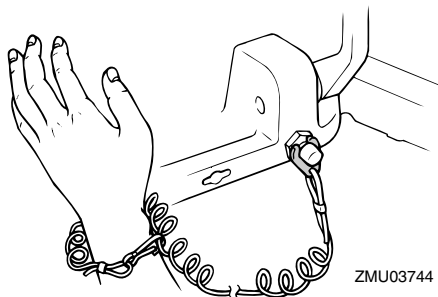

3. Place the throttle grip in the "START" (start) position. After the engine starts, return the throttle to the fully closed position.

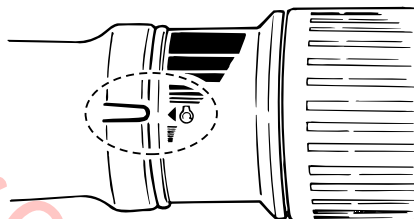

4. Pull out / turn the choke knob fully. After the engine starts, replace / return the knob to the home position.

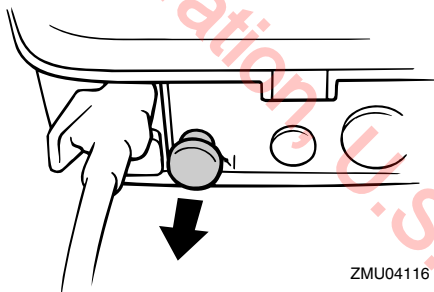

### NOTE:

- It is not necessary to use the choke when starting a warm engine.

# Operation

- If the choke knob is left in the “START” (start) position while the engine is running, the engine will run poorly or stall.

5. Push the starter button to start the motor. (Repeat if necessary.)

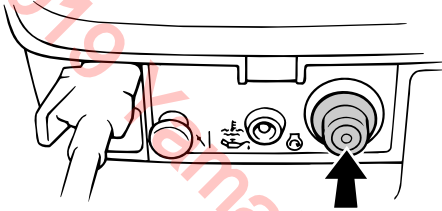

6. Immediately after the engine starts, release the starter button to allow it to return to its original position.
7. Slowly return the throttle grip to the fully closed position so that the engine does not stall.

ECM00160

## CAUTION:

- Never push the starter button while the engine is running.
- Do not keep the starter motor turning for more than 5 seconds. If the starter motor is turned continuously for more than 5 seconds, the battery will be quickly discharged, thus making it impossible to start the engine. The starter can also be damaged. If the engine will not start after 5 seconds of cranking, release the starter button, wait 10 seconds, then crank the engine again.

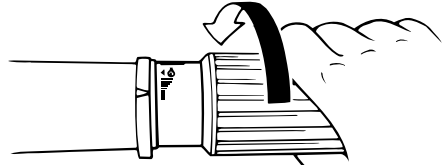

ZMU02962

## NOTE:

- When the engine is cold, it needs to be warmed up. For further information, see page 33.
- If the engine does not start on the first try, repeat the procedure. If the engine fails to start after 4 or 5 tries, open the throttle a small amount (between 1/8 and 1/4) and try again. Also if the engine is warm and fails to start, open the throttle a same amount and try to start the engine again. If the engine still fails to start, see page 59.

EMU27633

## Manual start models (remote control)

1. Place the remote control lever in neutral.

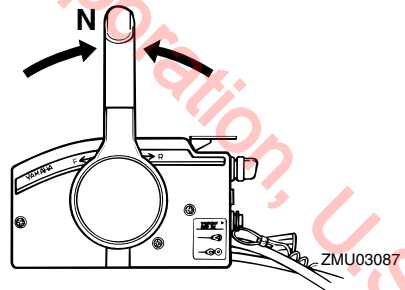

ZMU03087

## NOTE:

The start-in-gear protection device prevents the engine from starting except when in neutral.

2. Attach the engine stop switch lanyard to

a secure place on your clothing, or your arm or leg. Then install the lock plate on the other end of the lanyard into the engine stop switch.

EWM00120

## WARNING

- Attach the engine stop switch lanyard to a secure place on your clothing, or your arm or leg while operating.
- Do not attach the lanyard to clothing that could tear loose. Do not route the lanyard where it could become entangled, preventing it from functioning.
- Avoid accidentally pulling the lanyard during normal operation. Loss of engine power means the loss of most steering control. Also, without engine power, the boat could slow rapidly. This could cause people and objects in the boat to be thrown forward.

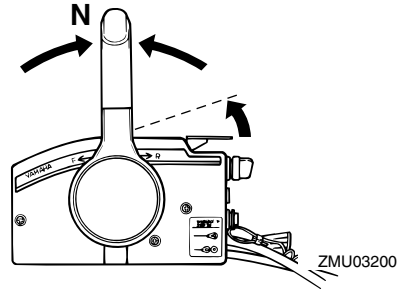

## NOTE:

- As a starting point, lift the lever just until you feel resistance, then lift slightly more.
  - The neutral throttle lever can only be used when the remote control lever is in neutral.
4. Pull out / turn the choke knob fully. After the engine starts, replace / return the knob to the home position.

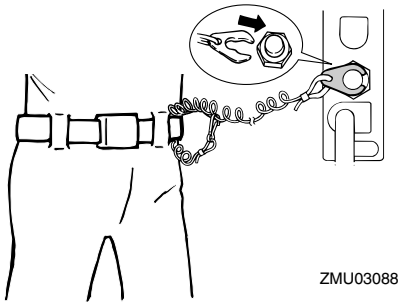

3. Open the throttle slightly without shifting using the neutral throttle lever. You may need to change the throttle opening slightly depending on engine temperature. After the engine starts, return the throttle to the original position.

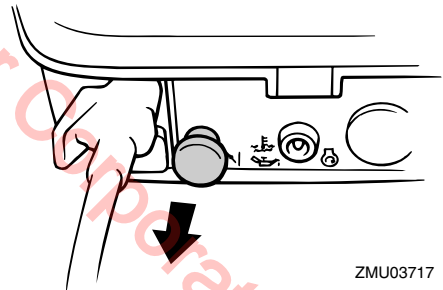

## NOTE:

- It is not necessary to use the choke when starting a warm engine.
  - If the choke knob is left in the "START" (start) position while the engine is running, the engine will run poorly or stall.
5. Pull the manual starter handle slowly until you feel resistance. Then give a strong pull straight out to crank and start the engine. Repeat if necessary.

# Operation

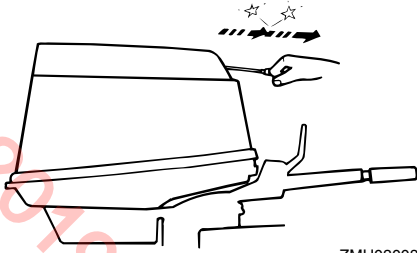

ZMU03008

6. After the engine starts, slowly return the manual starter handle to its original position before releasing it.

## NOTE:

- When the engine is cold, it needs to be warmed up. For further information, see page 33.
- If the engine does not start on the first try, repeat the procedure. If the engine fails to start after 4 or 5 tries, open the throttle a small amount and try again. Also if the engine is warm and fails to start, open the throttle a small amount and try to start the engine again. If the engine still fails to start, see page 59.

EMU27642

## Electric start / remote control models

1. Place the remote control lever in neutral.

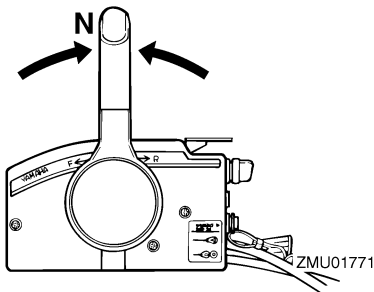

## NOTE:

The start-in-gear protection device prevents

the engine from starting except when in neutral.

2. Attach the engine stop switch lanyard to a secure place on your clothing, or your arm or leg. Then install the lock plate on the other end of the lanyard into the engine stop switch.

EWM00120

## WARNING

- Attach the engine stop switch lanyard to a secure place on your clothing, or your arm or leg while operating.
- Do not attach the lanyard to clothing that could tear loose. Do not route the lanyard where it could become entangled, preventing it from functioning.
- Avoid accidentally pulling the lanyard during normal operation. Loss of engine power means the loss of most steering control. Also, without engine power, the boat could slow rapidly. This could cause people and objects in the boat to be thrown forward.

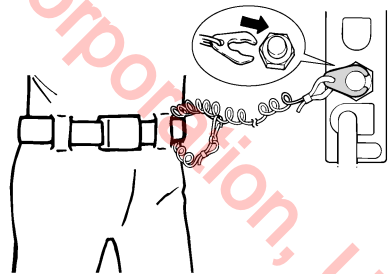

ZMU01772

3. Turn the main switch to "ON" (on).

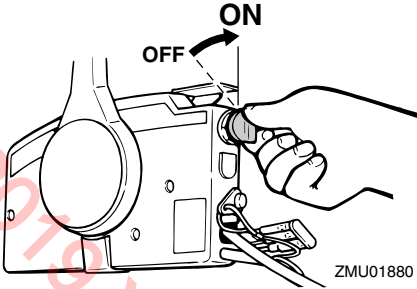

4. Open the throttle slightly without shifting using the neutral throttle lever or free accelerator. You may need to change the throttle opening slightly depending on engine temperature. After the engine starts, return the throttle to the original position.

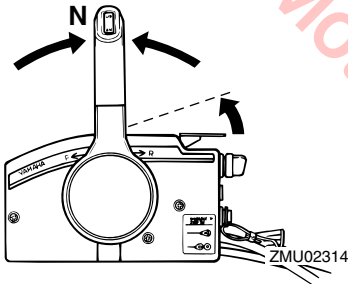

**NOTE:**

- On remote controls equipped with a neutral throttle lever, a good starting point is to lift the lever just until you feel resistance, then lift slightly more.
- The neutral throttle lever or free accelerator can only be used when the remote control lever is in neutral.

5. Press in and hold the main switch to operate the remote choke system. The remote choke switch automatically returns to its normal position when you release your hand. Therefore keep the switch

pressed in.

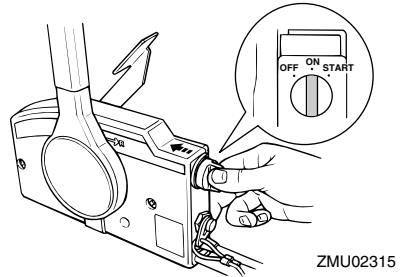

**NOTE:**

- It is not necessary to use the choke when starting a warm engine.
  - Push in the main switch fully, or the remote choke system will not operate.
6. Turn the main switch to "START" (start), and hold it for a maximum of 5 seconds.

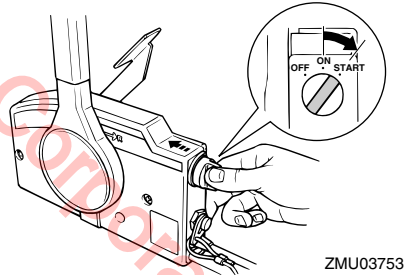

7. Immediately after the engine starts, release the main switch and allow it to return to "ON" (on).

ECM00191

**CAUTION:**

- **Never turn the main switch to "START" (start) while the engine is running.**
- **Do not keep the starter motor turning for more than 5 seconds. If the starter motor is turned continuously for more than 5 seconds, the battery will be quickly discharged, thus making it im-**

# Operation

possible to start the engine. The starter can also be damaged. If the engine will not start after 5 seconds of cranking, return the main switch to "ON" (on), wait 10 seconds, then crank the engine again.

EMU27670

## Warming up engine

EMU27681

### Choke start models

1. After starting the engine, allow it to idle for 3 minutes to warm up. Failure to do so will shorten engine life. Gradually return the choke knob to its home position as the engine warms up.
2. Check for a steady flow of water from the cooling water pilot hole.

ECM00511

### CAUTION:

A continuous flow of water from the cooling water pilot hole shows that the water pump is pumping water through the cooling passages. If water is not flowing out of the hole at all times while the engine is running, overheating and serious damage could occur. Stop the engine and check whether the cooling water inlet on the lower case or the cooling water pilot hole is blocked. Consult your Yamaha dealer if the problem cannot be located and corrected.

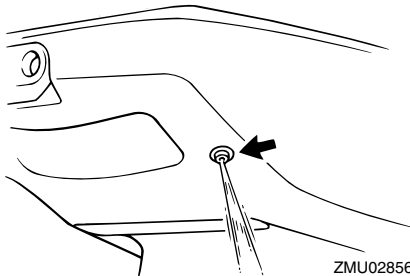

ZMU02856

EMU27740

## Shifting

EWM00180

### WARNING

Before shifting, make sure there are no swimmers or obstacles in the water near you.

ECM00220

### CAUTION:

To change the boat direction or shifting position from forward to reverse or vice-versa, first close the throttle so that the engine idles (or runs at low speeds).

EMU27764

### Forward (tiller handle and remote control models)

#### Tiller handle models

1. Place the throttle grip in the fully closed position.

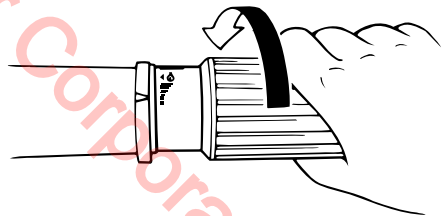

ZMU02030

2. Move the gear shift lever quickly and firmly from neutral to forward.

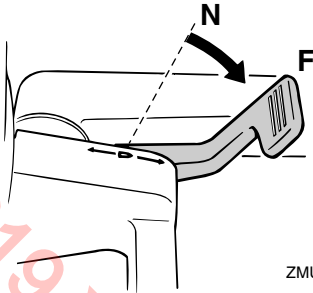

ZMU03718

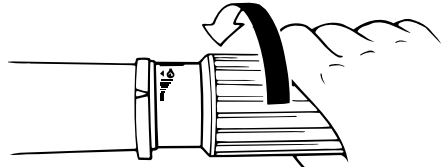

ZMU02030

## Remote control models

1. Pull up the neutral interlock trigger (if equipped) and move the remote control lever quickly and firmly from neutral to forward.

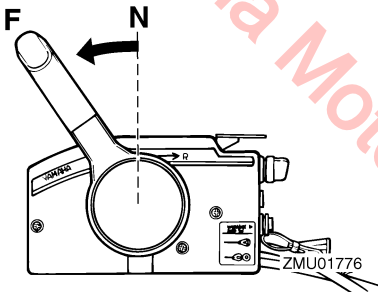

ZMU01776

EMU27796

## Reverse (manual tilt and hydro tilt models)

EWM00190

### **WARNING**

When operating in reverse, go slowly. Do not open the throttle more than half. Otherwise the boat could become unstable, which could result in loss of control and an accident.

## Tiller handle models

1. Place the throttle grip in the fully closed position.

2. On models equipped with a tilt lock lever, check that it is in the lock/down position.

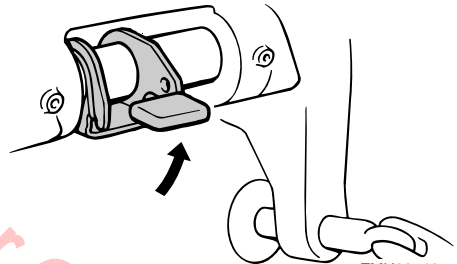

ZMU03719

3. Move the gear shift lever quickly and firmly from neutral to reverse.

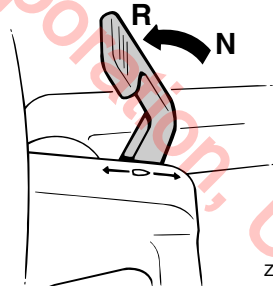

ZMU03720

## Remote control models

1. Check that the tilt lock lever is in the lock position.

# Operation

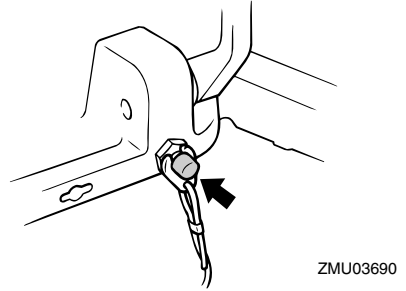
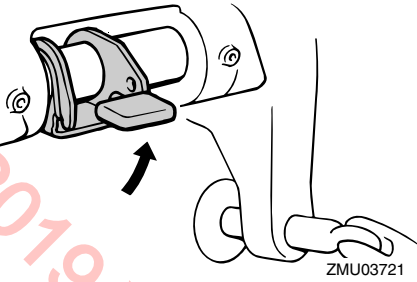

2. Pull up the neutral interlock trigger (if equipped) and move the remote control lever quickly and firmly from neutral to reverse.

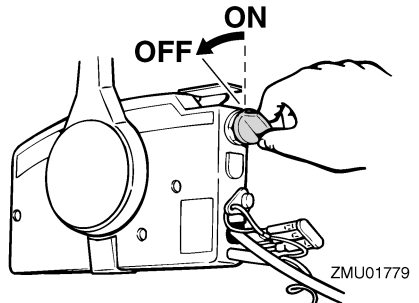
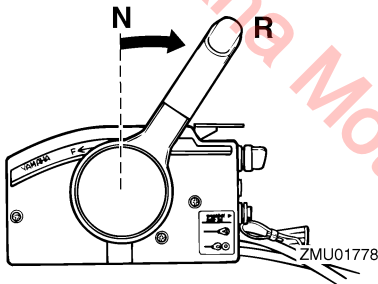

2. After stopping the engine, disconnect the fuel line if there is a fuel joint on the outboard motor.

EMU27820

## Stopping engine

Before stopping the engine, first let it cool off for a few minutes at idle or low speed. Stopping the engine immediately after operating at high speed is not recommended.

EMU27844

### Procedure

1. Push and hold the engine stop button or turn the main switch to "OFF" (off).

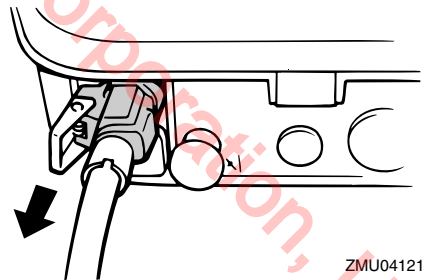

3. Tighten the air vent screw on the fuel tank cap (if equipped).



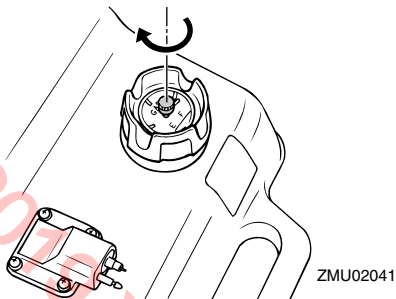

4. Remove the key if the boat will be left unattended.

**NOTE:**

The engine can also be stopped by pulling the lanyard and removing the lock plate from the engine stop switch, then turning the main switch to "OFF" (off).

EMU27861

## Trimming outboard motor

The trim angle of the outboard motor helps determine the position of the bow of the boat in the water. Correct trim angle will help improve performance and fuel economy while reducing strain on the engine. Correct trim angle depends upon the combination of boat, engine, and propeller. Correct trim is also affected by variables such as the load in the boat, sea conditions, and running speed.

EWM00740

**WARNING**

Excessive trim for the operating conditions (either trim up or trim down) can cause boat instability and can make steering the boat more difficult. This increases the possibility of an accident. If the boat begins to feel unstable or is hard to steer, slow down and/or readjust the trim angle.

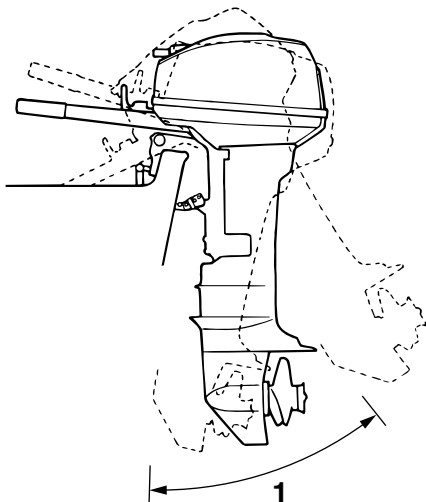

ZMU02858

1. Trim operating angle

EMU27872

## Adjusting trim angle for manual tilt models

There are 4 or 5 holes provided in the clamp bracket to adjust the outboard motor trim angle.

1. Stop the engine.
2. Tilt the outboard motor up, and then remove the trim rod from the clamp bracket.

# Operation

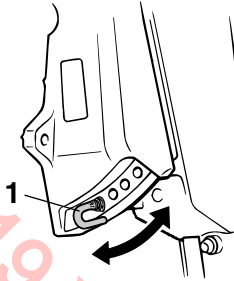

ZMU02909

1. Trim rod

3. Reposition the rod in the desired hole. To raise the bow (“trim-out”), move the rod away from the transom. To lower the bow (“trim-in”), move the rod toward the transom.

Make test runs with the trim set to different angles to find the position that works best for your boat and operating conditions.

EWMM00400

## **WARNING**

- Stop the engine before adjusting the trim angle.
- Use care to avoid being pinched when removing or installing the rod.
- Use caution when trying a trim position for the first time. Increase speed gradually and watch for any signs of instability or control problems. Improper trim angle can cause loss of control.

## **NOTE:**

The outboard motor trim angle can be changed approximately 4 degrees by shifting the trim rod one hole.

EMU27911

## **Adjusting boat trim**

When the boat is on plane, a bow-up attitude results in less drag, greater stability and efficiency. This is generally when the keel line of

the boat is up about 3 to 5 degrees. With the bow up, the boat may have a greater tendency to steer to one side or the other. Compensate for this as you steer. The trim tab can also be adjusted to help offset this effect. When the bow of the boat is down, it is easier to accelerate from a standing start onto plane.

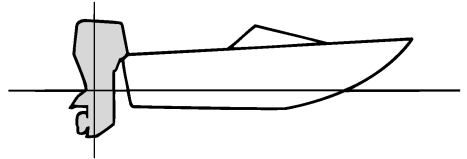

ZMU01784

## **Bow Up**

Too much trim-out puts the bow of the boat too high in the water. Performance and economy are decreased because the hull of the boat is pushing the water and there is more air drag. Excessive trim-out can also cause the propeller to ventilate, which reduces performance further, and the boat may “porpoise” (hop in the water), which could throw the operator and passengers overboard.

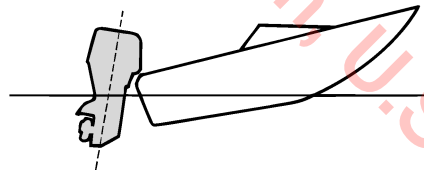

ZMU01785

## **Bow Down**

Too much trim-in causes the boat to “plow” through the water, decreasing fuel economy

and making it hard to increase speed. Operating with excessive trim-in at higher speeds also makes the boat unstable. Resistance at the bow is greatly increased, heightening the danger of “bow steering” and making operation difficult and dangerous.

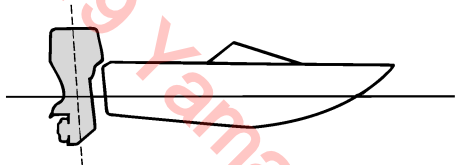

ZMU01786

## NOTE:

Depending on the type of boat, the outboard motor trim angle may have little effect on the trim of the boat when operating.

EMU27933

## Tilting up and down

If the engine will be stopped for some time or if the boat is moored in shallows, the outboard motor should be tilted up to protect the propeller and casing from damage by collision with obstructions, and also to reduce salt corrosion.

EWM00220

## WARNING

Be sure all people are clear of the outboard motor when tilting up and down, also be careful not to pinch any body parts between the drive unit and engine bracket.

EWM00250

## WARNING

Leaking fuel is a fire hazard. If there is a fuel joint on the outboard motor, disconnect the fuel line or close the fuel cock if

the engine will be tilted for more than a few minutes. Otherwise fuel may leak.

ECM00241

## CAUTION:

- Before tilting the outboard motor, stop the engine by following the procedure on page 35. Never tilt the outboard motor while the engine is running. Severe damage from overheating can result.
- Do not tilt up the engine by pushing the tiller handle (if equipped) because this could break the handle.

EMU27953

## Procedure for tilting up (manual tilt models)

1. Place the gear shift lever in neutral.

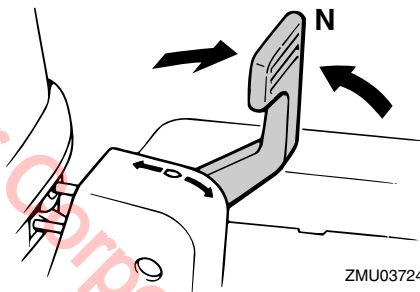

ZMU03724

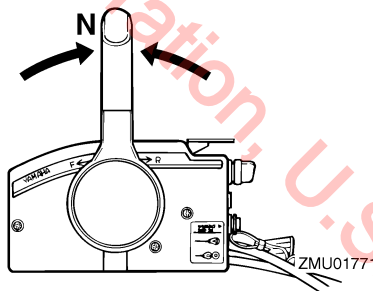

ZMU01771

2. Disconnect the fuel line if a fuel joint is provided on the outboard motor.

# Operation

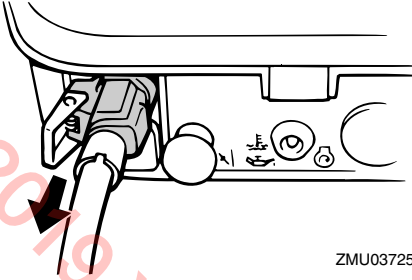

3. Place the tilt lock lever in the release position.

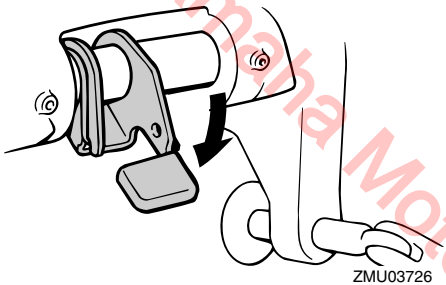
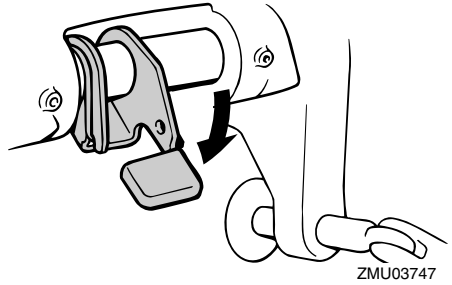

4. Hold the rear of the top cowling with one hand, tilt the engine up, and turn the tilt support lever to the lock position and support the engine.

EMU28022

## Procedure for tilting down (manual tilt models)

1. Place the tilt lock lever in the release/down position or return the shallow water lever to its original position.

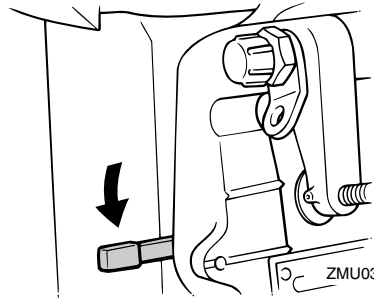

2. Slightly tilt the engine up until the tilt support bar is automatically released.
3. Slowly tilt the engine down.

EMU28060

## Cruising in shallow water

The outboard motor can be tilted up partially to allow operation in shallow water.

EMU28071

## Cruising in shallow water (manual tilt models)

EWMM00710

### **WARNING**

- Place the gear shift in neutral before using the shallow water cruising system.
- Run the boat at the lowest possible speed when using the shallow water cruising system. The tilt lock mechanism does not work while the shallow water cruising system is being used. Hitting an underwater obstacle could cause the outboard motor to lift out of

the water, resulting in loss of control.

- Do not rotate the outboard motor 180° and operate the boat in reverse. Place the gear shift in reverse to operate the boat in reverse.
- Use extra care when operating in reverse. Too much reverse thrust can cause the outboard motor to lift out of the water, increasing the chance of accident and personal injury.
- Return the outboard motor to its normal position as soon as the boat is back in deeper water.

ECM00260

## CAUTION:

Do not tilt the outboard motor up so that the cooling water inlet on the lower unit is above the surface of the water when setting up for and cruising in shallow water. Otherwise severe damage from overheating can result.

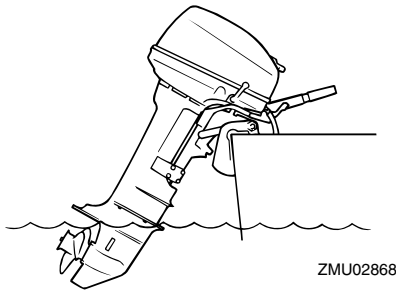

EMU28132

## Procedure

1. Place the gear shift lever in neutral.

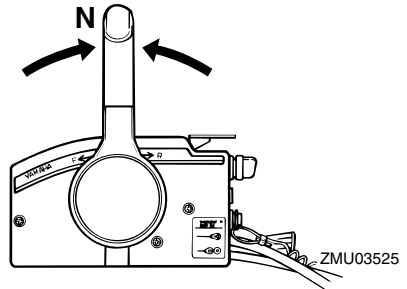
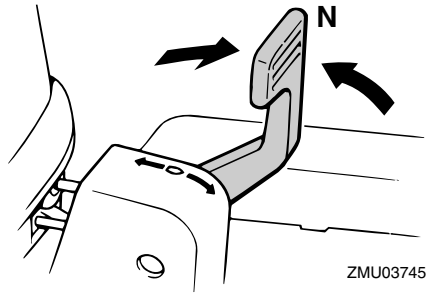

2. Push the tilt lock lever down to release it.

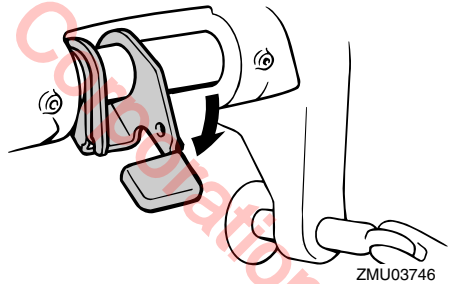

3. Pull up the shallow water lever.

# Operation

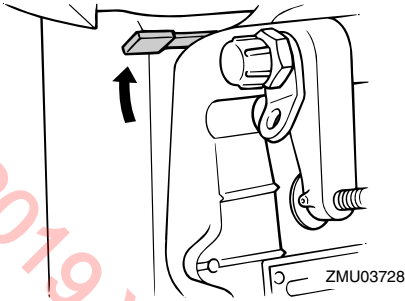

4. Slightly tilt the outboard motor up. The tilt support bar will lock automatically, supporting the outboard motor in a partially raised position.

**NOTE:** \_\_\_\_\_

This outboard motor has 2 positions for shallow water cruising.

5. To return the outboard motor to the normal running position, place the tilt lock lever and shallow water lever to the lock position.

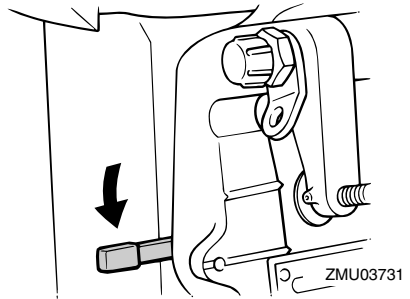
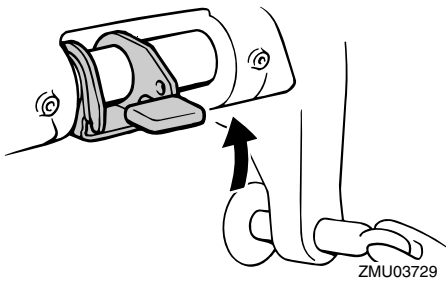

6. Slightly tilt the outboard motor up until the tilt support bar automatically returns to the free position.
7. Slowly lower the outboard motor to the normal position.

EMU28192

## Cruising in other conditions

### Cruising in salt water

After operating in salt water, flush the cooling water passages with fresh water to prevent them from becoming clogged with salt deposits.

**NOTE:** \_\_\_\_\_

For cooling system flushing instructions, see page 43.

### Cruising in turbid water

Yamaha strongly recommends that you use the optional chromium-plated water pump kit (not available for some models) if you use the outboard motor in turbid or muddy water conditions.

EMU31480

## Specifications

### NOTE:

“(AL)” stated in the specification data below represents the numerical value for the aluminum propeller installed.

Likewise, “(SUS)” represents the value for stainless steel propeller installed and “(PL)” for plastic propeller installed.

EMU28218

### Dimension:

Overall length:

25EH 936 mm (36.9 in)

25ER 615 mm (24.2 in)

25MH 936 mm (36.9 in)

Overall width:

25EH 358 mm (14.1 in)

25ER 304 mm (12.0 in)

25MH 358 mm (14.1 in)

Overall height S:

1068 mm (42.0 in)

Overall height L:

1195 mm (47.0 in)

Transom height S:

419 mm (16.5 in)

Transom height L:

546 mm (21.5 in)

Weight (AL) S:

25EH 50.5 kg (111 lb)

25ER 49.5 kg (109 lb)

25MH 48.0 kg (106 lb)

Weight (AL) L:

25EH 52.0 kg (115 lb)

25ER 51.0 kg (112 lb)

25MH 49.5 kg (109 lb)

### Performance:

Full throttle operating range:

5000–6000 r/min

Maximum output:

18.4 kW@5500 r/min (25 HP@5500

r/min)

Idling speed (in neutral):

750 ±50 r/min

### Engine:

Type:

2-stroke L

Displacement:

395.0 cm<sup>3</sup> (24.10 cu.in)

Bore × stroke:

67.0 × 56.0 mm (2.64 × 2.20 in)

Ignition system:

CDI

Spark plug (NGK):

B7HS-10

Spark plug gap:

0.9–1.0 mm (0.035–0.039 in)

Control system:

25EH Tiller

25ER Remote control

25MH Tiller

Starting system:

25EH Manual and electric

25ER Manual and electric

25MH Manual

Starting carburetion system:

Choke valve

Min. cold cranking amps (CCA/SAE):

25EH 245.0 A

25ER 245.0 A

Min. marine cranking amps (MCA/ABYC):

25EH 323.0 A

25ER 323.0 A

Min. reserve capacity (RC/SAE):

25EH 52 minutes

25ER 52 minutes

Alternator output:

25MH 80 W

Alternator output for battery DC:

25EH 6.0 A

25ER 6.0 A

### Drive unit:

# Maintenance

---

Gear positions:

Forward-neutral-reverse

Gear ratio:

2.08 (27/13)

Trim and tilt system:

Manual tilt

Propeller mark:

F

## Fuel and oil:

Recommended fuel:

Regular unleaded gasoline

Min. pump octane:

86

Fuel tank capacity:

25 L (6.60 US gal) (5.50 Imp.gal)

Recommended engine oil:

YAMALUBE 2-stroke outboard motor oil

## Fuel:oil ratio:

Regular gasoline:

100 :1

Lubrication:

Pre-mixed fuel and oil

Recommended gear oil:

Hypoid gear oil SAE#90

Gear oil quantity:

370.0 cm<sup>3</sup> (12.51 US oz) (13.05 Imp.oz)

## Tightening torque for engine:

Spark plug:

25.0 Nm (18.4 ft-lb) (2.55 kgf-m)

Propeller nut:

35.0 Nm (25.8 ft-lb) (3.57 kgf-m)

EMU28222

## Transporting and storing outboard motor

EWM00690



- Leaking fuel is a fire hazard. When transporting and storing the outboard motor, close the air vent screw and fuel

cock to prevent fuel from leaking.

- USE CARE when transporting fuel tank, whether in a boat or car.
- DO NOT fill fuel container to maximum capacity. Gasoline will expand considerably as it warms up and can build up pressure in the fuel container. This can cause fuel leakage and a potential fire hazard.

EWM00700



Never get under the lower unit while it is tilted, even if a motor support bar is used. Severe injury could occur if the outboard motor accidentally falls.

ECM00660



Do not use the tilt support lever or knob when trailering the boat. The outboard motor could shake loose from the tilt support and fall. If the motor cannot be trailered in the normal running position, use an additional support device to secure it in the tilt position.

The outboard motor should be trailered and stored in the normal running position. If there is insufficient road clearance in this position, then trailer the outboard motor in the tilt position using a motor support device such as a transom saver bar. Consult your Yamaha dealer for further details.



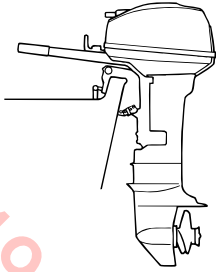

ZMU02870

EMU28235

## Clamp screw mounting models

When transporting or storing the outboard motor while removed from a boat, keep the outboard motor in the attitude shown.

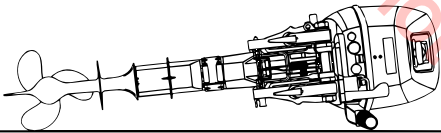

ZMU02869

### NOTE:

Place a towel or something similar under the outboard motor to protect it from damage.

EMU30272

## Storing outboard motor

When storing your Yamaha outboard motor for prolonged periods of time (2 months or longer), several important procedures must be performed to prevent excessive damage. It is advisable to have your outboard motor serviced by an authorized Yamaha dealer prior to storage. However, you, the owner, with a minimum of tools, can perform the fol-

lowing procedures.

ECM01411

### CAUTION:

- Do not place the outboard motor on its side before the cooling water has drained from it completely, otherwise water may enter the cylinder through the exhaust port and cause engine trouble.
- Store the outboard motor in a dry, well-ventilated place, not in direct sunlight.

EMU28302

## Procedure

EMU28372

### Flushing in a test tank

1. Wash the outboard motor body using fresh water. For further information, see page 46.
2. Fill the fuel tank with fresh fuel and add one ounce of "Yamaha Fuel Conditioner and Stabilizer" (Part No. LUB-FUELC-12-00) to each gallon of fuel.

### NOTE:

The use of "Yamaha Fuel Conditioner and Stabilizer" eliminates the need to drain the fuel system. Consult your Yamaha dealer or other qualified mechanic if the fuel system is to be drained instead.

3. Remove the engine top cowling and silencer cover.
4. Install the outboard motor on the test tank.

# Maintenance

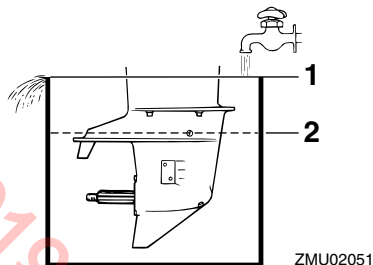

1. Water surface
2. Lowest water level

5. Fill the tank with fresh water to above the level of the anti-cavitation plate.

ECM00300

## CAUTION:

**Do not run the engine without supplying it with cooling water. Either the engine water pump will be damaged or the engine will be damaged from overheating. Before starting the engine, be sure to supply water to the cooling water passages.**

ECM00290

## CAUTION:

**If the fresh water level is below the level of the anti-cavitation plate, or if the water supply is insufficient, engine seizure may occur.**

6. Cooling system flushing is essential to prevent the cooling system from clogging up with salt, sand, or dirt. In addition, fogging of the engine is mandatory to prevent excessive engine damage due to rust. Perform the flushing and fogging at the same time.

EWM00090

## WARNING

- Do not touch or remove electrical parts

when starting or during operation.

- Keep hands, hair, and clothes away from the flywheel and other rotating parts while the engine is running.

7. Run the engine at a fast idle for 10–15 minutes in neutral position.
8. Just prior to turning off the engine, quickly spray “Yamaha Stor-Rite Engine Fogging Oil” (Part No. LUB-STRRT-12-00) alternately into each carburetor or the fogging hole of the silencer cover, if equipped. When properly done, the engine will smoke excessively and almost stall.
9. Remove the outboard motor from the test tank.
10. Drain the cooling water completely out of the motor. Clean the body thoroughly.
11. Install the silencer cover/cap and top cowling.

EMU28400

## Lubrication (except oil injection models)

1. Grease the spark plug threads and install the spark plug(s) and torque to proper specification. For information on spark plug installation, see page 50.
2. Change the gear oil. For instructions, see page 54. Inspect the oil for the presence of water that indicates a leaky seal. Seal replacement should be performed by an authorized Yamaha dealer prior to use.
3. Grease all grease fittings. For further details, see page 49.

EMU28421

## Cleaning and anticorrosion measures

1. Wash down the exterior of the outboard motor with fresh water and dry off completely.

2. Spray the outboard motor exterior with “Yamaha Silicone Protectant” (Part No. LUB-SILCNE-13-00).
3. Wax the cowling with a non-abrasive wax such as “Yamaha Silicone Wax” (Part No. ACC-11000-15-02).

EMU28430

## Battery care

EWM00330



**Battery electrolytic fluid is dangerous; it contains sulfuric acid and therefore is poisonous and highly caustic.**

**Always follow these preventive measures:**

- Avoid bodily contact with electrolytic fluid as it can cause severe burns or permanent eye injury.
- Wear protective eye gear when handling or working near batteries.

### Antidote (EXTERNAL):

- SKIN - Flush with water.
- EYES - Flush with water for 15 minutes and get immediate medical attention.

### Antidote (INTERNAL):

- Drink large quantities of water or milk followed by milk of magnesia, beaten egg, or vegetable oil. Get immediate medical attention.

Batteries also generate explosive hydrogen gas; therefore, you should always follow these preventive measures:

- Charge batteries in a well-ventilated area.
- Keep batteries away from fire, sparks, or open flames (for example: welding equipment, lighted cigarettes, and so on.)
- DO NOT SMOKE when charging or handling batteries.

**KEEP BATTERIES AND ELECTROLYTIC**

## FLUID OUT OF REACH OF CHILDREN.

Batteries vary among manufacturers. Therefore the following procedures may not always apply. Consult your battery manufacturer’s instructions.

### Procedure

1. Disconnect and remove the battery from the boat. Always disconnect the black negative cable first to prevent the risk of shorting.
2. Clean the battery casing and terminals. Fill each cell to the upper level with distilled water.
3. Store the battery on a level surface in a cool, dry, well-ventilated place out of direct sunlight.
4. Once a month, check the specific gravity of the electrolyte and recharge as required to prolong battery life.

EMU28450

## Cleaning the outboard motor

After use, wash the exterior of the outboard motor with fresh water. Flush the cooling system with fresh water.

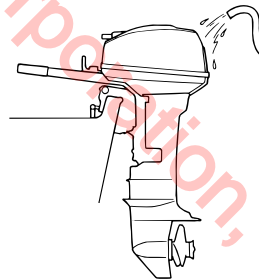

ZMU02871

### NOTE:

For cooling system flushing instructions, see page 43.

EMU28460

## Checking painted surface of motor

Check the motor for scratches, nicks, or flak-

# Maintenance

---

ing paint. Areas with damaged paint are more likely to corrode. If necessary, clean and paint the areas. A touch-up paint is available from your Yamaha dealer.

EMU28486

## Periodic maintenance

EWM01070



**Be sure to turn off the engine when you perform maintenance unless otherwise specified. If you or the owner is not familiar with machine servicing, this work should be done by your Yamaha dealer or other qualified mechanic.**

**Maintenance, replacement, or repair of the emission control devices and systems may be performed by any marine engine repair establishment or individual. All warranty repairs, however, including those to the emission control system, must be performed by an authorized Yamaha marine dealership.**

A service manual is available for purchase through your Yamaha dealer for owners who have the mechanical skills, tools, and other equipment necessary to perform maintenance not covered by this owner's manual.

EMU28510

## Replacement parts

If replacement parts are necessary, use only genuine Yamaha parts or parts of the same type and of equivalent strength and materials. Any part of inferior quality may malfunction, and the resulting loss of control could endanger the operator and passengers. Yamaha genuine parts and accessories are available from your Yamaha dealer.

EMU28522

## Maintenance chart

Frequency of maintenance operations may be adjusted according to the operating conditions, but the following table gives general guidelines. Refer to the sections in this chapter for explanations of each owner-specific action.

### NOTE:

When operating in salt water, turbid or muddy water, the engine should be flushed with clean water after each use.

The “●” symbol indicates the check-ups which you may carry out yourself.

The “○” symbol indicates work to be carried out by your Yamaha dealer.

Item	Actions	Initial		Every	
		10 hours (1 month)	50 hours (3 months)	100 hours (6 months)	200 hours (1 year)
Anode(s) (external)	Inspection / replacement		●/○	●/○	
Anode(s) (internal)	Inspection / replacement				○
Battery	Inspection / charging	●/○			
Cooling water passages	Cleaning		●	●	
Cowling clamp	Inspection				●
Fuel filter (can be disassembled)	Inspection / cleaning	●	●	●	
Fuel system	Inspection	●	●	●	
Fuel tank (Yamaha portable tank)	Inspection / cleaning				●
Gear oil	Change	●		●	
Greasing points	Greasing			●	
Idling speed (carburetor models)	Inspection	●/○		●/○	
Propeller and cotter pin	Inspection / replacement		●	●	
Shift link / shift cable	Inspection / adjustment				○
Thermostat	Inspection / replacement				○
Throttle link / throttle cable / throttle pick-up timing	Inspection / adjustment				○
Water pump	Inspection / replacement				○

# Maintenance

Item	Actions	Initial		Every	
		10 hours (1 month)	50 hours (3 months)	100 hours (6 months)	200 hours (1 year)
Spark plug(s)	Cleaning / adjustment / replacement	●	●	●	

EMU28931

## Greasing

Yamaha marine grease (Water resistant grease)

25

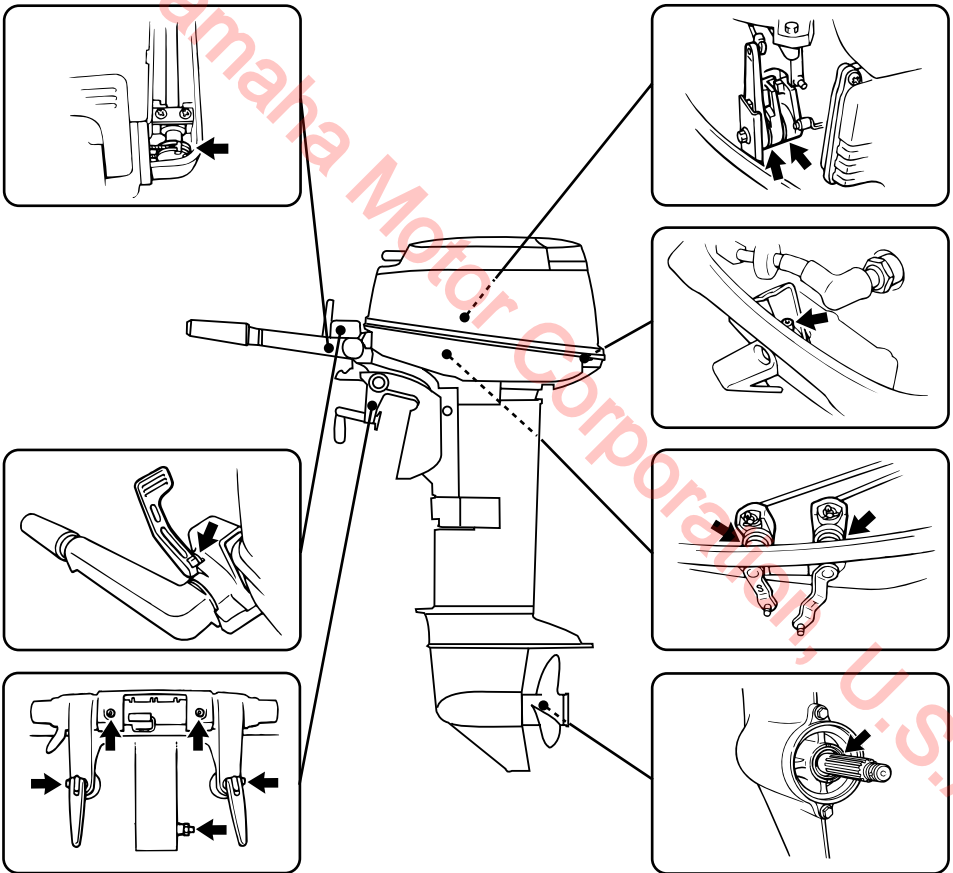

ZMU03734

EMU28952

## Cleaning and adjusting spark plug

EWM00560

### **WARNING**

When removing or installing a spark plug, be careful not to damage the insulator. A damaged insulator could allow external sparks, which could lead to explosion or fire.

The spark plug is an important engine component and is easy to inspect. The condition of the spark plug can indicate something about the condition of the engine. For example, if the center electrode porcelain is very white, this could indicate an intake air leak or carburetion problem in that cylinder. Do not attempt to diagnose any problems yourself. Instead, take the outboard motor to a Yamaha dealer. You should periodically remove and inspect the spark plug because heat and deposits will cause the spark plug to slowly break down and erode. If electrode erosion becomes excessive, or if carbon and other deposits are excessive, you should replace the spark plug with another of the correct type.

Standard spark plug:  
B7HS-10

Before fitting the spark plug, measure the electrode gap with a wire thickness gauge; adjust the gap to specification if necessary.

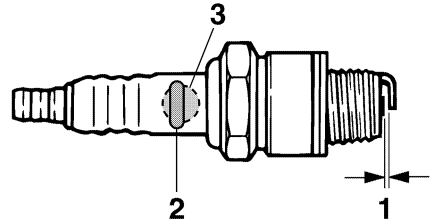

ZMU02179

1. Spark plug gap
2. Spark plug I.D. mark (NGK)
3. Spark plug part number

Spark plug gap:  
0.9–1.0 mm (0.035–0.039 in)

When fitting the plug, always clean the gasket surface and use a new gasket. Wipe off any dirt from the threads and screw in the spark plug to the correct torque.

Spark plug torque:  
25.0 Nm (18.4 ft-lb) (2.55 kgf-m)

### **NOTE:**

If a torque-wrench is not available when you are fitting a spark plug, a good estimate of the correct torque is 1/4 to 1/2 a turn past finger-tight. Have the spark plug adjusted to the correct torque as soon as possible with a torque-wrench.

EMU28962

## Checking fuel system

EWM00060

### **WARNING**

Gasoline and its vapors are highly flammable and explosive. Keep away from sparks, cigarettes, flames, or other

# Maintenance

## sources of ignition.

EWM00910

### **WARNING**

Leaking fuel can result in fire or explosion.

- Check for fuel leakage regularly.
- If any fuel leakage is found, the fuel system must be repaired by a qualified mechanic. Improper repairs can make the outboard unsafe to operate.

Check the fuel lines for leaks, crack, or malfunction. If a problem is found, your Yamaha dealer or other qualified mechanic should repair it immediately.

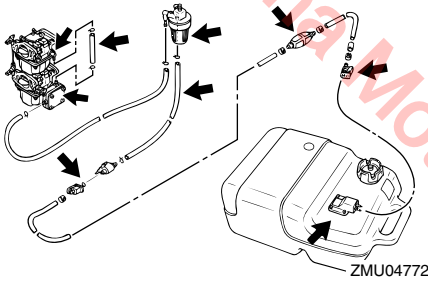

## Checkpoints

- Fuel system parts leakage
- Fuel line joint leakage
- Fuel line cracks or other damage
- Fuel connector leakage

EMU28980

## Inspecting fuel filter

EWM00310

### **WARNING**

Gasoline is highly flammable, and its vapors are flammable and explosive.

- If you have any question about properly doing this procedure, consult your Yamaha dealer.
- Do not perform this procedure on a hot or running engine. Allow the engine to

cool.

- There will be fuel in the fuel filter. Keep away from sparks, cigarettes, flames or other sources of ignition.
- This procedure will allow some fuel to spill. Catch fuel in a rag. Wipe up any spilled fuel immediately.
- The fuel filter must be reassembled carefully with the O-ring, filter cup, and hoses in place. Improper assembly or replacement could result in a fuel leak, which could result in a fire or explosion hazard.

EMU29001

## Cleaning fuel filter

1. Remove the nut holding the fuel filter assembly if equipped.

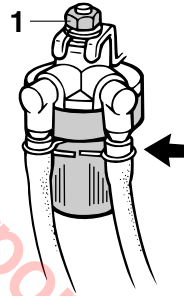

1. Nut

2. Unscrew the filter cup, catching any spilled fuel in a rag.
3. Remove the filter element, and wash it in solvent. Allow it to dry. Inspect the filter element and O-ring to make sure they are in good condition. Replace them if necessary. If any water is found in the fuel, the Yamaha portable fuel tank or other fuel tanks should be checked and cleaned.



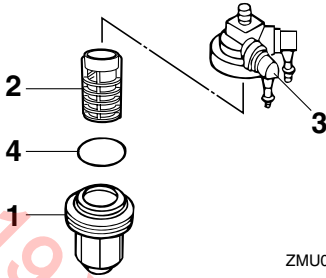

ZMU02079

1. Filter cup
  2. Filter element
  3. Filter housing
  4. O-ring
4. Reinstall the filter element in the cup. Make sure the O-ring is in position in the cup. Firmly screw the cup onto the filter housing.
  5. Attach the filter assembly to the bracket so that the fuel hoses are attached to the filter assembly.
  6. Run the engine and check the filter and lines for leaks.

EMU29041

## Inspecting idling speed

EWM00451

### **WARNING**

- Do not touch or remove electrical parts when starting or during operation.
- Keep hands, hair, and clothes away from the flywheel and other rotating parts while the engine is running.

ECM00490

### **CAUTION:**

**This procedure must be performed while the outboard motor is in the water. A flushing attachment or test tank can be used.**

A diagnostic tachometer should be used for this procedure. Results may vary depending

on whether testing is conducted with the flushing attachment, in a test tank, or with the outboard motor in the water.

1. Start the engine and allow it to warm up fully in neutral until it is running smoothly.

### **NOTE:**

Correct idling speed inspection is only possible if the engine is fully warmed up. If not warmed up fully, the idle speed will measure higher than normal. If you have difficulty verifying the idle speed, or the idle speed requires adjustment, consult a Yamaha dealer or other qualified mechanic.

2. Verify whether the idle speed is set to specification. For idle speed specifications, see page 42.

EMU29112

## Checking wiring and connectors

- Check that each grounding wire is properly secured.
- Check that each connector is engaged securely.

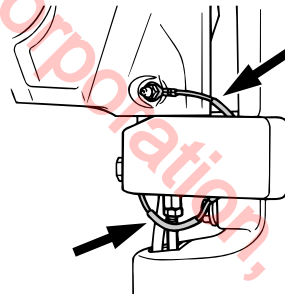

ZMU03737

EMU29120

## Exhaust leakage

Start the engine and check that no exhaust leaks from the joints between the exhaust cover, cylinder head, and body cylinder.

EMU29130

## Water leakage

Start the engine and check that no water

# Maintenance

leaks from the joints between the exhaust cover, cylinder head, and body cylinder.

EMU29171

## Checking propeller

EWM00321

### **WARNING**

You could be seriously injured if the engine accidentally starts when you are near the propeller.

- Before inspecting, removing, or installing the propeller, remove the spark plug caps from the spark plugs. Also, place the shift control in neutral, turn the main switch to “OFF” (off) and remove the key, and remove the lanyard from the engine stop switch. Turn off the battery cut-off switch if your boat has one.
- Do not use your hand to hold the propeller when loosening or tightening the propeller nut. Put a wood block between the anti-cavitation plate and the propeller to prevent the propeller from turning.

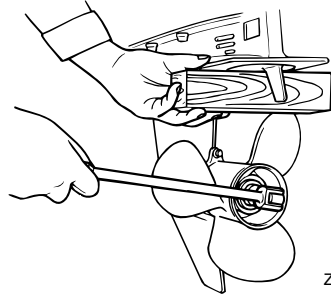
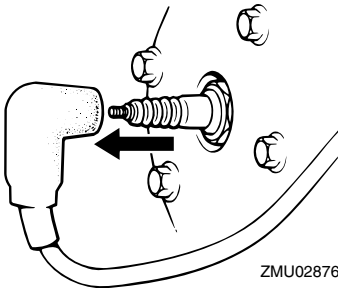

### Checkpoints

- Check each of the propeller blades for wear, erosion from cavitation or ventilation, or other damage.
- Check the propeller shaft for damage.
- Check the splines / shear pin for wear or damage.
- Check for fish line tangled around the propeller shaft.

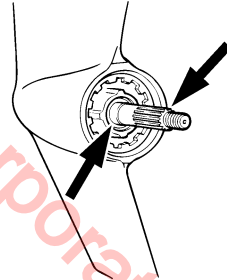

- Check the propeller shaft oil seal for damage.

### **NOTE:**

If the shear pin equipped: it is designed to break if the propeller hits a hard underwater obstacle to help protect the propeller and drive mechanism. The propeller will then spin freely on the shaft. If this happens, the shear pin must be replaced.

EMU30660

## Removing the propeller

EMU29194

### Spline models

1. Straighten the cotter pin and pull it out using a pair of pliers.
2. Remove the propeller nut, washer, and spacer (if equipped).

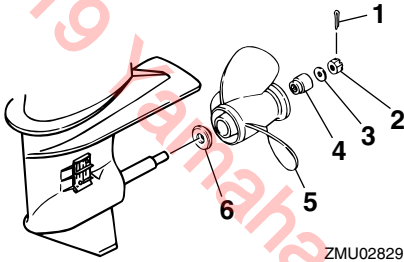

1. Cotter pin
2. Propeller nut
3. Washer
4. Spacer
5. Propeller
6. Thrust washer

3. Remove the propeller and thrust washer.

EMU30670

## Installing the Propeller

EMU29231

### Spline models

ECM00340

### CAUTION:

- Be sure to install the thrust washer before installing the propeller, otherwise the lower case and propeller boss could be damaged.
- Be sure to use a new cotter pin and bend the ends over securely. Otherwise the propeller could come off during operation and be lost.

1. Apply Yamaha marine grease or a cor-

rosion resistant grease to the propeller shaft.

2. Install the spacer (if equipped), thrust washer, and propeller on the propeller shaft.
3. Install the spacer (if equipped) and the washer. Tighten the propeller nut to the specified torque.
4. Align the propeller nut with the propeller shaft hole. Insert a new cotter pin in the hole and bend the cotter pin ends.

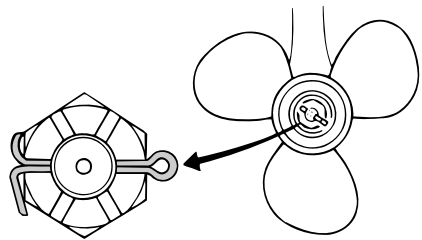

ZMU02063

### NOTE:

If the propeller nut does not align with the propeller shaft hole after tightening to the specified torque, tighten the nut further to align it with the hole.

EMU29282

## Changing gear oil

EWM00800

### WARNING

- Be sure the outboard motor is securely fastened to the transom or a stable stand. You could be severely injured if the outboard motor falls on you.
- Never get under the lower unit while it is tilted, even when the tilt support lever or knob is locked. Severe injury could occur if the outboard motor accidentally falls.

1. Tilt the outboard motor so that the gear

# Maintenance

oil drain screw is at the lowest point possible.

2. Place a suitable container under the gear case.
3. Remove the gear oil drain screw and gasket.

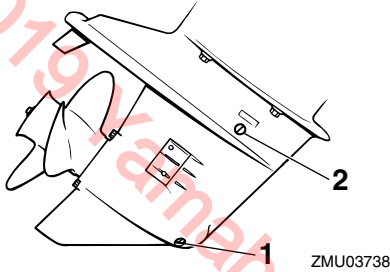

1. Gear oil drain screw
2. Oil level plug

## NOTE:

- If a magnetic gear oil drain screw is equipped, remove all metal particles from the screw before installing it.
- Always use new gaskets. Do not reuse the removed gaskets.

4. Remove the oil level plug and gasket to allow the oil to drain completely.

ECM00710

## CAUTION:

Inspect the used oil after it has been drained. If the oil is milky, water is getting into the gear case which can cause gear damage. Consult a Yamaha dealer for repair of the lower unit seals.

## NOTE:

For disposal of used oil, consult your Yamaha dealer.

5. With the outboard motor in a vertical position, and using a flexible or pressur-

ized filling device, inject the gear oil into the gear oil drain screw hole.

Recommended gear oil:

Hypoid gear oil SAE#90

Gear oil quantity:

370.0 cm<sup>3</sup> (12.51 US oz) (13.05 Imp.oz)

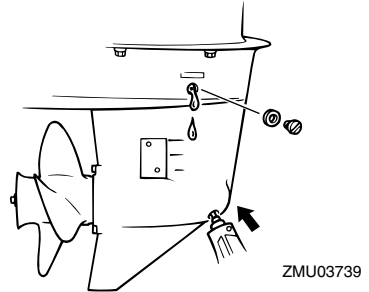

6. Put a new gasket on the oil level plug. When the oil begins to flow out of the oil level plug hole, insert and tighten the oil level plug.
7. Put a new gasket on the gear oil drain screw. Insert and tighten the gear oil drain screw.

EMU29302

## Cleaning fuel tank

EWM00920

## WARNING

Gasoline is highly flammable, and its vapors are flammable and explosive.

- If you have any question about properly doing this procedure, consult your Yamaha dealer.
- Keep away from sparks, cigarettes, flames, or other sources of ignition when cleaning the fuel tank.
- Remove the fuel tank from the boat before cleaning it. Work only outdoors in

an area with good ventilation.

- Wipe up any spilled fuel immediately.
- Reassemble the fuel tank carefully. Improper assembly can result in a fuel leak, which could result in a fire or explosion hazard.
- Dispose of old gasoline according to local regulations.

1. Empty the fuel tank into an approved container.
2. Pour a small amount of suitable solvent into the tank. Install the cap and shake the tank. Drain the solvent completely.
3. Remove the screws holding the fuel joint assembly. Pull the assembly out of the tank.

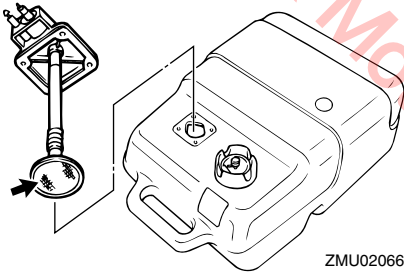

4. Clean the filter (located on the end of the suction pipe) in a suitable cleaning solvent. Allow the filter to dry.
5. Replace the gasket with a new one. Reinstall the fuel joint assembly and tighten the screws firmly.

EMU29312

## Inspecting and replacing anode(s)

Yamaha outboard motors are protected from corrosion by sacrificial anodes. Inspect the external anodes periodically. Remove scales from the surfaces of the anodes. Consult a Yamaha dealer for replacement of external

anodes.

ECM00720

## CAUTION:

Do not paint anodes, as this would render them ineffective.

## NOTE:

Inspect ground leads attached to external anodes on equipped models. Consult a Yamaha dealer for inspection and replacement of internal anodes attached to the power unit.

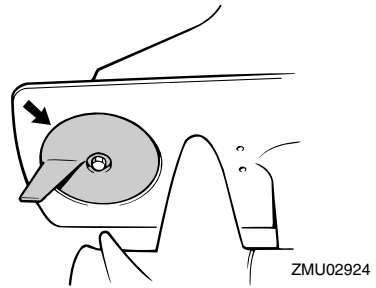

EMU29320

## Checking battery (for electric start models)

EWM00330

## WARNING

Battery electrolytic fluid is dangerous; it contains sulfuric acid and therefore is poisonous and highly caustic.

Always follow these preventive measures:

- Avoid bodily contact with electrolytic fluid as it can cause severe burns or permanent eye injury.
- Wear protective eye gear when handling or working near batteries.

## Antidote (EXTERNAL):

- SKIN - Flush with water.
- EYES - Flush with water for 15 minutes

# Maintenance

---

and get immediate medical attention.

**Antidote (INTERNAL):**

- Drink large quantities of water or milk followed by milk of magnesia, beaten egg, or vegetable oil. Get immediate medical attention.

Batteries also generate explosive hydrogen gas; therefore, you should always follow these preventive measures:

- Charge batteries in a well-ventilated area.
- Keep batteries away from fire, sparks, or open flames (for example: welding equipment, lighted cigarettes, and so on.)
- **DO NOT SMOKE** when charging or handling batteries.

**KEEP BATTERIES AND ELECTROLYTIC FLUID OUT OF REACH OF CHILDREN.**

ECM00360

## CAUTION:

- A poorly maintained battery will quickly deteriorate.
- Ordinary tap water contains minerals harmful to a battery, and should not be used for topping up.

1. Check the electrolyte level at least once a month. Fill to the manufacturer's recommended level when necessary. Top up only with distilled water (or pure de-ionized water suitable to use in batteries).

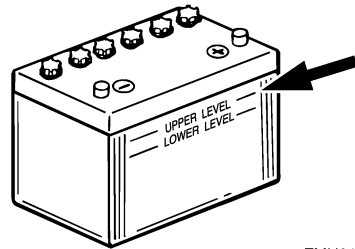

ZMU01810

2. Always keep the battery in a good state of charge. Installing a voltmeter will help you monitor your battery. If you will not use the boat for a month or more, remove the battery from the boat and store it in a cool, dark place. Completely recharge the battery before using it.
3. If the battery will be stored for longer than a month, check the specific gravity of the fluid at least once a month and recharge the battery when it is low.

## NOTE:

Consult a Yamaha dealer when charging or re-charging batteries.

EMU29331

## Connecting the battery

EWM00570



**Mount the battery holder securely in a dry, well-ventilated, vibration-free location in the boat. Install a fully charged battery in the holder.**

ECM01121

## CAUTION:

- Make sure the main switch (on applicable models) is "OFF" (off) before working on the battery.
- Reversal of the battery cables will damage the electrical parts.
- Connect the red battery cable first

when installing the battery and disconnect the black battery cable first when removing it. Otherwise, the electrical parts can be damaged.

- The electrical contacts of the battery and cables must be clean and properly connected, or the battery will not start the engine.

Connect the red battery cable to the POSITIVE (+) terminal first. Then connect the black battery cable to the NEGATIVE (-) terminal.

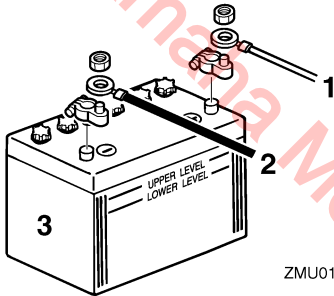

ZMU01811

1. Red cable
2. Black cable
3. Battery

EMU29370

## Disconnecting the battery

Disconnect the BLACK cable from the NEGATIVE (-) terminal first. Then disconnect the RED cable from the POSITIVE (+) terminal.

EMU29390

## Checking top cowling

Check the fitting of the top cowling by pushing it with both hands. If it is loose have it repaired by your Yamaha dealer.

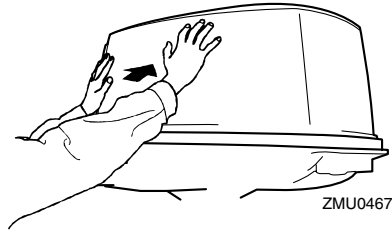

ZMU04677

EMU29400

## Coating the boat bottom

A clean hull improves boat performance. The boat bottom should be kept as clean of marine growth as possible. If necessary, the boat bottom can be coated with an anti-fouling paint approved for your area to inhibit marine growth.

Do not use anti-fouling paint which includes copper or graphite. These paints can cause more rapid engine corrosion.

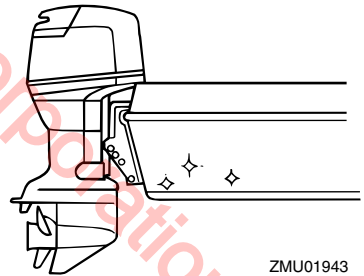

ZMU01943

# Trouble Recovery

---

EMU29424

## Troubleshooting

A problem in the fuel, compression, or ignition systems can cause poor starting, loss of power, or other problems. This section describes basic checks and possible remedies, and covers all Yamaha outboard motors. Therefore some items may not apply to your model.

If your outboard motor requires repair, bring it to your Yamaha dealer.

If the engine trouble warning indicator is flashing, consult your Yamaha dealer.

### **Starter will not operate.**

Q. Is battery capacity weak or low?

A. Check battery condition. Use battery of recommended capacity.

Q. Are battery connections loose or corroded?

A. Tighten battery cables and clean battery terminals.

Q. Is fuse for electric start relay or electric circuit blown?

A. Check for cause of electric overload and repair. Replace fuse with one of correct amperage.

Q. Are starter components faulty?

A. Have serviced by a Yamaha dealer.

Q. Is shift lever in gear?

A. Shift to neutral.

### **Engine will not start (starter operates).**

Q. Is fuel tank empty?

A. Fill tank with clean, fresh fuel.

Q. Is fuel contaminated or stale?

A. Fill tank with clean, fresh fuel.

Q. Is fuel filter clogged?

A. Clean or replace filter.

Q. Is starting procedure incorrect?

A. See page 26.

Q. Has fuel pump malfunctioned?

A. Have serviced by a Yamaha dealer.

Q. Are spark plug(s) fouled or of incorrect type?

A. Inspect spark plug(s). Clean or replace with recommended type.

Q. Are spark plug cap(s) fitted incorrectly?

A. Check and re-fit cap(s).

Q. Is ignition wiring damaged or poorly connected?

A. Check wires for wear or breaks. Tighten all loose connections. Replace worn or broken wires.

Q. Are ignition parts faulty?

A. Have serviced by a Yamaha dealer.

Q. Is engine stop switch lanyard not attached?

A. Attach lanyard.

Q. Are engine inner parts damaged?

A. Have serviced by a Yamaha dealer.

### **Engine idles irregularly or stalls.**

Q. Are spark plug(s) fouled or of incorrect type?

A. Inspect spark plug(s). Clean or replace with recommended type.



# Trouble Recovery

Q. Is fuel system obstructed?

A. Check for pinched or kinked fuel line or other obstructions in fuel system.

Q. Is fuel contaminated or stale?

A. Fill tank with clean, fresh fuel.

Q. Is fuel filter clogged?

A. Clean or replace filter.

Q. Have ignition parts failed?

A. Have serviced by a Yamaha dealer.

Q. Has warning system activated?

A. Find and correct cause of warning.

Q. Is spark plug gap incorrect?

A. Inspect and adjust as specified.

Q. Is ignition wiring damaged or poorly connected?

A. Check wires for wear or breaks. Tighten all loose connections. Replace worn or broken wires.

Q. Is specified engine oil not being used?

A. Check and replace oil as specified.

Q. Is thermostat faulty or clogged?

A. Have serviced by a Yamaha dealer.

Q. Are carburetor adjustments incorrect?

A. Have serviced by a Yamaha dealer.

Q. Is fuel pump damaged?

A. Have serviced by a Yamaha dealer.

Q. Is air vent screw on fuel tank closed?

A. Open air vent screw.

Q. Is choke knob pulled out?

A. Return to home position.

Q. Is motor angle too high?

A. Return to normal operating position.

Q. Is carburetor clogged?

A. Have serviced by a Yamaha dealer.

Q. Is fuel joint connection incorrect?

A. Connect correctly.

Q. Is throttle valve adjustment incorrect?

A. Have serviced by a Yamaha dealer.

Q. Is battery cable disconnected?

A. Connect securely.

## **Warning buzzer sounds or indicator lights.**

Q. Is cooling system clogged?

A. Check water intake for restriction.

Q. Is engine oil level low?

A. Fill oil tank with specified engine oil.

Q. Is heat range of spark plug incorrect?

A. Inspect spark plug and replace it with recommended type.

Q. Is specified engine oil not being used?

A. Check and replace oil with specified type.

Q. Is engine oil contaminated or deteriorated?

A. Replace oil with fresh, specified type.

Q. Is oil filter clogged?

A. Have serviced by a Yamaha dealer.

Q. Has oil feed/injection pump malfunctioned?

# Trouble Recovery

---

A. Have serviced by a Yamaha dealer.

Q. Is load on boat improperly distributed?

A. Distribute load to place boat on an even plane.

Q. Is water pump or thermostat faulty?

A. Have serviced by a Yamaha dealer.

Q. Is there excess water in fuel filter cup?

A. Drain filter cup.

## Engine power loss.

Q. Is propeller damaged?

A. Have propeller repaired or replaced.

Q. Is propeller pitch or diameter incorrect?

A. Install correct propeller to operate outboard at its recommended speed (r/min) range.

Q. Is trim angle incorrect?

A. Adjust trim angle to achieve most efficient operation.

Q. Is motor mounted at incorrect height on transom?

A. Have motor adjusted to proper transom height.

Q. Has warning system activated?

A. Find and correct cause of warning.

Q. Is boat bottom fouled with marine growth?

A. Clean boat bottom.

Q. Are spark plug(s) fouled or of incorrect type?

A. Inspect spark plug(s). Clean or replace with recommended type.

Q. Are weeds or other foreign matter tangled on gear housing?

A. Remove foreign matter and clean lower unit.

Q. Is fuel system obstructed?

A. Check for pinched or kinked fuel line or other obstructions in fuel system.

Q. Is fuel filter clogged?

A. Clean or replace filter.

Q. Is fuel contaminated or stale?

A. Fill tank with clean, fresh fuel.

Q. Is spark plug gap incorrect?

A. Inspect and adjust as specified.

Q. Is ignition wiring damaged or poorly connected?

A. Check wires for wear or breaks. Tighten all loose connections. Replace worn or broken wires.

Q. Have electrical parts failed?

A. Have serviced by a Yamaha dealer.

Q. Is specified fuel not being used?

A. Replace fuel with specified type.

Q. Is specified engine oil not being used?

A. Check and replace oil with specified type.

Q. Is thermostat faulty or clogged?

A. Have serviced by a Yamaha dealer.

Q. Is air vent screw closed?

A. Open the air vent screw.

Q. Is fuel pump damaged?

A. Have serviced by a Yamaha dealer.

# Trouble Recovery

Q. Is fuel joint connection incorrect?

A. Connect correctly.

Q. Is heat range of spark plug incorrect?

A. Inspect spark plug and replace it with recommended type.

Q. Is high pressure fuel pump drive belt broken?

A. Have serviced by a Yamaha dealer.

Q. Is engine not responding properly to shift lever position?

A. Have serviced by a Yamaha dealer.

## Engine vibrates excessively.

Q. Is propeller damaged?

A. Have propeller repaired or replaced.

Q. Is propeller shaft damaged?

A. Have serviced by a Yamaha dealer.

Q. Are weeds or other foreign matter tangled on propeller?

A. Remove and clean propeller.

Q. Is motor mounting bolt loose?

A. Tighten bolt.

Q. Is steering pivot loose or damaged?

A. Tighten or have serviced by a Yamaha dealer.

EMU29432

## Temporary action in emergency

EMU29440

### Impact damage

EWM00870



The outboard motor can be seriously

**damaged by a collision while operating or trailering. Damage could make the outboard motor unsafe to operate.**

If the outboard motor hits an object in the water, follow the procedure below.



1. Stop the engine immediately.
2. Inspect the control system and all components for damage. Also inspect the boat for damage.
3. Whether damage is found or not, return to the nearest harbor slowly and carefully.
4. Have a Yamaha dealer inspect the outboard motor before operating it again.

EMU29462

### Replacing fuse

If the fuse has blown on an electric start model, open the fuse holder and replace the fuse with a new one of the proper amperage.

EWM00630



**Be sure to use the specified fuse. An incorrect fuse or a piece of wire could allow excessive current flow. This could cause electric system damage and a fire hazard.**

# Trouble Recovery

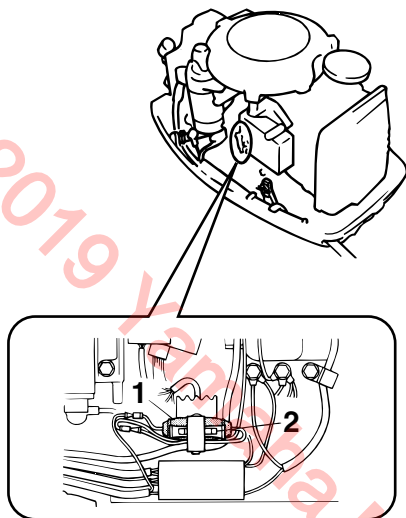

ZMU04839

1. Fuse holder
2. Fuse (10 A)

## NOTE:

Consult your Yamaha dealer if the new fuse immediately blows again.

EMU29532

## Starter will not operate

If the starter mechanism does not operate (the engine cannot be cranked with the starter), the engine can be started with an emergency starter rope.

EWMO1021

## **WARNING**

- Use this procedure only in an emergency to return to the nearest port for repairs.
- When the emergency starter rope is used to start the engine, the start-in-gear protection device does not operate. Make sure the remote control lever

is in neutral. Otherwise the boat could unexpectedly start to move, which could result in an accident.

- Attach the engine stop switch lanyard to a secure place on your clothing, or your arm or leg while operating the boat.
- Do not attach the lanyard to clothing that could tear loose. Do not route the cord where it could become entangled, preventing it from functioning.
- Avoid accidentally pulling the lanyard during normal operation. Loss of engine power means the loss of most steering control. Also, without engine power, the boat could slow rapidly. This could cause people and objects in the boat to be thrown forward.
- Make sure no one is standing behind you when pulling the starter rope. It could whip behind you and injure someone.
- An unguarded, rotating flywheel is very dangerous. Keep loose clothing and other objects away when starting the engine. Use the emergency starter rope only as instructed. Do not touch the flywheel or other moving parts when the engine is running. Do not install the starter mechanism or top cowling after the engine is running.
- Do not touch the ignition coil, spark plug wire, spark plug cap, or other electrical components when starting or operating the motor. You could get an electrical shock.

EMU29561

## Emergency starting engine

1. Remove the top cowling.
2. Remove the start-in-gear protection cable from the starter, if equipped.

# Trouble Recovery

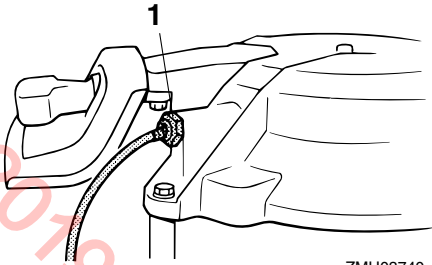

ZMU03740

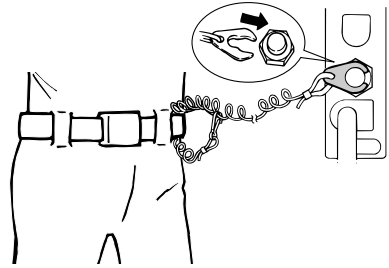

ZMU02334

1. Start-in-gear protection cable
3. Remove the starter/flywheel cover after removing the bolt(s).

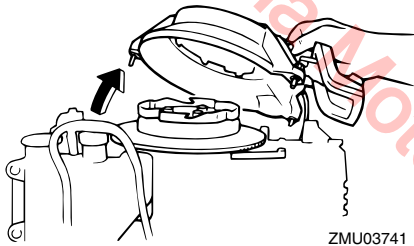

ZMU03741

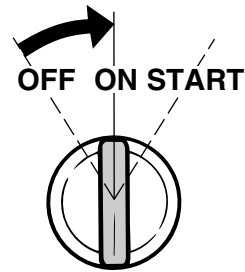

ZMU01906

4. Prepare the engine for starting. For further information, see page 26. Be sure the engine is in neutral and that the engine stop switch lanyard lock plate is attached to the engine stop switch. The main switch must be "ON" (on), if equipped.

5. If equipped the choke knob, pull out when the engine is cold. After the engine starts, gradually return the choke knob to its home position as the engine warms up.

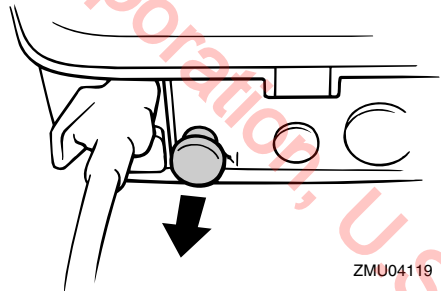

ZMU04119

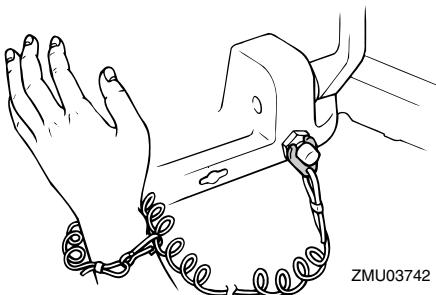

ZMU03742

6. Insert the knotted end of the emergency starter rope into the notch in the flywheel rotor and wind the rope several turns around the flywheel clockwise.
7. Give a strong pull straight out to crank

# Trouble Recovery

and start the engine. Repeat if necessary.

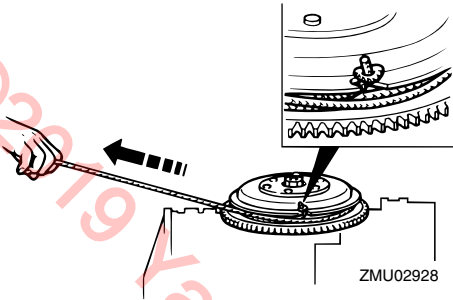

EMU29760

## Treatment of submerged motor

If the outboard motor is submerged, immediately take it to a Yamaha dealer. Otherwise some corrosion may begin almost immediately.

If you cannot immediately take the outboard motor to a Yamaha dealer, follow the procedure below in order to minimize engine damage.

EMU29771

### Procedure

1. Thoroughly wash away mud, salt, seaweed, and so on, with fresh water.



ZMU01909

2. Remove the spark plugs and face the spark plug holes downward to allow any water, mud, or contaminants to drain.

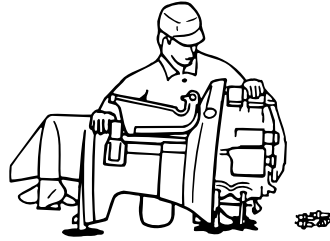

ZMU01910

3. Drain the fuel from the carburetor, fuel filter, and fuel line.
4. Feed fogging oil or engine oil through the carburetor(s) and spark plug holes while cranking with the manual starter or emergency starter rope.

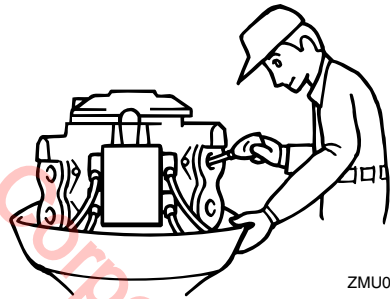

ZMU01911

5. Take the outboard motor to a Yamaha dealer as soon as possible.

ECM00400

### CAUTION:

**Do not attempt to run the outboard motor until it has been completely inspected.**

EMU29811

## Important warranty information for U.S.A. and Canada

Welcome to the Yamaha Family!

**Congratulations on the purchase of your new Yamaha marine power. Yamaha is committed to exceptional customer satisfaction, and we want your ownership experience to be a satisfying one. Please read the following warranty information to help ensure satisfaction with your Yamaha.**

Yamaha is ready to stand behind your purchase with strong warranty coverage. To be sure you receive all the benefits of warranty, please take the following steps:

1. Be sure your new Yamaha is registered for warranty. Your boat dealer should do this at the time of sale. Make sure your dealer gives you a copy of the completed Yamaha registration card for your records. If you are unsure whether or not your Yamaha is registered, complete the Warranty Registration card found inside the cover of the Owner's Manual. Mail it to the distributor for the country in which you live (see step 6 for the correct address). If your Yamaha is not properly registered, a warranty repair could be unnecessarily delayed while registration records are checked.
2. Read the Limited Warranty statement which follows these instructions. This warranty applies to Yamaha outboard motors sold in the United States, whether purchased separately or when supplied as original equipment by a boat builder. The terms also apply to original equipment packages sold in Canada, with coverage provided by Yamaha Motor Canada (see "Warranty Guide" for Canadian models). This warranty explains the conditions of the warranty, including the obligations that your dealer and you as the owner have under the warranty. For example, your Yamaha outboard must receive a proper pre-delivery inspection (PDI) by the selling dealer. Failure to take this important step could jeopardize warranty coverage!
3. If you need warranty repairs, you must take your Yamaha outboard to an authorized Yamaha outboard dealer. Be aware that not all selling boat dealers are authorized Yamaha dealers. Only authorized dealers have the factory training, special tools, and Yamaha support needed to perform warranty repairs.
4. If you are away from home, or your selling dealer is not an authorized Yamaha dealer, use the following toll-free numbers to find the nearest Yamaha dealer.

**United States Dealer Locations: 1-800-692-6242**

**Canada Dealer Locations: 1-800-267-8577**

ZMU01682

# Consumer information

---

5. Your warranty applies specifically to repairs made in the country of purchase. If your U.S.-purchased Yamaha needs warranty service while in Canada, or your Canadian purchased Yamaha needs service while in the United States, Yamaha will assist the local dealer whenever possible. However, some products available in one country may not be sold or serviced in the other.
6. If you need any additional information about your Yamaha or warranty coverage which your dealer cannot provide, please contact us directly.

**Yamaha Motor Corporation, USA.**  
**1270 Chastain Road**  
**Kennesaw, GA 30144**  
**Attention: Customer Relations Department**

**Telephone No. (866) 894-1626**  
**Fax No. (770) 420-6106**

**Yamaha Motor Canada Ltd.**  
**480 Gordon Baker Road**  
**Toronto, Ontario**  
**M2H 3B4**  
**Attention: Customer Relations Department**

**Telephone No. (416) 498-1911**  
**Fax No. (416) 491-3122**

ZMU01683



EMU29820

## YAMAHA MOTOR CORPORATION, U.S.A. OUTBOARD MOTOR TWO YEAR LIMITED WARRANTY

Yamaha Motor Corporation, U.S.A. is proud of its heritage and reputation for producing products with high standards of quality and workmanship. Product excellence provides the cornerstone for our commitment to customer satisfaction. The Yamaha Outboard Limited Warranty is your assurance of this commitment.

This warranty provides you with protection against the expense of repairs for your outboard motor that are required as a result of defects in materials or workmanship. When maintained and utilized in the prescribed manner, you can count on your Yamaha outboard to provide reliable service.

This warranty provides you with specific coverage and notes your responsibilities in maintaining and operating your outboard. Please take the time to read and become familiar with this warranty.

**PERIOD OF WARRANTY.** Any new Yamaha outboard motor purchased and registered with Yamaha Motor Corporation, U.S.A. for pleasure use in the United States, will be warranted against defects in material or workmanship for a period of two (2) years from date of purchase, subject to exclusions noted herein. Any Yamaha outboard motor purchased and utilized for commercial applications will be warranted for a period of one (1) year from the date of purchase, subject to exclusions noted herein. Yamaha peripheral equipment included with the motor, such as gauges, fuel tanks and hoses, remote control boxes, propellers, and wiring external from the motor unit, will be warranted for one (1) year from the date of purchase for either pleasure or commercial use. Replacement parts used in warranty repairs will be warranted for the balance of the applicable warranty period.

The second year of warranty (if applicable) shall be limited to covering the cost of parts and labor for major components only. The major components covered are:

### Power Unit Section

- Power Head
- Intake Manifold and Reed Valve Assembly
- Carburetor Assembly and its Related Components
- Fuel and Oil Pump Assemblies
- Ignition System (Standard and Microcomputer)
- Precision Blend © System

### Bracket Section

- Bracket System
- Power Trim and Tilt Assembly

### Lower Unit Section

- Exhaust System
- Upper Casing
- Lower Unit Assembly

The warranty described here applies to outboard motor purchased and registered for use in the United States only excluding its territories. For warranty provisions outside the United States, contact the particular country's local Yamaha distributor.

**WARRANTY REGISTRATION.** To be eligible for warranty coverage, the outboard motor must first be registered with Yamaha Motor Corporation, U.S.A. A warranty registration form is provided in the Owner's Manual with each outboard. This form must be completed and mailed to Yamaha by either the selling dealer or the purchaser. Warranty registration can also be accomplished by any authorized Yamaha outboard dealer. Upon receipt of the registration, an Owner's Warranty Card will be sent by Yamaha to the registered purchaser.

**OBTAINING REPAIRS UNDER WARRANTY.** To receive repairs under this warranty, a valid Owner's Warranty Card must be presented to an authorized Yamaha outboard dealer.

During the period of warranty, any authorized Yamaha outboard dealer will, free of charge, repair or replace, at Yamaha's option, any parts adjudged defective by Yamaha due to faulty workmanship or material from the factory. All replaced parts will become the property of Yamaha Motor Corporation, U.S.A.

**CUSTOMER'S RESPONSIBILITY.** Under the terms of this warranty, the customer will be responsible for ensuring that the outboard motor is properly operated, maintained and stored as specified in the applicable Owner's Manual.

The owner of the outboard motor shall give notice to an authorized Yamaha marine dealer of any and all apparent defects within ten (10) days of discovery and make the motor available at that time for inspection and repairs at the dealer's place of business.

**GENERAL EXCLUSIONS FROM WARRANTY.** This warranty will not cover the repair of damage if the damage is a result of abuse or neglect of the product. Examples of abuse and neglect include, but are not limited to:

1. Racing or competition use, modification of original parts, abnormal strain.
2. Lack of proper maintenance and off-season storage as described in the Owner's Manual, improper mounting of the motor, installation of parts or accessories that are not equivalent in design and quality to genuine Yamaha parts.
3. Operation of the motor at an rpm other than specified, improper propeller selection, use of lubricants, oils, and fuel/oil mixtures that are not suitable for outboard motor use.
4. Damage as a result of accidents, collisions, contact with foreign materials, or submersion.
5. Growth of marine organisms on motor surfaces.
6. Normal deterioration.

ZMU01684

# Consumer information

---

**SPECIFIC PARTS EXCLUDED FROM WARRANTY.** Parts replaced due to normal wear or routine maintenance such as oil, spark plugs, shear pins, propellers, hubs, fuel and oil filters, brushes for the starter motor and power tilt motor, water pump impellers, and anodes are not covered by warranty. Charges for removal of the motor from a boat and transporting the motor to and from an authorized Yamaha outboard dealer are excluded from warranty coverage.

Specific parts excluded from the second year of warranty (if applicable) are:

- Top and Bottom Cowling
- Electric Components (other than ignition system)
- Rubber Components (such as hoses, tubes, rubber seals, fittings, and clamps)

**TRANSFER OF WARRANTY.** Transfer of the warranty from the original purchaser to any subsequent purchaser is possible by having the motor inspected by an authorized Yamaha outboard dealer and requesting the dealer to submit a change of registration to Yamaha Motor Corporation, U.S.A. within ten (10) days of the transfer.

**EMISSION CONTROL SYSTEM WARRANTY.** Yamaha warrants to the ultimate purchaser and each subsequent purchaser, that this engine is designed, built, and equipped so as to conform at the time of sale with applicable regulations under section 213 of the Clean Air Act and this engine is free from defects in materials and workmanship which cause said engine to fail to conform with applicable regulations for one (1) year from date of purchase.

**YAMAHA MOTOR CORPORATION, U.S.A. MAKES NO OTHER WARRANTY OF ANY KIND, EXPRESSED OR IMPLIED. ALL IMPLIED WARRANTIES OF MERCHANTABILITY AND FITNESS FOR A PARTICULAR PURPOSE WHICH EXCEED THE OBLIGATIONS AND TIME LIMITS STATED IN THIS WARRANTY ARE HEREBY DISCLAIMED BY YAMAHA MOTOR CORPORATION, U.S.A. AND EXCLUDED FROM THIS WARRANTY.**

**SOME STATES DO NOT ALLOW LIMITATIONS ON HOW LONG AN IMPLIED WARRANTY LASTS, SO THE ABOVE LIMITATION MAY NOT APPLY TO YOU. ALSO EXCLUDED FROM THIS WARRANTY ARE ANY INCIDENTAL OR CONSEQUENTIAL DAMAGES INCLUDING LOSS OF USE. SOME STATES DO NOT ALLOW THE EXCLUSION OR LIMITATION OF INCIDENTAL OR CONSEQUENTIAL DAMAGES, SO THE ABOVE EXCLUSION MAY NOT APPLY TO YOU.**

**THIS WARRANTY GIVES YOU SPECIFIC LEGAL RIGHTS, AND YOU MAY ALSO HAVE OTHER RIGHTS WHICH VARY FROM STATE TO STATE.**

**YAMAHA MOTOR CORPORATION, USA.**  
1270 Chastain Road  
Kennesaw, GA 30144

## WARRANTY QUESTIONS AND ANSWERS

- Q. What costs are my responsibility during the warranty period?  
A. The customer's responsibility includes all costs of normal maintenance services, non-warranty repairs, accident and collision damages.
- Q. What are some examples of "abnormal" strain, neglect, or abuse?  
A. These terms are general and overlap each other in areas. Specific examples include:  
Running the machine out of oil, operating the machine with a broken or damaged part which causes another part to fail, damage or failure due to improper or careless transportation, and/or tie down. If you have any specific questions on operation or maintenance, please contact your Yamaha outboard dealer for advice.
- Q. Does the warranty cover incidental costs such as towing or transportation due to a failure?  
A. No. The warranty is limited to repair of the machine itself.
- Q. May I perform any or all of the recommended maintenance shown in the Owner's Manual instead of having the dealer do them?  
A. Yes, if you are a qualified mechanic and follow the procedures specified in the Owner's and Service Manuals. We do recommend, however, that items requiring special tools or equipment be done by a Yamaha outboard dealer.
- Q. Will the warranty be void or canceled if I do not operate or maintain my new outboard exactly as specified in the Owner's Manual?  
A. No. The warranty on a new outboard cannot be "voided" or "canceled". However, if a particular failure is caused by operation or maintenance other than as shown in the Owner's Manual, that failure may not be covered under warranty.
- Q. What responsibility does a Yamaha outboard dealer have under this warranty?  
A. Each Yamaha outboard dealer is expected to:  
1. Completely set up each outboard he sells prior to delivery.  
2. Explain the operation, maintenance, and warranty requirements to your satisfaction at the time of sale, and upon your request at any later date.  
In addition, each Yamaha outboard dealer is held responsible for his setup, service and warranty repair work.
- Q. Is the warranty transferable to second owners?  
A. Yes. The remainder of any existing warranty can be transferred upon request. The unit has to be inspected and re-registered by an authorized Yamaha outboard dealer for the policy to remain effective.

ZMU01685

# Consumer information

## CUSTOMER SERVICE

If your machine requires warranty service, you must take it to any authorized Yamaha outboard dealer within the continental United States. Be sure to bring your warranty registration identification or other valid proof of the original date of purchase. If a question or problem arises regarding warranty, first contact the owner of the dealership. Since all warranty matters are handled at the dealer level, this person is in the best position to help you. If you are still not satisfied and require additional assistance, please write:

YAMAHA MOTOR CORPORATION USA.  
CUSTOMER RELATIONS DEPARTMENT  
1270 Chastain Road  
Kennesaw, GA 30144

When contacting Yamaha Motor Corporation, U.S.A. don't forget to include any important information such as names, addresses, model, engine serial number, dates, and receipts.

## CHANGE OF ADDRESS

The federal government requires each manufacturer of a motor vehicle to maintain a complete, up-to-date list of all first purchasers against the possibility of a safety-related defect and recall. This list is compiled from the purchase registrations sent to Yamaha Motor Corporation, U.S.A. by the selling dealer at the time of your purchase.

If you should move after you have purchased your new outboard, please advise us of your new address by sending a postcard listing your outboard model name, engine serial number, dealer number (or dealer's name) as it is shown on your warranty identification, your name and new mailing address. Mail to:

YAMAHA MOTOR CORPORATION, USA.  
WARRANTY DEPARTMENT  
P.O.Box 6555  
Cypress, California 90630

This will ensure that Yamaha Motor Corporation, U.S.A. has an up-to-date registration record in accordance with federal law.

ZMU01686

# Consumer information

---

EMU29841

## IMPORTANT WARRANTY INFORMATION IF YOU USE YOUR YAMAHA OUTSIDE THE USA OR CANADA

Welcome to the Yamaha Family!

**Congratulations on the purchase of your new Yamaha Products. Yamaha is committed to exceptional customer satisfaction, and we want your ownership experience to be a satisfying one. Please read the following warranty information to help ensure satisfaction with your Yamaha.**

This model was manufactured as a USA specification model, and the warranty statement shown in this manual is for the United States market.

Please note the following information:

1. As explained in the Limited Warranty Statement, the Yamaha warranty covers your Yamaha when it is registered and used in the United States or Canada.
2. If you need repairs while temporarily using your Yamaha in another country, contact the local authorized Yamaha distributor for that country. Yamaha will work with that distributor to make the needed repairs as quickly as possible. If you have to pay for a repair that you believe your warranty would have covered at home, present all repair orders, receipts, or other related documents to your local dealer when you return home. He will be able to contact Yamaha on your behalf to see if any refund can be provided.

### NOTE:

Your Yamaha model may not be sold in some countries. Therefore, a Yamaha dealer outside the United States or Canada may not have all of the replacement parts or technical information available to provide proper service. This may unavoidably delay repairs. Thank you for your understanding should this happen.

---

3. If your Yamaha is registered or used primarily outside the United States or Canada, the warranty printed in this manual does not apply to you. Contact the dealer who sold the Yamaha marine power unit to you for customer support information.

ZMU05199

©2019 Yamaha Motor Corporation, U.S.A.

©2019 Yamaha Motor Corporation, U.S.A.



YAMAHA MOTOR CORPORATION, USA

Printed in Japan

April 2006-0.2 × 1 

Printed on recycled paper

**YAMAHA****OUTBOARD MOTOR WARRANTY REGISTRATION  
ENREGISTREMENT DE LA GARANTIE DU MOTEUR HORS-BORD**

Please complete and mail this card. This information is necessary to accurately register your unit for warranty.  
Veuillez signer ci-dessous pour attester que le montage et l'inspection ont été faits dans le respect des directives d'inspection et que la marche à suivre pour la garantie et l'entretien a été expliquée à l'acheteur au détail.

OUTBOARD MOTOR MODEL AND SERIAL NUMBER (From I.D. label on clamp bracket)  
MODÈLE ET NO. DE SÉRIE DU MOTEUR HORS-BORD (sur l'étiquette d'identification de la presse de fixation)

(For Dealer Use Only)  
(A l'usage du concessionnaire)  
**YAMAHA DEALER NUMBER**  
NO. DU CONCESSIONNAIRE  
YAMAHA

**YAMAHA**

YAMAHA MOTOR CO., LTD.  
MADE IN JAPAN  
PAYS D'ORIGINE JAPON



DEALER NAME  
NOM DU  
CONCESSIONNAIRE

DATE SOLD  
DATE DE  
LIVRAISON

MONTH	DAY	YEAR
MOIS	JOUR	ANNÉE

OWNER'S NAME  
NOM DU  
PROPRIÉTAIRE

FIRST	LAST
PRÉNOM	NOM DE FAMILLE

ADDRESS  
ADRESSE

STREET
RUE

PHONE NUMBER ( )  
NUMÉRO DE TÉLÉPHONE

CITY  
VILLE

STATE/PROVINCE  
PROVINCE

ZIP  
CODE POSTAL

USAGE  
(Check One)  
UTILISATION  
(En cocher un.)

PLEASURE  
LOISIR  
 COMMERCIAL  
COMMERCIAL

PLACE  
POSTAGE  
HERE

**ATTN: WARRANTY DEPARTMENT**